

## Aluminum Electrolytic Capacitors Axial Miniature, Long-Life

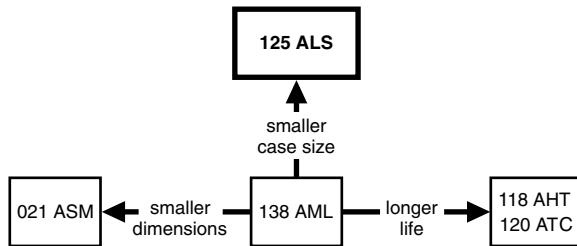

Fig. 1

QUICK REFERENCE DATA	
DESCRIPTION	VALUE
Nominal case sizes (Ø D x L in mm)	6.5 x 18 to 10 x 25      10 x 30 to 21 x 38
Rated capacitance range, C <sub>R</sub>	47 µF to 18 000 µF
Tolerance on C <sub>R</sub>	± 20 %
Rated voltage range, U <sub>R</sub>	10 V to 63 V
Category temperature range	-40 °C to +105 °C
Endurance test at 105 °C	3000 h      5000 h
Useful life at 105 °C	5000 h      10 000 h
Useful life at 40 °C, I <sub>R</sub> applied	1.3 x I <sub>R</sub> applied: 200 000 h      1.8 x I <sub>R</sub> applied: 500 000 h
Shelf life at 0 V, 105 °C	500 h
Based on sectional specification	IEC 60384-4 / EN130 300
Climatic category IEC 60068	40 / 105 / 56

### FEATURES

- Polarized aluminum electrolytic capacitors, non-solid electrolyte
- Axial leads, cylindrical aluminum case, insulated with a blue sleeve
- Mounting ring version not available in insulated form
- Taped versions up to case Ø 15 mm x 30 mm available for automatic insertion
- Charge and discharge proof
- Long useful life: 5000 h to 10 000 h at 105 °C, high reliability
- High ripple current capability
- Miniaturized, high CV-product per unit volume
- AEC-Q200 qualified
- Material categorization: for definitions of compliance please see [www.vishay.com/doc?99912](http://www.vishay.com/doc?99912)

 AUTOMOTIVE  
GRADE

**RoHS**  
COMPLIANT

### APPLICATIONS

- Industrial, automotive, EDP and telecommunication
- Smoothing, filtering, buffering in SMPS; coupling, decoupling, timing
- Portable and mobile equipment (small size, low mass)
- Stand-by applications
- Low mounting height boards, vibration and shock resistant

### MARKING

The capacitors are marked (where possible) with the following information:

- Rated capacitance (in µF)
- Tolerance on rated capacitance, code letter in accordance with IEC 60062 (M for ± 20 %)
- Rated voltage (in V)
- Upper category temperature (105 °C)
- Date code, in accordance with IEC 60062
- Code for factory of origin
- Name of manufacturer
- Negative terminal identification
- Series number (125)

<b>SELECTION CHART FOR <math>C_R</math>, <math>U_R</math>, AND RELEVANT NOMINAL CASE SIZES (<math>\varnothing D \times L</math> in mm)</b>					
$C_R$ ( $\mu F$ )	$U_R$ (V)				
	10	16	25	40	63
47	-	-	-	-	6.5 x 18
82	-	-	-	6.5 x 18	-
100	-	-	-	-	8 x 18
120	-	-	-	-	10 x 18
150	-	-	-	8 x 18	-
180	-	-	6.5 x 18	10 x 18	10 x 25
220	-	-	-	-	10 x 30
270	-	-	-	10 x 25	-
330	-	6.5 x 18	-	-	-
390	-	-	10 x 18	10 x 30	-
470	6.5 x 18	-	-	-	12.5 x 30
560	-	8 x 18	-	-	-
680	-	-	-	-	15 x 30
820	8 x 18	-	10 x 25	12.5 x 30	-
1000	10 x 18	10 x 18	10 x 30	15 x 30	18 x 30
1200	-	10 x 25	-	-	-
1500	10 x 25	-	-	18 x 30	18 x 38
1800	-	10 x 30	-	-	-
2200	10 x 30	-	12.5 x 30	18 x 38	21 x 38
2700	-	12.5 x 30	15 x 30	-	-
3300	-	15 x 30	-	21 x 38	-
3900	12.5 x 30	-	18 x 30	-	-
4700	15 x 30	-	-	-	-
5600	-	18 x 30	-	-	-
6800	-	18 x 30	18 x 38	-	-
8200	18 x 30	-	21 x 38	-	-
10 000	-	18 x 38	-	-	-
12 000	18 x 38	-	-	-	-
15 000	-	21 x 38	-	-	-
18 000	21 x 38	-	-	-	-

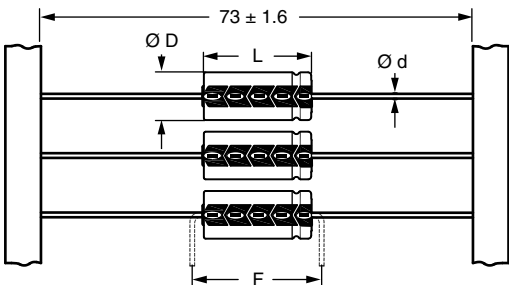
**DIMENSIONS in millimeters AND AVAILABLE FORMS**

**Form BR:** Taped on reel  
 Case  $\varnothing D \times L = 6.5 \text{ mm} \times 18 \text{ mm}$  to  $15 \text{ mm} \times 30 \text{ mm}$   
**Form BA:** Taped in box (ammopack)  
 Case  $\varnothing D \times L = 6.5 \text{ mm} \times 18 \text{ mm}$  to  $10 \text{ mm} \times 25 \text{ mm}$

Fig. 2 - Forms BA and BR

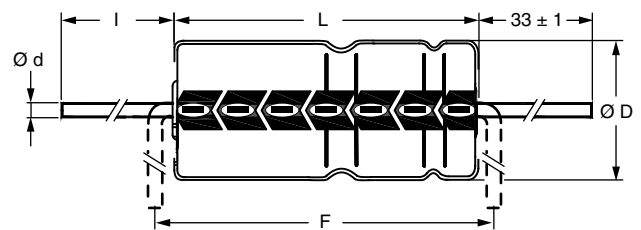

**Form AA:** Axial in box  
 Case  $\varnothing D \times L = 10 \text{ mm} \times 30 \text{ mm}$  to  $21 \text{ mm} \times 38 \text{ mm}$

Fig. 3 - Form AA

**Table 1**

<b>AXIAL; DIMENSIONS</b> in millimeters, <b>MASS AND PACKAGING QUANTITIES</b>										
NOMINAL CASE SIZE Ø D x L (mm)	CASE CODE	AXIAL: FORM AA, BA, AND BR					MASS (g)	PACKAGING QUANTITIES		
		Ø d	l	Ø D <sub>max.</sub>	L <sub>max.</sub>	F <sub>min.</sub>		FORM AA	FORM BA	FORM BR
6.5 x 18	4	0.8	-	6.9	18.5	25	≈ 1.3	-	1000	1000
8 x 18	5	0.8	-	8.5	18.5	25	≈ 1.7	-	500	500
10 x 18	6	0.8	-	10.5	18.5	25	≈ 2.5	-	500	500
10 x 25	7	0.8	-	10.5	25.5	30	≈ 3.3	-	500	500
10 x 30	00	0.8	55 ± 1	10.5	30.5	35	≈ 4.8	340	-	500
12.5 x 30	01	0.8	55 ± 1	13.0	30.5	35	≈ 7.4	260	-	400
15 x 30	02	0.8	55 ± 1	15.5	30.5	35	≈ 11.7	200	-	250
18 x 30	03	0.8	55 ± 1	18.5	30.5	35	≈ 12.9	120	-	-
18 x 38	04	0.8	34 ± 1	18.5	39.5	44	≈ 19.0	125	-	-
21 x 38	05	0.8	34 ± 1	21.5	39.5	44	≈ 24.0	100	-	-

**Note**

- For detailed tape dimensions refer to packaging information: [www.vishay.com/doc?28361](http://www.vishay.com/doc?28361)

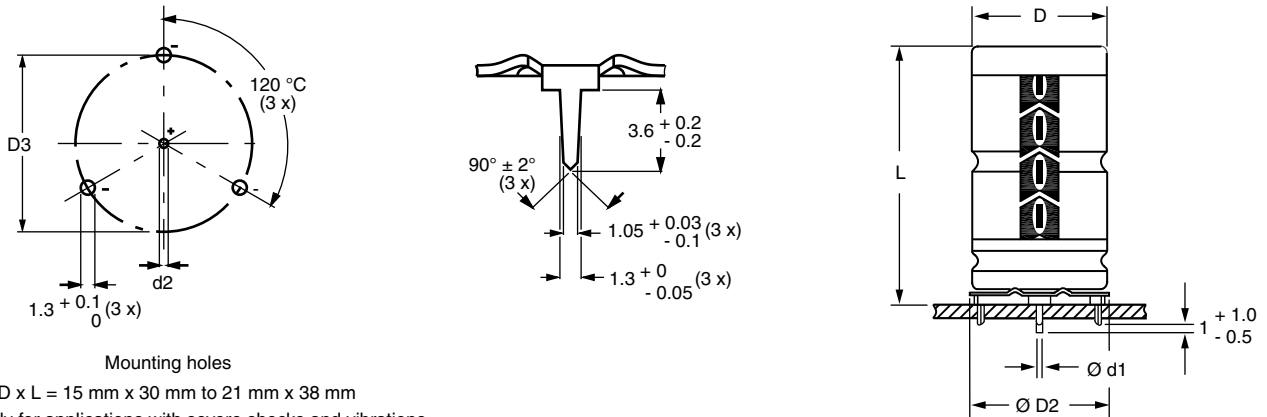

Mounting holes

Case Ø D x L = 15 mm x 30 mm to 21 mm x 38 mm

Especially for applications with severe shocks and vibrations

 Fig. 4 - Mounting hole diagram and outline; **Form MR:** With mounting ring and pins

**Table 2**

<b>MOUNTING RING; DIMENSIONS</b> in millimeters, <b>MASS AND PACKAGING QUANTITIES</b>									
NOMINAL CASE SIZE Ø D x L	CASE CODE	MOUNTING RING: FORM MR						MASS (g)	PACKAGING QUANTITIES
		Ø d1	Ø d2	D <sub>max.</sub>	Ø D2 <sub>max.</sub>	D3	L <sub>max.</sub>		
15 x 30	02	0.8	1.0 + 0.4	15.5	17.5	16.5 ± 0.2	33	≈ 11.7	200
18 x 30	03	0.8	1.0 + 0.4	18.5	19.5	18.5 ± 0.2	33	≈ 12.9	240
18 x 38	04	0.8	1.0 + 0.4	18.5	19.5	18.5 ± 0.2	42	≈ 19.0	100
21 x 38	05	0.8	1.0 + 0.4	21.5	22.5	21.5 ± 0.2	42	≈ 24.0	100



ELECTRICAL DATA	
SYMBOL	DESCRIPTION
$C_R$	Rated capacitance at 100 Hz, tolerance $\pm 20\%$
$I_R$	Rated RMS ripple current at 100 Hz, 105 °C
$I_{L5}$	Max. leakage current after 5 min at $U_R$
$\tan \delta$	Max. dissipation factor at 100 Hz
ESR	Equivalent series resistance at 100 Hz (calculated from $\tan \delta_{max}$ and $C_R$ )
Z	Max. impedance at 10 kHz or 100 kHz

**ORDERING EXAMPLE**

Electrolytic capacitor 125 series

470  $\mu F$  / 10 V;  $\pm 20\%$

Nominal case size:  $\varnothing 6.5$  mm x 18 mm; Form BA

Ordering code: MAL212534471E3

**Note**

- Unless otherwise specified, all electrical values in Table 3 apply at  $T_{amb} = 20\text{ °C}$ ,  $P = 86\text{ kPa}$  to  $106\text{ kPa}$ ,  $RH = 45\%$  to  $75\%$

**Table 3**

ELECTRICAL DATA AND ORDERING INFORMATION											
$U_R$ (V)	$C_R$ 100 Hz ( $\mu F$ )	NOMINAL CASE SIZE $\varnothing D \times L$ (mm)	$I_R$ 10 kHz 105 °C (mA)	$I_{L5}$ 5 min ( $\mu A$ )	$\tan \delta$ 100 Hz	ESR 100 Hz ( $\Omega$ )	Z 10 kHz ( $\Omega$ )	ORDERING CODE MAL2125.....			
								IN BOX FORM AA	TAPED ON REEL FORM BR	TAPED IN BOX FORM BA	MOUNTING RING FORM MR
10	470	6.5 x 18	420	29	0.24	0.564	0.91	-	24471E3	34471E3	-
	820	8 x 18	660	37	0.24	0.308	0.43	-	24821E3	34821E3	-
	1000	10 x 18	900	40	0.26	0.292	0.35	-	24102E3	34102E3	-
	1500	10 x 25	1140	50	0.26	0.195	0.2	-	24152E3	34152E3	-
	2200	10 x 30	2200	64	0.24	0.145	0.26	14222E3	24222E3	-	-
	3900	12.5 x 30	2750	98	0.26	0.088	0.19	14392E3	24392E3	-	-
	4700	15 x 30	3080	114	0.28	0.079	0.13	14472E3	24472E3	-	44472E3
	8200	18 x 30	3360	192	0.36	0.056	0.11	14822E3	-	-	44822E3
	12 000	18 x 38	4230	260	0.44	0.049	0.074	14123E3	-	-	44123E3
	18 000	21 x 38	4790	380	0.56	0.041	0.058	14183E3	-	-	44183E3
16	330	6.5 x 18	400	31	0.20	0.643	1.25	-	25331E3	35331E3	-
	560	8 x 18	510	38	0.20	0.379	0.73	-	25561E3	35561E3	-
	1000	10 x 18	730	52	0.22	0.239	0.34	-	25102E3	35102E3	-
	1200	10 x 25	1080	58	0.22	0.199	0.3	-	25122E3	35122E3	-
	1800	10 x 30	2100	78	0.18	0.133	0.27	15182E3	25182E3	-	-
	2700	12.5 x 30	2650	106	0.20	0.098	0.19	15272E3	25272E3	-	-
	3300	15 x 30	2940	126	0.22	0.088	0.14	15332E3	25332E3	-	45332E3
	5600	18 x 30	3290	199	0.26	0.062	0.1	15562E3	-	-	45562E3
	6800	18 x 30	3430	238	0.28	0.055	0.1	15682E3	-	-	45682E3
	10 000	18 x 38	4350	340	0.36	0.048	0.062	15103E3	-	-	45103E3
15 000	21 x 38	4590	500	0.46	0.041	0.057	15153E3	-	-	45153E3	
25	180	6.5 x 18	350	29	0.18	1.032	1.2	-	26181E3	36181E3	-
	390	10 x 18	600	40	0.18	0.476	0.55	-	26391E3	36391E3	-
	820	10 x 25	970	61	0.18	0.226	0.26	-	26821E3	36821E3	-
	1000	10 x 30	2100	70	0.16	0.212	0.26	16102E3	26102E3	-	-
	2200	12.5 x 30	2600	130	0.18	0.109	0.18	16222E3	26222E3	-	-
	2700	15 x 30	3740	155	0.18	0.088	0.13	16272E3	26272E3	-	46272E3
	3900	18 x 30	4310	215	0.20	0.068	0.1	16392E3	-	-	46392E3
	6800	18 x 38	4350	360	0.26	0.051	0.071	16682E3	-	-	46682E3
	8200	21 x 38	4470	450	0.30	0.046	0.058	16822E3	-	-	46822E3



ELECTRICAL DATA AND ORDERING INFORMATION											
U <sub>R</sub> (V)	C <sub>R</sub> 100 Hz (μF)	NOMINAL CASE SIZE Ø D x L (mm)	I <sub>R</sub> 10 kHz 105 °C (mA)	I <sub>L5</sub> 5 min (μA)	tan δ 100 Hz	ESR 100 Hz (Ω)	Z 10 kHz (Ω)	ORDERING CODE MAL2125.....			
								IN BOX FORM AA	TAPED ON REEL FORM BR	TAPED IN BOX FORM BA	MOUNTING RING FORM MR
40	82	6.5 x 18	270	27	0.10	1.617	2.1	-	27829E3	37829E3	-
	150	8 x 18	400	32	0.10	0.884	1.2	-	27151E3	37151E3	-
	180	10 x 18	550	34	0.10	0.737	0.615	-	27181E3	37181E3	-
	270	10 x 25	780	42	0.10	0.474	0.41	-	27271E3	37271E3	-
	390	10 x 30	1990	51	0.10	0.34	0.32	17391E3	27391E3	-	-
	820	12.5 x 30	2550	81	0.10	0.175	0.18	17821E3	27821E3	-	-
	1000	15 x 30	2840	100	0.12	0.159	0.12	17102E3	27102E3	-	47102E3
	1500	18 x 30	3150	140	0.12	0.106	0.098	17152E3	-	-	47152E3
	2200	18 x 38	4130	196	0.14	0.084	0.069	17222E3	-	-	47222E3
	3300	21 x 38	4170	284	0.16	0.064	0.061	17332E3	-	-	47332E3
63	47	6.5 x 18	230	26	0.08	2.258	3.6	-	28479E3	38479E3	-
	100	8 x 18	340	33	0.08	1.061	1.7	-	28101E3	38101E3	-
	120	10 x 18	530	35	0.08	0.884	1.2	-	28121E3	38121E3	-
	180	10 x 25	720	43	0.08	0.589	0.8	-	28181E3	38181E3	-
	220	10 x 30	1560	48	0.08	0.482	0.44	18221E3	28221E3	-	-
	470	12.5 x 30	2150	79	0.08	0.226	0.31	18471E3	28471E3	-	-
	680	15 x 30	2510	106	0.08	0.156	0.16	18681E3	28681E3	-	48681E3
	1000	18 x 30	2860	146	0.10	0.133	0.12	18102E3	-	-	48102E3
	1500	18 x 38	3720	209	0.10	0.088	0.086	18152E3	-	-	48152E3
	2200	21 x 38	3780	297	0.12	0.072	0.072	18222E3	-	-	48222E3

ADDITIONAL ELECTRICAL DATA			
PARAMETER	CONDITIONS	VALUE	
		AXIAL	MOUNTING RING
<b>Voltage</b>			
Surge voltage		U <sub>s</sub> ≤ 1.15 x U <sub>R</sub>	
Reverse voltage		U <sub>rev</sub> ≤ 1 V	
<b>Current</b>			
Leakage current	After 1 min at U <sub>R</sub>	I <sub>L1</sub> ≤ 0.006 C <sub>R</sub> x U <sub>R</sub> + 20 μA	
	After 5 min at U <sub>R</sub>	I <sub>L5</sub> ≤ 0.002 C <sub>R</sub> x U <sub>R</sub> + 20 μA	
<b>Inductance</b>			
Equivalent series inductance (ESL)	Case Ø D x L mm:		
	6.5 x 18	Typ. 15 nH	-
	8 x 18	Typ. 35 nH	-
	10 x 18	Typ. 69 nH	-
	10 x 25	Typ. 38 nH	-
	10 x 30	Typ. 38 nH	-
	12.5 x 30	Typ. 46 nH	-
	15 x 30	Typ. 48 nH	Typ. 39 nH
	18 x 30	Typ. 50 nH	Typ. 39 nH
	18 x 38	Typ. 54 nH	Typ. 39 nH
21 x 38	Typ. 59 nH	Typ. 39 nH	

**CAPACITANCE (C)**

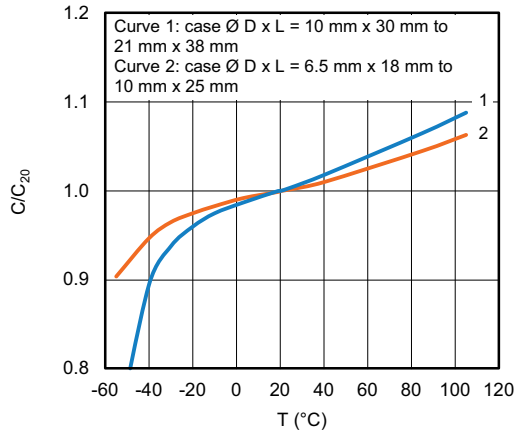

Fig. 5 - Typical multiplier of capacitance as a function of ambient temperature ( $C_{20}$  = capacitance at 20 °C, 100 Hz)

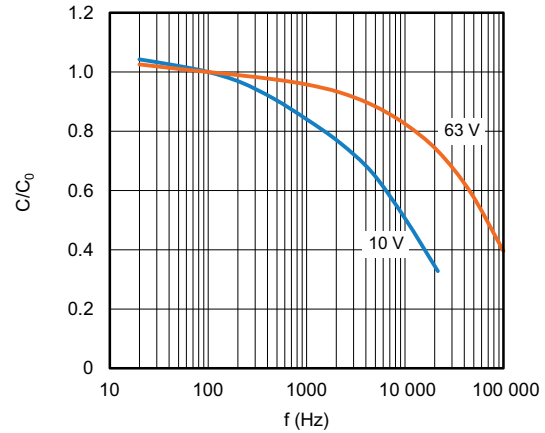

Fig. 6 - Typical multiplier of capacitance as a function of frequency ( $C_0$  = typical capacitance at 100 Hz at 20 °C)

**EQUIVALENT SERIES RESISTANCE (ESR)**

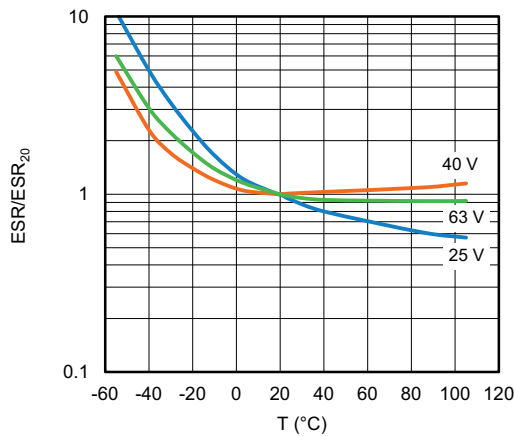

Fig. 7 - Typical multiplier of ESR as a function of ambient temperature ( $ESR_{20}$  = typical ESR at 100 Hz at 20 °C)

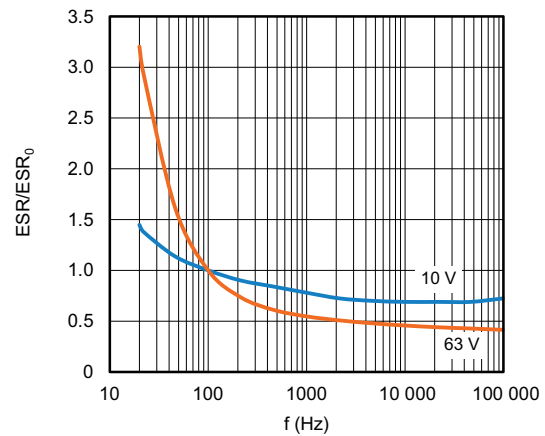

Fig. 8 - Typical multiplier of ESR as a function of frequency ( $ESR_0$  = typical ESR at 100 Hz at 20 °C)

**IMPEDANCE (Z)**

Table 4

<b>IMPEDANCE VS. CAPACITANCE VALUES</b> (Case Ø D x L = 6.5 mm x 18 mm to 10 mm x 25 mm)					
$T_{amb}$	$Z \times C_R (\Omega \times \mu F)$ AT 10 kHz				
	10 V	16 V	25 V	40 V	63 V
+20 °C	≤ 200	≤ 160	≤ 120	≤ 90	≤ 80
-25 °C	≤ 1200	≤ 750	≤ 560	≤ 450	≤ 550
-40 °C	≤ 3200	≤ 2000	≤ 1500	≤ 1200	≤ 1500

**RIPPLE CURRENT AND USEFUL LIFE**

Table 5

ENDURANCE TEST DURATION AND USEFUL LIFE		
NOMINAL CASE SIZE Ø D x L (mm)	ENDURANCE AT 105 °C (h)	USEFUL LIFE AT 105 °C (h)
6.5 x 18	3000	5000
8 x 18	3000	5000
10 x 18	3000	5000
10 x 25	3000	5000
10 x 30	5000	10 000
12.5 x 30	5000	10 000
15 x 30	5000	10 000
18 x 30	5000	10 000
18 x 38	5000	10 000
21 x 38	5000	10 000

**Note**

- Multiplier of useful life code: CCC206

CCC206

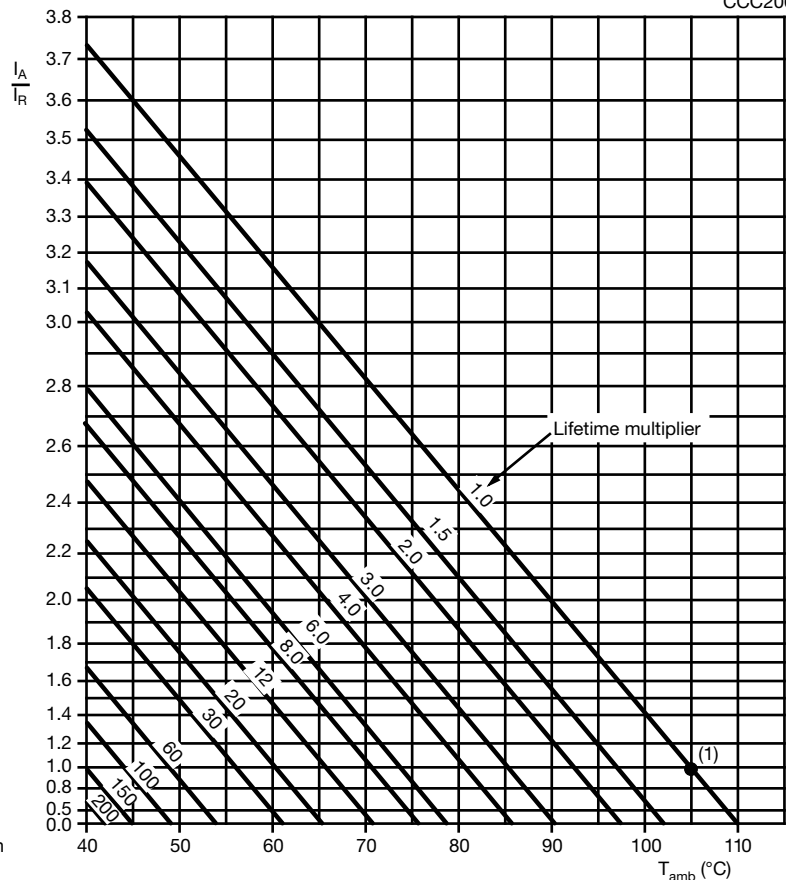

$I_A$  = actual ripple current at 100 Hz  
 $I_R$  = rated ripple current at 100 Hz, 105 °C

<sup>(1)</sup> Useful life at 105 °C and  $I_R$  applied:  
 Case Ø D x L = 6.5 mm x 18 mm to 10 mm x 25 mm: 5000 h  
 Case Ø D x L = 10 mm x 30 mm to 21 mm x 38 mm: 10 000 h

Fig. 9 - Multiplier of useful life as a function of ambient temperature and ripple current load

Table 6

<b>MULTIPLIER OF RIPPLE CURRENT (<math>I_R</math>) AS A FUNCTION OF FREQUENCY</b>						
$U_R$ (V)	FREQUENCY (Hz)					
	50	100	300	1000	3000	$\geq 10\ 000$
$I_R$ MULTIPLIER						
10	0.79	0.83	0.89	0.93	0.96	1.00
16	0.69	0.77	0.86	0.92	0.96	1.00
25	0.69	0.77	0.86	0.92	0.96	1.00
40	0.61	0.71	0.86	0.93	0.96	1.00
63	0.61	0.71	0.86	0.93	0.96	1.00

Table 7

<b>TEST PROCEDURES AND REQUIREMENTS</b>			
TEST		PROCEDURE (quick reference)	REQUIREMENTS
NAME OF TEST	REFERENCE		
Endurance	IEC 60384-4 / EN130300 subclause 4.13	$T_{amb} = 105\ ^\circ\text{C}$ ; $U_R$ applied; Case $\emptyset$ D x L: 6.5 mm x 18 mm to 10 mm x 25 mm: 3000 h; 10 mm x 30 mm to 21 mm x 38 mm: 5000 h	$U_R \leq 10\ \text{V}$ ; $\Delta\text{C}/\text{C}$ : +15 % / -30 % $U_R > 10\ \text{V}$ ; $\Delta\text{C}/\text{C}$ : $\pm 15\ \%$ $\tan \delta \leq 1.3 \times \text{spec. limit}$ $Z \leq 2 \times \text{spec. limit}$ $I_{L5} \leq \text{spec. limit}$
Useful life	CECC 30301 subclause 1.8.1	$T_{amb} = 105\ ^\circ\text{C}$ ; $U_R$ and $I_R$ applied; Case $\emptyset$ D x L: 6.5 mm x 18 mm to 10 mm x 25 mm: 5000 h; 10 mm x 30 mm to 21 mm x 38 mm: 10 000 h	$U_R \leq 10\ \text{V}$ ; $\Delta\text{C}/\text{C}$ : +45 % / -50 % $U_R > 10\ \text{V}$ ; $\Delta\text{C}/\text{C}$ : $\pm 45\ \%$ $\tan \delta \leq 3 \times \text{spec. limit}$ $Z \leq 3 \times \text{spec. limit}$ $I_{L5} \leq \text{spec. limit}$ no short open circuit total failure percentage: $\leq 1\ \%$
Shelf life (storage at high temperature)	IEC 60384-4 / EN130300, subclause 4.17	$T_{amb} = 105\ ^\circ\text{C}$ ; no voltage applied; 500 h After test: $U_R$ to be applied for 30 min, 24 h to 48 h before measurement	$\Delta\text{C}/\text{C}$ , $\tan \delta$ , Z: for requirements see "Endurance test" above $I_{L5} \leq 2 \times \text{spec. limit}$

Statements about product lifetime are based on calculations and internal testing. They should only be interpreted as estimations. Also due to external factors, the lifetime in the field application may deviate from the calculated lifetime. In general, nothing stated herein shall be construed as a guarantee of durability.





## Disclaimer

ALL PRODUCT, PRODUCT SPECIFICATIONS AND DATA ARE SUBJECT TO CHANGE WITHOUT NOTICE TO IMPROVE RELIABILITY, FUNCTION OR DESIGN OR OTHERWISE.

Vishay Intertechnology, Inc., its affiliates, agents, and employees, and all persons acting on its or their behalf (collectively, "Vishay"), disclaim any and all liability for any errors, inaccuracies or incompleteness contained in any datasheet or in any other disclosure relating to any product.

Vishay makes no warranty, representation or guarantee regarding the suitability of the products for any particular purpose or the continuing production of any product. To the maximum extent permitted by applicable law, Vishay disclaims (i) any and all liability arising out of the application or use of any product, (ii) any and all liability, including without limitation special, consequential or incidental damages, and (iii) any and all implied warranties, including warranties of fitness for particular purpose, non-infringement and merchantability.

Statements regarding the suitability of products for certain types of applications are based on Vishay's knowledge of typical requirements that are often placed on Vishay products in generic applications. Such statements are not binding statements about the suitability of products for a particular application. It is the customer's responsibility to validate that a particular product with the properties described in the product specification is suitable for use in a particular application. Parameters provided in datasheets and / or specifications may vary in different applications and performance may vary over time. All operating parameters, including typical parameters, must be validated for each customer application by the customer's technical experts. Product specifications do not expand or otherwise modify Vishay's terms and conditions of purchase, including but not limited to the warranty expressed therein.

Hyperlinks included in this datasheet may direct users to third-party websites. These links are provided as a convenience and for informational purposes only. Inclusion of these hyperlinks does not constitute an endorsement or an approval by Vishay of any of the products, services or opinions of the corporation, organization or individual associated with the third-party website. Vishay disclaims any and all liability and bears no responsibility for the accuracy, legality or content of the third-party website or for that of subsequent links.

Except as expressly indicated in writing, Vishay products are not designed for use in medical, life-saving, or life-sustaining applications or for any other application in which the failure of the Vishay product could result in personal injury or death. Customers using or selling Vishay products not expressly indicated for use in such applications do so at their own risk. Please contact authorized Vishay personnel to obtain written terms and conditions regarding products designed for such applications.

No license, express or implied, by estoppel or otherwise, to any intellectual property rights is granted by this document or by any conduct of Vishay. Product names and markings noted herein may be trademarks of their respective owners.