

VDR Metal Oxide Varistors High Surge



LINKS TO ADDITIONAL RESOURCES



QUICK REFERENCE DATA		
PARAMETER	VALUE	UNIT
Maximum continuous voltage in operating temperature range:		
RMS	11 to 680	V
DC	14 to 895	V
Maximum non-repetitive transient current I_{NRP} (8 x 20 μ s)	250 to 10 000	A
Maximum energy (10/1000 μ s)	0.7 to 620	J
Detailed specification	Based on IEC 61051-1 IEC 61051-2 IEC 61051-2-2	
Storage temperature	-40 to +150	$^{\circ}$ C
Operating temperature	-40 to +125	$^{\circ}$ C

ORDERING INFORMATION

The varistors are available in a number of packaging options:

- Bulk
- On tape on reel
- On tape in ammpack (fanfold)

The basic ordering code for each option is given in tables titled Varistors on Tape on Reel, Varistors on Tape in Ammpack, and Varistors in Bulk. To complete the catalog number and to determine the required operating parameters, see Electrical Data and Ordering Information table.

Note

- Special lead-configuration as inside or outside crimped leads on request

AGENCY APPROVALS

- cUL certificate
- ULus certificate
- VDE/IEC certificate

Note

- Agency approval documents, please see: www.vishay.com/ppg?29082&documents

FEATURES

- Low β high purity zinc oxide disc
- Halogen free insulating epoxy coating
- Straight or kinked leads
- Higher current surge/size ratio capability up to 10 kA for H20 types
- Certified for operation up to 85 $^{\circ}$ C according to UL 1449 edition 4, VDE/IEC 61051-1/2
- Material categorization: for definitions of compliance please see www.vishay.com/doc?99912



APPLICATION

- Overvoltage and transient voltage protection

DESCRIPTION

The varistors consist of a disc of low- β ceramic material with two solid copper leads (H20 types only) or copper clad steel wire. The wires have a matte tin plating. They are coated with UL 94 V-0 approved ochre colored halogen-free epoxy, which provides electrical, mechanical and climatic protection. The encapsulation is resistant to all cleaning solvents in accordance with IEC 60068-2-45.

MOUNTING

The varistors are suitable for hand-mounting (bulk) or automatic pick and place mounting (tape on reel or fanfold). The parts can be soldered by hand or wave soldering. Pin-in-paste reflow soldering is not recommended. Bending of the leads for different angle placement is not recommended.

Typical Soldering

235 $^{\circ}$ C, duration: 5 s (Pb-bearing)
245 $^{\circ}$ C, duration: 5 s (lead (Pb)-free)

Resistance to Soldering Heat

260 $^{\circ}$ C, duration: 10 s max.

MARKING

The varistors are marked with the following information:

- Maximum continuous RMS voltage with - E suffix
- Series numbers
 - 582 for VDRH05
 - 583 for VDRH07
 - 584 for VDRH10
 - 585 for VDRH14
 - 586 for VDRH20
- Manufacture logo
- Date of manufacture (YYWW)
- Safety marks on VDRH10-14-20 types

INFLAMMABILITY

The varistors are passive non-flammable. The encapsulation is made of flame resistant epoxy in accordance with UL 94 V-0.



ELECTRICAL DATA AND ORDERING INFORMATION											
MAXIMUM CONTINUOUS VOLTAGE		VOLTAGE ⁽³⁾ AT 1 mA	MAXIMUM VOLTAGE AT STATED CURRENT		MAXIMUM ENERGY ⁽⁴⁾ (10 x 1000 µs)	MAXIMUM NON-REP. TRANSIENT CURRENT ⁽⁵⁾ I _{NRP} (8 x 20 µs)	NOMINAL DISCHARGE CURRENT ⁽⁷⁾ I _N	TYPICAL CAPACITANCE AT 1 kHz	T (max.)	E	SAP MATERIAL AND ORDERING NUMBER ⁽¹⁾ xy ⁽⁶⁾
RMS ⁽²⁾ (V)	DC (V)	(V)	V (V)	I (A)	(J)	(A)	(kA)	(pF)	(mm)	(mm)	
11	14	18	40	1.0	0.7	250	0.10	1600	3.4	0.5 ± 0.3	VDRH05B011xyE
			36	2.5	1.5	500	0.15	3600	3.4	0.5 ± 0.3	VDRH07D011xyE
			36	5.0	2.6	1000	0.50	8000	3.8	0.7 ± 0.3	VDRH10G011xyE
			36	10.0	5.2	2000	1.00	20 000	3.8	0.7 ± 0.3	VDRH14M011xyE
14	18	22	48	1.0	0.8	250	0.10	1300	3.4	0.7 ± 0.3	VDRH05B014xyE
			43	2.5	1.7	500	0.15	2800	3.4	0.7 ± 0.3	VDRH07D014xyE
			43	5.0	3.2	1000	0.50	6000	3.8	0.9 ± 0.3	VDRH10G014xyE
			43	10.0	6.3	2000	1.00	15 000	3.8	0.9 ± 0.3	VDRH14M014xyE
			43	20.0	16.0	3000	2.00	30 000	4.2	1.1 ± 0.3	VDRH20R014ByE
17	22	27	60	1.0	1.1	250	0.10	1050	3.7	0.8 ± 0.3	VDRH05B017xyE
			53	2.5	2.1	500	0.15	2000	3.7	0.8 ± 0.3	VDRH07D017xyE
			53	5.0	3.9	1000	0.50	4000	4.1	1.0 ± 0.3	VDRH10G017xyE
			53	10.0	7.8	2000	1.00	10 000	4.1	1.0 ± 0.3	VDRH14M017xyE
			53	20.0	19.0	3000	2.00	20 000	4.5	1.2 ± 0.3	VDRH20R017ByE
20	26	33	73	1.0	1.3	250	0.10	900	3.9	1.0 ± 0.3	VDRH05B020xyE
			65	2.5	2.8	500	0.15	1500	3.9	1.0 ± 0.3	VDRH07D020xyE
			65	5.0	4.8	1000	0.50	3000	4.3	1.2 ± 0.3	VDRH10G020xyE
			65	10.0	9.5	2000	1.00	7500	4.3	1.2 ± 0.3	VDRH14M020xyE
			65	20.0	24.0	3000	2.00	15 000	4.7	1.4 ± 0.3	VDRH20R020ByE
25	31	39	86	1.0	1.5	250	0.10	500	4.2	1.2 ± 0.3	VDRH05B025xyE
			77	2.5	3.0	500	0.15	1350	4.2	1.2 ± 0.3	VDRH07D025xyE
			77	5.0	5.6	1000	0.50	2600	4.6	1.4 ± 0.3	VDRH10G025xyE
			77	10.0	11.0	2000	1.00	6500	4.6	1.4 ± 0.3	VDRH14M025xyE
			77	20.0	28.0	3000	2.00	13 000	5.0	1.6 ± 0.3	VDRH20R025ByE
30	38	47	104	1.0	1.8	250	0.10	700	4.4	1.4 ± 0.5	VDRH05B030xyE
			93	2.5	3.8	500	0.15	1600	4.4	1.4 ± 0.5	VDRH07D030xyE
			93	5.0	6.8	1000	0.50	2700	4.8	1.6 ± 0.5	VDRH10G030xyE
			93	10.0	14.0	2000	1.00	6000	4.8	1.6 ± 0.5	VDRH14M030xyE
			93	20.0	34.0	3000	2.00	12 000	5.2	1.8 ± 0.5	VDRH20R030ByE
35	45	56	123	1.0	2.2	250	0.10	560	4.8	1.7 ± 0.5	VDRH05B035xyE
			110	2.5	4.4	500	0.15	1300	4.8	1.7 ± 0.5	VDRH07D035xyE
			110	5.0	8.1	1000	0.50	2200	5.2	1.9 ± 0.5	VDRH10G035xyE
			110	10.0	16.0	2000	1.00	4800	5.2	1.9 ± 0.5	VDRH14M035xyE
			110	20.0	41.0	3000	2.00	9600	5.6	2.1 ± 0.5	VDRH20R035ByE
40	56	68	150	1.0	2.6	250	0.10	460	5.1	2.1 ± 0.5	VDRH05B040xyE
			135	2.5	5.4	500	0.15	1000	5.1	2.1 ± 0.5	VDRH07D040xyE
			135	5.0	9.8	1000	0.50	1800	5.5	2.3 ± 0.5	VDRH10G040xyE
			135	10.0	20.0	2000	1.00	3800	5.5	2.3 ± 0.5	VDRH14M040xyE
			135	20.0	49.0	3000	2.00	7600	5.9	2.5 ± 0.5	VDRH20R040ByE
50	65	82	145	5.0	3.5	800	0.10	370	3.5	0.6 ± 0.3	VDRH05E050xyE
			135	10.0	7.0	1750	1.00	900	3.5	0.6 ± 0.3	VDRH07K050xyE
			135	25.0	14.0	3500	1.50	1500	3.9	0.8 ± 0.3	VDRH10S050xyE
			135	50.0	28.0	6000	3.00	3100	3.9	0.8 ± 0.3	VDRH14V050xyE



ELECTRICAL DATA AND ORDERING INFORMATION											
MAXIMUM CONTINUOUS VOLTAGE		VOLTAGE ⁽³⁾ AT 1 mA	MAXIMUM VOLTAGE AT STATED CURRENT		MAXIMUM ENERGY ⁽⁴⁾ (10 x 1000 µs)	MAXIMUM NON-REP. TRANSIENT CURRENT ⁽⁵⁾ I _{NRP} (8 x 20 µs)	NOMINAL DISCHARGE CURRENT ⁽⁷⁾ I _N	TYPICAL CAPACITANCE AT 1 kHz	T (max.)	E	SAP MATERIAL AND ORDERING NUMBER ⁽¹⁾ xy ⁽⁶⁾
RMS ⁽²⁾ (V)	DC (V)	(V)	V (V)	I (A)	(J)	(A)	(kA)	(pF)	(mm)	(mm)	
60	85	100	175	5.0	4.5	800	0.10	290	3.7	0.7 ± 0.3	VDRH05E060xyE
			165	10.0	9.0	1750	1.00	700	3.7	0.7 ± 0.3	VDRH07K060xyE
			165	25.0	18.0	3500	1.50	1200	4.1	0.9 ± 0.3	VDRH10S060xyE
			165	50.0	36.0	6000	3.00	2300	4.1	0.9 ± 0.3	VDRH14V060xyE
			165	100.0	72.0	10 000	5.00	4600	4.5	1.1 ± 0.3	VDRH20X060ByE
75	100	120	210	5.0	5.5	800	0.10	240	4.0	0.9 ± 0.3	VDRH05E075xyE
			200	10.0	11.0	1750	1.00	530	4.0	0.9 ± 0.3	VDRH07K075xyE
			200	25.0	22.0	3500	1.50	1000	4.4	1.1 ± 0.3	VDRH10S075xyE
			200	50.0	44.0	6000	3.00	1900	4.4	1.1 ± 0.3	VDRH14V075xyE
			200	100.0	88.0	10 000	5.00	3800	4.8	1.3 ± 0.3	VDRH20X075ByE
95	125	150	260	5.0	6.5	800	0.10	180	4.2	1.1 ± 0.3	VDRH05E095xyE
			250	10.0	13.0	1750	1.00	450	4.2	1.1 ± 0.3	VDRH07K095xyE
			250	25.0	25.0	3500	1.50	800	4.6	1.3 ± 0.3	VDRH10S095xyE
			250	50.0	53.0	6000	3.00	1500	4.6	1.3 ± 0.3	VDRH14V095xyE
			250	100.0	106.0	10 000	5.00	3000	5.0	1.5 ± 0.3	VDRH20X095ByE
115	150	180	320	5.0	8.0	800	0.10	150	3.6	0.9 ± 0.3	VDRH05E115xyE
			300	10.0	16.0	1750	1.00	390	3.6	0.9 ± 0.3	VDRH07K115xyE
			300	25.0	32.0	3500	1.50	680	4.0	1.1 ± 0.3	VDRH10S115xyE
			300	50.0	65.0	6000	3.00	1320	4.0	1.1 ± 0.3	VDRH14V115xyE
			300	100.0	130.0	10 000	5.00	2640	4.4	1.3 ± 0.3	VDRH20X115ByE
130	170	205	355	5.0	8.5	800	0.10	130	3.8	1.0 ± 0.3	VDRH05E130xyE
			340	10.0	17.5	1750	1.00	320	3.8	1.0 ± 0.3	VDRH07K130xyE
			340	25.0	35.0	3500	1.50	580	4.3	1.2 ± 0.3	VDRH10S130xyE
			340	50.0	70.0	6000	3.00	1050	4.3	1.2 ± 0.3	VDRH14V130xyE
			340	100.0	140.0	10 000	5.00	2100	4.8	1.4 ± 0.3	VDRH20X130ByE
140	180	220	380	5.0	9.0	800	0.10	120	3.9	1.0 ± 0.3	VDRH05E140xyE
			360	10.0	19.0	1750	1.00	290	3.9	1.0 ± 0.3	VDRH07K140xyE
			360	25.0	39.0	3500	1.50	540	4.3	1.2 ± 0.3	VDRH10S140xyE
			360	50.0	78.0	6000	3.00	950	4.3	1.2 ± 0.3	VDRH14V140xyE
			360	100.0	155.0	10 000	5.00	1900	4.8	1.5 ± 0.3	VDRH20X140ByE
150	200	240	415	5.0	10.5	800	0.10	110	4.1	1.1 ± 0.3	VDRH05E150xyE
			395	10.0	21.0	1750	1.00	270	4.1	1.1 ± 0.3	VDRH07K150xyE
			395	25.0	42.0	3500	1.50	490	4.3	1.3 ± 0.3	VDRH10S150xyE
			395	50.0	84.0	6000	3.00	850	4.3	1.3 ± 0.3	VDRH14V150xyE
			395	100.0	168.0	10 000	5.00	1700	4.8	1.5 ± 0.3	VDRH20X150ByE
175	225	275	475	5.0	11.0	800	0.10	90	4.1	1.3 ± 0.3	VDRH05E175xyE
			455	10.0	24.0	1750	1.00	230	4.1	1.3 ± 0.3	VDRH07K175xyE
			455	25.0	49.0	3500	1.50	430	4.5	1.5 ± 0.3	VDRH10S175xyE
			455	50.0	99.0	6000	3.00	750	4.5	1.5 ± 0.3	VDRH14V175xyE
			455	100.0	190.0	10 000	5.00	1500	4.9	1.7 ± 0.3	VDRH20X175ByE
195	250	300	525	5.0	12.0	800	0.10	80	4.3	1.4 ± 0.8	VDRH05E195xyE
			505	10.0	26.0	1750	1.00	210	4.3	1.4 ± 0.8	VDRH07K195xyE
			505	25.0	52.0	3500	1.50	380	4.8	1.6 ± 0.8	VDRH10S195xyE
			505	50.0	105.0	6000	3.00	690	4.8	1.6 ± 0.8	VDRH14V195xyE
			505	100.0	210.0	10 000	5.00	1350	5.1	1.9 ± 0.8	VDRH20X195ByE



ELECTRICAL DATA AND ORDERING INFORMATION											
MAXIMUM CONTINUOUS VOLTAGE		VOLTAGE ⁽³⁾ AT 1 mA	MAXIMUM VOLTAGE AT STATED CURRENT		MAXIMUM ENERGY ⁽⁴⁾ (10 x 1000 μs)	MAXIMUM NON-REP. TRANSIENT CURRENT ⁽⁵⁾ I _{NRP} (8 x 20 μs)	NOMINAL DISCHARGE CURRENT ⁽⁷⁾ I _N	TYPICAL CAPACITANCE AT 1 kHz	T (max.)	E	SAP MATERIAL AND ORDERING NUMBER ⁽¹⁾ xy ⁽⁶⁾
RMS ⁽²⁾ (V)	DC (V)	(V)	V (V)	I (A)	(J)	(A)	(kA)	(pF)	(mm)	(mm)	
210	275	330	575	5.0	13.0	800	0.10	75	4.4	1.6 ± 0.8	VDRH05E210xyE
			550	10.0	28.0	1750	1.00	190	4.4	1.6 ± 0.8	VDRH07K210xyE
			550	25.0	58.0	3500	1.50	350	4.8	1.8 ± 0.8	VDRH10S210xyE
			550	50.0	115.0	6000	3.00	610	4.8	1.8 ± 0.8	VDRH14V210xyE
			550	100.0	228.0	10 000	5.00	1250	5.3	2.0 ± 0.8	VDRH20X210ByE
230	300	360	620	5.0	16.0	800	0.10	70	4.6	1.7 ± 0.8	VDRH05E230xyE
			595	10.0	32.0	1750	1.00	170	4.6	1.7 ± 0.8	VDRH07K230xyE
			595	25.0	65.0	3500	1.50	320	5.1	1.9 ± 0.8	VDRH10S230xyE
			595	50.0	130.0	6000	3.00	540	5.1	1.9 ± 0.8	VDRH14V230xyE
			595	100.0	255.0	10 000	5.00	1100	5.4	2.2 ± 0.8	VDRH20X230ByE
250	320	390	675	5.0	17.0	800	0.10	60	4.8	1.9 ± 0.8	VDRH05E250xyE
			650	10.0	35.0	1750	1.00	160	4.8	1.9 ± 0.8	VDRH07K250xyE
			650	25.0	70.0	3500	1.50	300	5.1	2.1 ± 0.8	VDRH10S250xyE
			650	50.0	140.0	6000	3.00	480	5.1	2.1 ± 0.8	VDRH14V250xyE
			650	100.0	275.0	10 000	5.00	960	5.5	2.3 ± 0.8	VDRH20X250ByE
275	350	430	745	5.0	20.0	800	0.10	55	4.9	2.0 ± 0.8	VDRH05E275xyE
			710	10.0	40.0	1750	1.00	140	4.9	2.0 ± 0.8	VDRH07K275xyE
			710	25.0	80.0	3500	1.50	270	5.3	2.2 ± 0.8	VDRH10S275xyE
			710	50.0	155.0	6000	3.00	440	5.3	2.2 ± 0.8	VDRH14V275xyE ⁽⁸⁾
			710	100.0	303.0	10 000	5.00	900	5.8	2.5 ± 0.8	VDRH20X275ByE ⁽⁸⁾
300	385	470	810	5.0	21.0	800	0.10	50	5.1	2.2 ± 0.8	VDRH05E300xyE
			775	10.0	42.0	1750	1.00	130	5.1	2.2 ± 0.8	VDRH07K300xyE
			775	25.0	85.0	3500	3.00	240	5.5	2.4 ± 0.8	VDRH10S300xyE
			775	50.0	175.0	6000	3.00	400	5.5	2.4 ± 0.8	VDRH14V300xyE ⁽⁸⁾
			775	100.0	350.0	10 000	5.00	810	5.9	2.7 ± 0.8	VDRH20X300ByE ⁽⁸⁾
320	420	510	880	5.0	22.0	800	0.10	45	5.5	2.4 ± 0.8	VDRH05E320xyE
			842	10.0	45.0	1750	1.00	120	5.5	2.4 ± 0.8	VDRH07K320xyE
			842	25.0	92.0	3500	3.00	220	6.0	2.6 ± 0.8	VDRH10S320xyE
			842	50.0	190.0	6000	3.00	370	6.0	2.6 ± 0.8	VDRH14V320xyE ⁽⁸⁾
			842	100.0	382.0	10 000	5.00	750	6.3	2.9 ± 0.8	VDRH20X320ByE ⁽⁸⁾
350	460	560	940	5.0	25.0	800	0.10	42	5.8	2.7 ± 0.8	VDRH05E350xyE
			920	10.0	51.0	1750	1.00	110	5.8	2.7 ± 0.8	VDRH07K350xyE
			920	25.0	102.0	3500	3.00	200	6.1	2.9 ± 0.8	VDRH10S350xyE
			920	50.0	205.0	6000	3.00	320	6.1	2.9 ± 0.8	VDRH14V350xyE
			920	100.0	410.0	10 000	5.00	650	6.5	3.2 ± 0.8	VDRH20X350ByE
385	505	620	1050	5.0	27.0	800	0.10	40	6.0	3.0 ± 0.8	VDRH05E385xyE
			1025	10.0	54.0	1750	1.00	95	6.0	3.0 ± 0.8	VDRH07K385xyE
			1025	25.0	107.0	3500	3.00	180	6.5	3.2 ± 0.8	VDRH10S385xyE
			1025	50.0	215.0	6000	3.00	280	6.5	3.2 ± 0.8	VDRH14V385xyE
			1025	100.0	420.0	10 000	5.00	570	6.8	3.5 ± 0.8	VDRH20X385ByE



ELECTRICAL DATA AND ORDERING INFORMATION

MAXIMUM CONTINUOUS VOLTAGE	VOLTAGE (3) AT 1 mA	MAXIMUM VOLTAGE AT STATED CURRENT		MAXIMUM ENERGY (4) (10 x 1000 μ s)	MAXIMUM NON-REP. TRANSIENT CURRENT (5) I _{NRP} (8 x 20 μ s)	NOMINAL DISCHARGE CURRENT (7) I _N	TYPICAL CAPACITANCE AT 1 kHz	T (max.)	E	SAP MATERIAL AND ORDERING NUMBER (1) xy (6)	
		V (V)	I (A)								(J)
RMS (2) (V)	DC (V)	(V)									
420	560	680	1150	5.0	28.0	800	0.10	35	6.3	3.2 \pm 0.8	VDRH05E420xyE
			1120	10.0	56.0	1750	1.00	85	6.3	3.2 \pm 0.8	VDRH07K420xyE
			1120	25.0	112.0	3500	3.00	165	6.7	3.4 \pm 0.8	VDRH10S420xyE
			1120	50.0	225.0	6000	3.00	250	6.7	3.4 \pm 0.8	VDRH14V420xyE
			1120	100.0	430.0	10 000	5.00	510	7.1	3.7 \pm 0.8	VDRH20X420ByE
460	615	750	1290	5.0	29.0	800	0.10	30	6.6	3.6 \pm 0.8	VDRH05E460xyE
			1240	10.0	58.0	1750	1.00	75	6.6	3.6 \pm 0.8	VDRH07K460xyE
			1240	25.0	115.0	3500	3.00	150	7.0	3.8 \pm 0.8	VDRH10S460xyE
			1240	50.0	230.0	6000	3.00	225	7.0	3.8 \pm 0.8	VDRH14V460xyE
			1240	100.0	440.0	10 000	5.00	450	7.5	4.1 \pm 0.8	VDRH20X460ByE
485	640	780	1290	10.0	59.0	1750	1.00	65	6.8	3.7 \pm 0.8	VDRH07K485xyE
			1290	25.0	116.0	3500	3.00	145	7.3	3.9 \pm 0.8	VDRH10S485xyE
			1290	50.0	233.0	6000	3.00	220	7.3	3.9 \pm 0.8	VDRH14V485xyE
			1290	100.0	450.0	10 000	5.00	400	7.6	4.2 \pm 0.8	VDRH20X485ByE
510	670	820	1355	10.0	60.0	1750	1.00	62	7.0	3.9 \pm 0.8	VDRH07K510xyE
			1355	25.0	118.0	3500	3.00	135	7.5	4.1 \pm 0.8	VDRH10S510xyE
			1355	50.0	235.0	6000	3.00	220	7.5	4.1 \pm 0.8	VDRH14V510xyE
			1355	100.0	460.0	10 000	5.00	400	7.9	4.4 \pm 0.8	VDRH20X510ByE
550	745	910	1500	25.0	127.0	3500	3.00	120	7.9	4.5 \pm 0.8	VDRH10S550xyE
			1500	50.0	255.0	6000	3.00	180	7.9	4.5 \pm 0.8	VDRH14V550xyE
			1500	100.0	510.0	10 000	5.00	320	8.3	4.9 \pm 0.8	VDRH20X550ByE
625	825	1000	1650	25.0	140.0	3500	1.50	105	8.4	5.0 \pm 0.8	VDRH10S625ByE
			1650	50.0	283.0	6000	3.00	165	8.4	5.0 \pm 0.8	VDRH14V625ByE
			1650	100.0	566.0	10 000	5.00	280	8.8	5.3 \pm 0.8	VDRH20X625ByE
680	895	1100	1815	25.0	155.0	3500	1.50	80	9.8	5.4 \pm 0.8	VDRH10S680ByE
			1815	50.0	310.0	6000	3.00	150	9.8	5.4 \pm 0.8	VDRH14V680ByE
			1815	100.0	620.0	10 000	3.00	250	10.2	5.8 \pm 0.8	VDRH20X680ByE

Notes

- (1) The products are certified according to cULus (E332800) for operation up to 85 °C or 105 °C, and VDE/IEC (40013495) for operation up to 85 °C. See Agency Approval section for certificate download
- (2) The sinusoidal voltage is assumed as the normal operating condition. If a non-sinusoidal voltage is present, type selection should be based on multiplying the peak voltage by a factor of 0.707
- (3) The voltage measured at 1 mA meets the requirements of IEC 61051. The tolerance on the voltage at 1 mA is \pm 10 %
- (4) High energy surges are generally of longer duration. The maximum energy for one pulse of 10 x 1000 μ s is given as a reference for longer duration pulses. This pulse can be characterized by peak current (I_p) and pulse width t₂ (virtual time of half I_p value, following "IEC 60060-2, section 6"). If V_p is the clamping voltage corresponding to I_p, the energy absorbed in the varistor is determined by the formula:
 $E = K \times V_p \times I_p \times t_2$ where K is dependent on the value of t₂ (see Peak Current as a Function of Pulse Width drawing)
- (5) A current wave of 8 x 20 μ s is used as a standard for pulse current and clamping voltage ratings. The maximum non-repetitive transient current is given for one pulse applied during the life of the component
- (6) For composition of the SAP part number:
 Replace "x" by B for bulk type Replace "y" by S for straight leads
 T for tape and reel K for kinked leads (bulk only)
 A for tape and ammpack L for kinked leads with H0 = 16 mm (tape and reel/ammo)
 M for kinked leads with H0 = 18.25 mm (tape and reel/ammo)
- (7) All varistors are UL 1449 edition 4 recognized as SPD type 5 (component level) for operating temperatures up to 85 °C. The varistors may be used in other SPD types as 2, 3, or 4 depending on the indicated I_N nominal discharge current ratings. The final acceptance of the component is dependent upon its installation and use in complete equipment submitted to underwriters laboratories Inc.
- (8) These varistors are UL 1449 edition 4 recognized as SPD type 5 (component level) for operating temperatures up to 105 °C



ELECTRICAL CHARACTERISTICS

ELECTRICAL DATA		
PARAMETER	VALUE	UNIT
Maximum continuous voltage:		
RMS	11 to 680	V
DC	14 to 895	V
Maximum non-repetitive transient current (I_{NRP}) (8 x 20 μ s)		
VDRH05	250 or 800	A
VDRH07	500 or 1750	A
VDRH10	1000 or 3500	A
VDRH14	2000 or 6000	A
VDRH20	3000 or 10 000	A
Thermal resistance:		
VDRH05	\approx 80	K/W
VDRH07	\approx 70	K/W
VDRH10	\approx 60	K/W
VDRH14	\approx 50	K/W
VDRH20	\approx 40	K/W
Maximum dissipation:		
VDRH05	100	mW
VDRH07	250	mW
VDRH10	400	mW
VDRH14	600	mW
VDRH20	1000	mW
Temperature coefficient of voltage at 1 mA maximum	\pm 0.05	%/K
Voltage proof between interconnected leads and case	2500	V
Storage temperature	-40 to +150	$^{\circ}$ C
Operating temperature	-40 to +125	$^{\circ}$ C

DERATING CURVE

Maximum Voltage
Maximum Dissipation
Maximum Energy
Maximum Transient Current

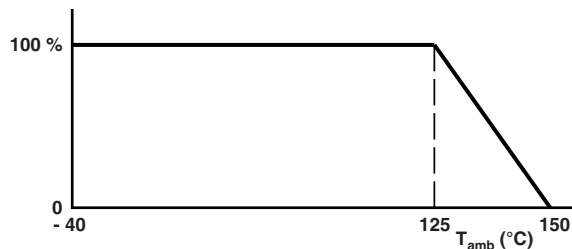

PEAK CURRENT AS A FUNCTION OF PULSE WIDTH

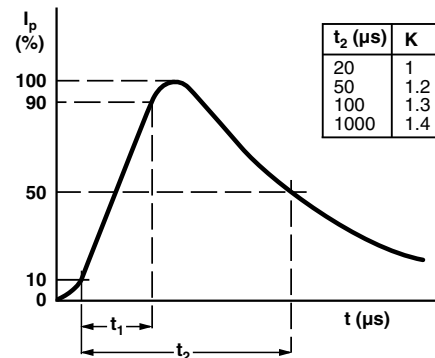

COMPONENT DIMENSIONS (BULK TYPE) in millimeters AND CATALOG NUMBERS

D MAX.		A MAX.		A ₀ MAX.		L MIN.	T ⁽¹⁾ MAX.	E ⁽¹⁾	d	F	CATALOG NUMBER
V \leq 320 V	V > 320 V	V \leq 300 V	V > 300 V	V \leq 320 V	V > 320 V						
7.0		9.0		11.0		24.0	6.5	0.7 to 3.6	0.6 \pm 0.05	5 \pm 1.0	VDRH05
9.0		11.0		13.0		24.0	6.5	0.7 to 3.6	0.6 \pm 0.05	5 \pm 1.0	VDRH07
12.0	12.5	14.5	15.0	16.5	17.0	17.0	8.0	0.9 to 4.5	0.8 \pm 0.05	7.5 \pm 1.0	VDRH10
16.0	16.5	19.0		21.0	21.5	16.0	8.0	0.9 to 4.5	0.8 \pm 0.05	7.5 \pm 1.0	VDRH14
22.5	23.0	25.5		27.5	28.0	24.0	10.0	1.1 to 5.8	1.0 \pm 0.05	10 \pm 1.0	VDRH20

Note

⁽¹⁾ T_{max} . and E values per size and voltage level can be found back in the Electrical Data and Ordering Information table

VARISTORS IN BULK					
TYPE	VDRH05.... Ø 5 mm 11 V to 460 V	VDRH07.... Ø 7 mm 11 V to 510 V	VDRH10.... Ø 10 mm 11 V to 680 V	VDRH14.... Ø 14 mm 11 V to 680 V	VDRH20.... Ø 20 mm 11 V to 680 V
Straight leads; see outline of components with straight leads drawing	BSE	BSE	BSE	BSE	BSE
Kinked leads; see outline of components with kinked leads drawing	BKE	BKE	BKE	BKE	BKE
Packaging quantities					
11 V to 95 V	250	250	250	100	50
130 V to 385 V	250	250	250	100	50
420 V to 460 V	250	250	200	100	50
485 V to max. V	-	250	150	100	50

DIMENSIONS in millimeters: see Component Dimensions and Electrical Data table

OUTLINE of Component with Straight Leads

OUTLINE of Component with Kinked Leads

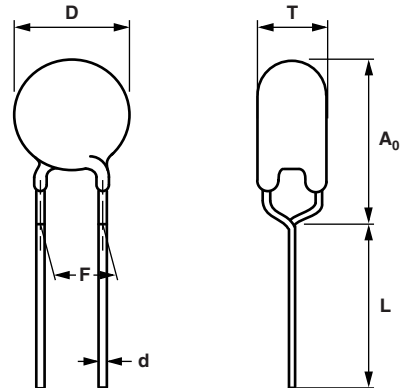
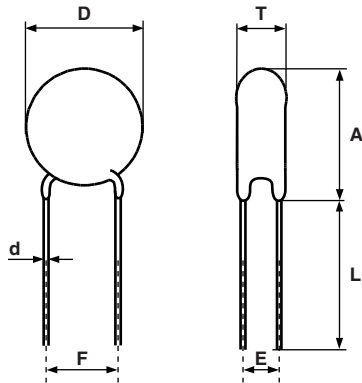

VARISTORS ON TAPE IN AMMOPACK				
TYPE	VDRH05.... Ø 5 mm 11 V to 460 V	VDRH07.... Ø 7 mm 11 V to 510 V	VDRH10.... Ø 10 mm 11 V to 680 V	VDRH14.... Ø 14 mm 11 V to 680 V
Straight leads H = 18 mm H = 20 mm See drawing: taped version with straight leads	-	-	ASE	ASE
Kinked leads H ₀ = 18.25 mm H ₀ = 16 mm See drawing: taped version with kinked leads	AME	AME	AME	AME
	ALE	ALE	ALE	ALE
Packaging quantities				
14 V to 210 V	1500 ⁽¹⁾	1500 ⁽¹⁾	500	500
230 V to 510 V	1000	1000	500	500
550 V to max. V	-	-	400	400

Note

⁽¹⁾ Except for 35 V and 40 V = 1000 pieces

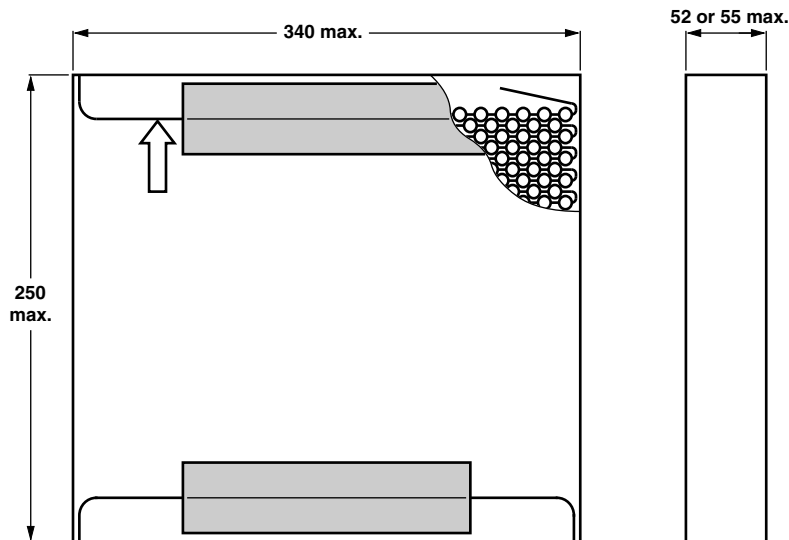
DIMENSIONS OF AMMOPACK in millimeters

VARISTORS ON TAPE AND REEL				
TYPE	VDRH05.... Ø 5 mm 11 V to 460 V	VDRH07.... Ø 7 mm 11 V to 510 V	VDRH10.... Ø 10 mm 11 V to 680 V	VDRH14.... Ø 14 mm 11 V to 680 V
H = 18 mm H = 20 mm See drawing: taped version with straight leads	Straight leads -	-	TSE	TSE
Kinked leads H ₀ = 18.25 mm H ₀ = 16 mm See drawing: taped version with kinked leads	TME TLE	TME TLE	TME TLE	TME TLE
Packaging quantities				
14 V to 250 V	1500	1500	1000	750
275 V to 300 V	1500	1500	750	750
320 V to 350 V	1000	1000	500	500
385 V to max. V	1000	1000	500	500

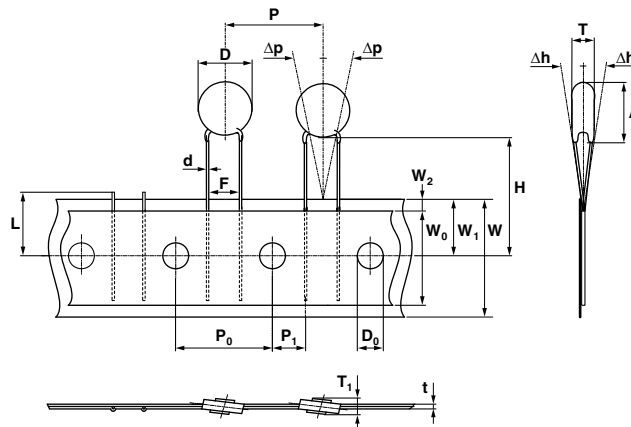
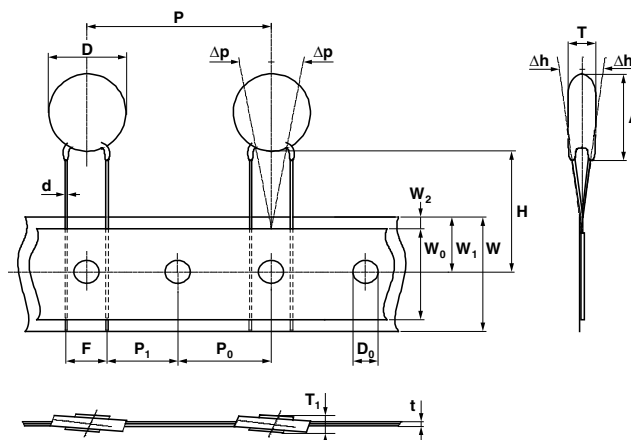
PACKAGING
TAPED VERSION WITH STRAIGHT LEADS (only for VDRH05 and VDRH07)

TAPED VERSION WITH STRAIGHT LEADS (only for VDRH10 and VDRH14)

TAPED VERSION WITH KINKED LEADS

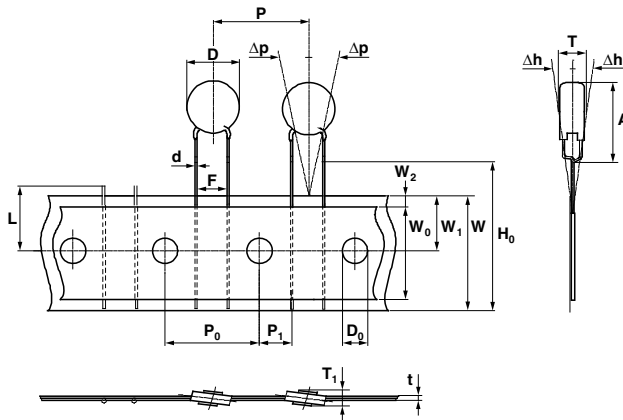
(only for VDRH05 and VDRH07)

TAPED VERSION WITH KINKED LEADS

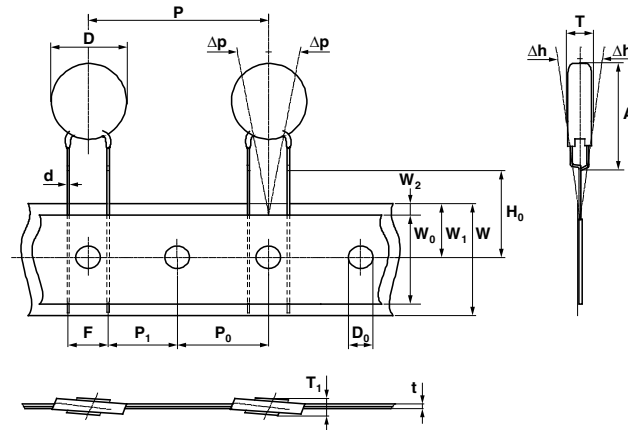
(only for VDRH10 and VDRH14)



TAPING DATA (based on IEC 60286-2)						
SYMBOL	PARAMETER		DIMENSIONS/TOLERANCE			
			VDRH05	VDRH07	VDRH10	VDRH14
A max.	Max. mounting height	$V \leq 300 \text{ V}$	9.0	11.0	14.5	19.0
		$V > 300 \text{ V}$			15.0	
A_0 max.	Max. mounting height	$V \leq 320 \text{ V}$	11.0	13.0	16.5	21.0
		$V > 320 \text{ V}$			17.0	21.5
D max.	Max. body diameter	$V \leq 320 \text{ V}$	7.0	9.0	12.0	16.0
		$V > 320 \text{ V}$			12.5	16.5
d	Lead wire diameter		0.6 ± 0.05		0.8 ± 0.05	
F	Lead to lead distance ⁽¹⁾		5.0 + 0.8/- 0.2		7.5 ± 0.8	
H	Distance component to tape center ⁽²⁾		20.0 + 2.0/- 0.0		18.0 + 2.0/- 0.0	
H_0	Lead wire clinch height		16.0 or 18.25 ± 0.5			
P	Pitch of components on tape		12.7 ± 1.0		25.4 ± 1.0	
T	Total thickness		See Electrical Data table			

Notes

- (1) Guaranteed between component and tape
 (2) For VDRH14V510xSE and VDRH14V550xSE: H = 20 mm ± 1 mm



V/I CHARACTERISTICS

11 V_{RMS} to 40 V_{RMS}; VDRH05

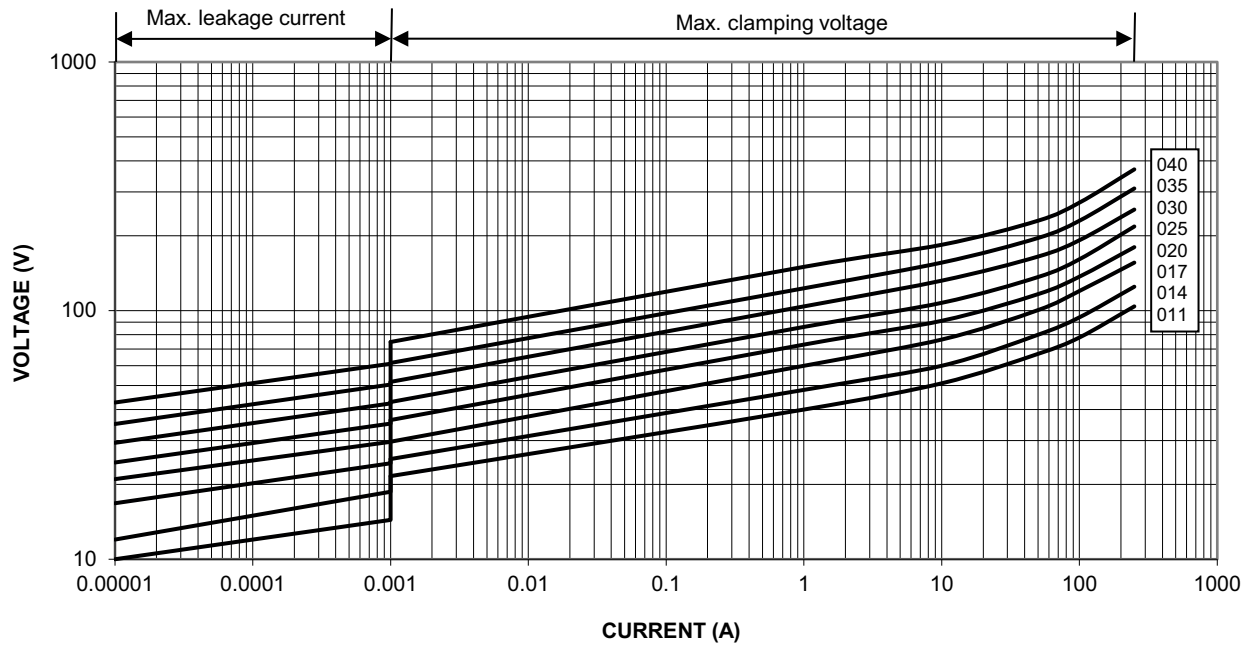

50 V_{RMS} to 195 V_{RMS}; VDRH05

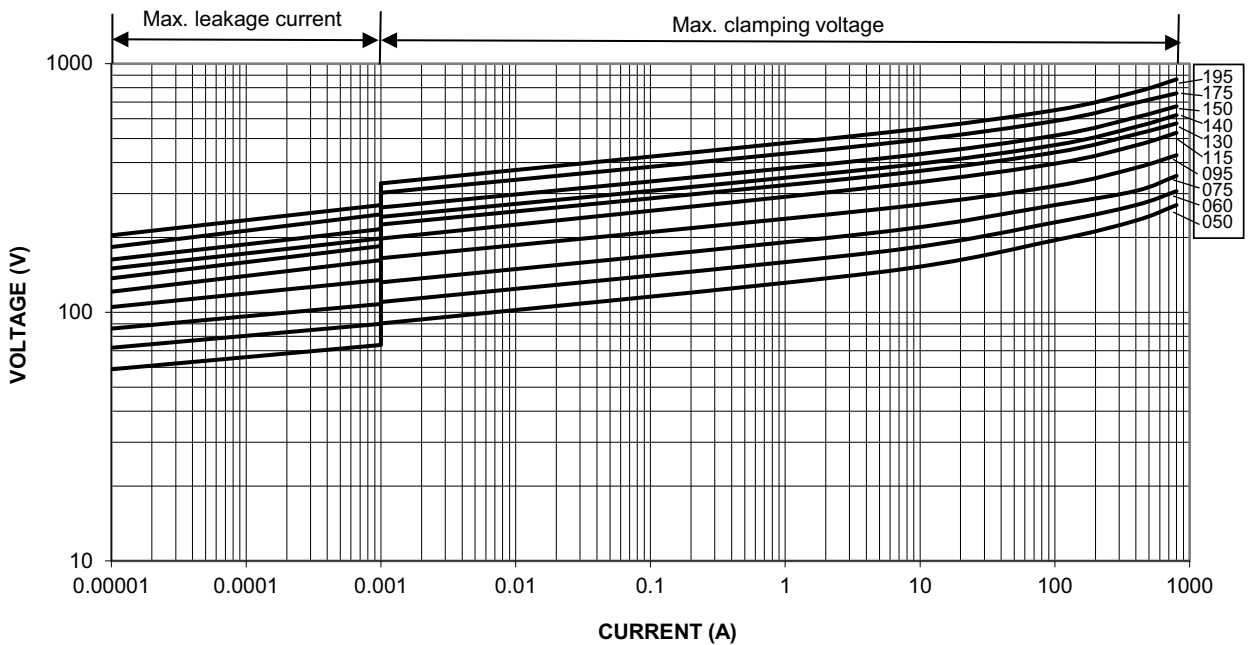



210 V_{RMS} to 460 V_{RMS}; VDRH05

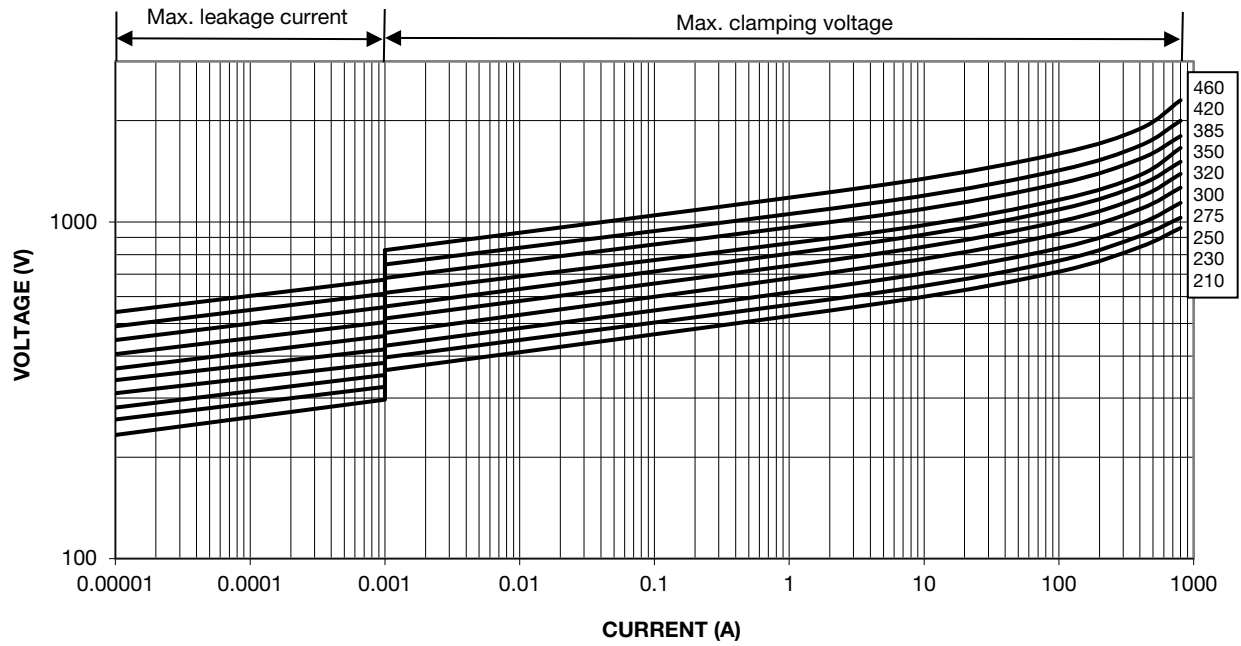

11 V_{RMS} to 40 V_{RMS}; VDRH07

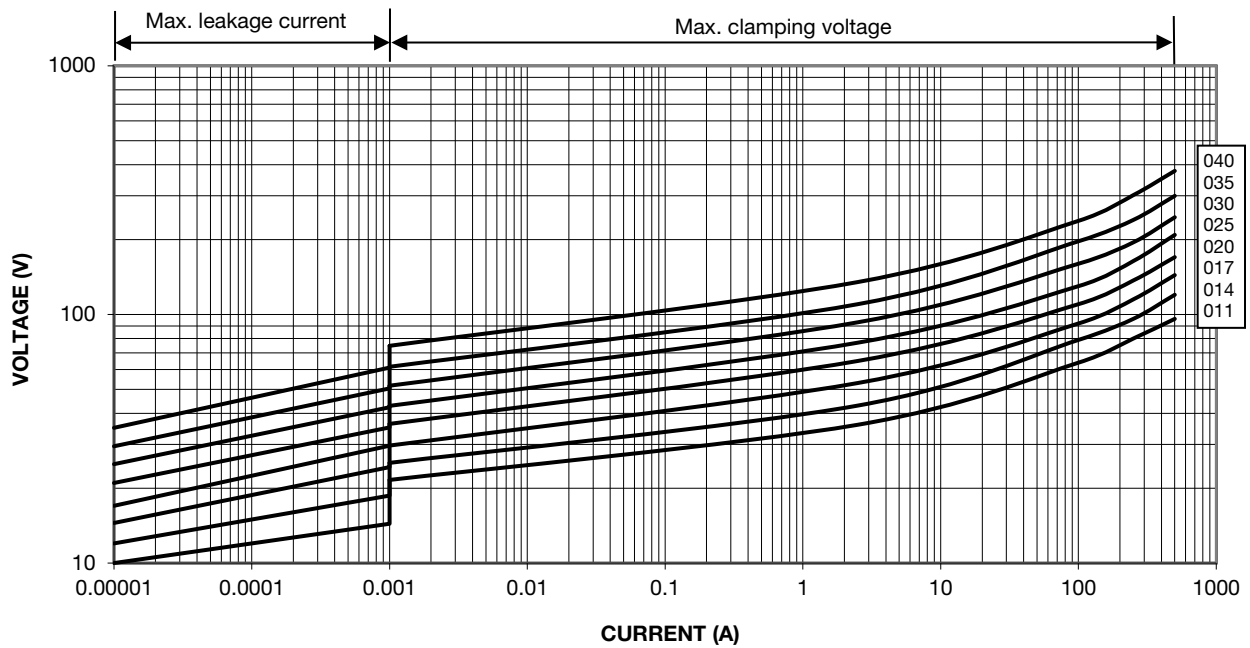



50 V_{RMS} to 210 V_{RMS}; VDRH07

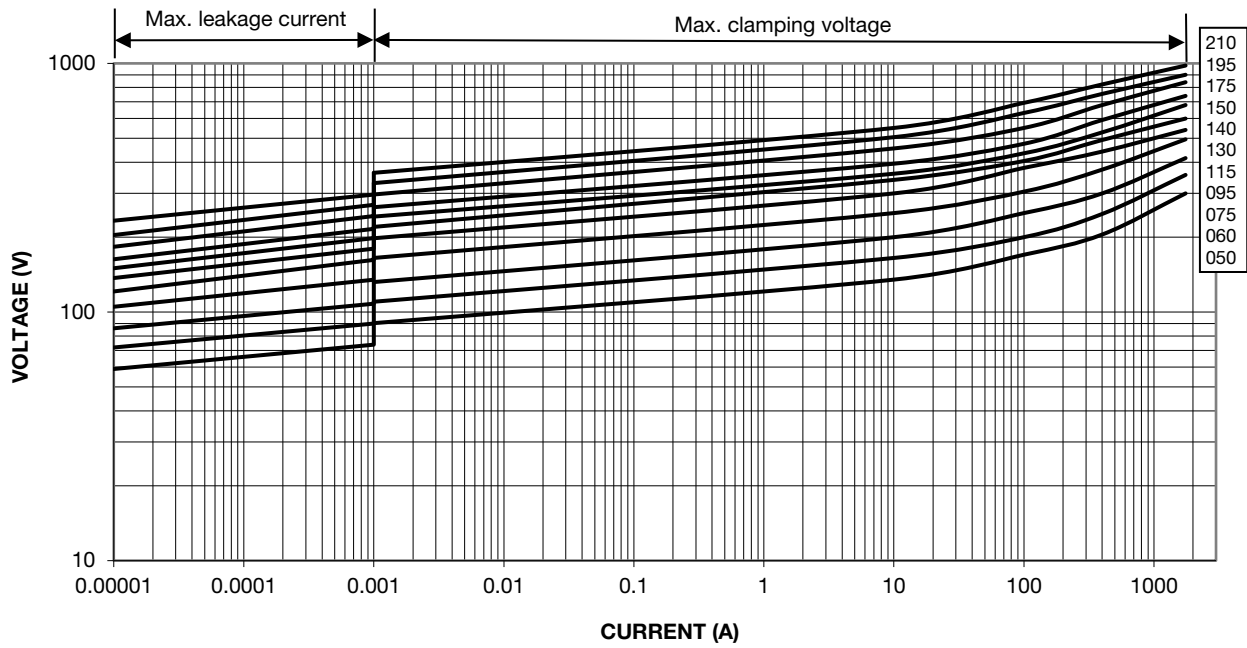

230 V_{RMS} to 510 V_{RMS}; VDRH07

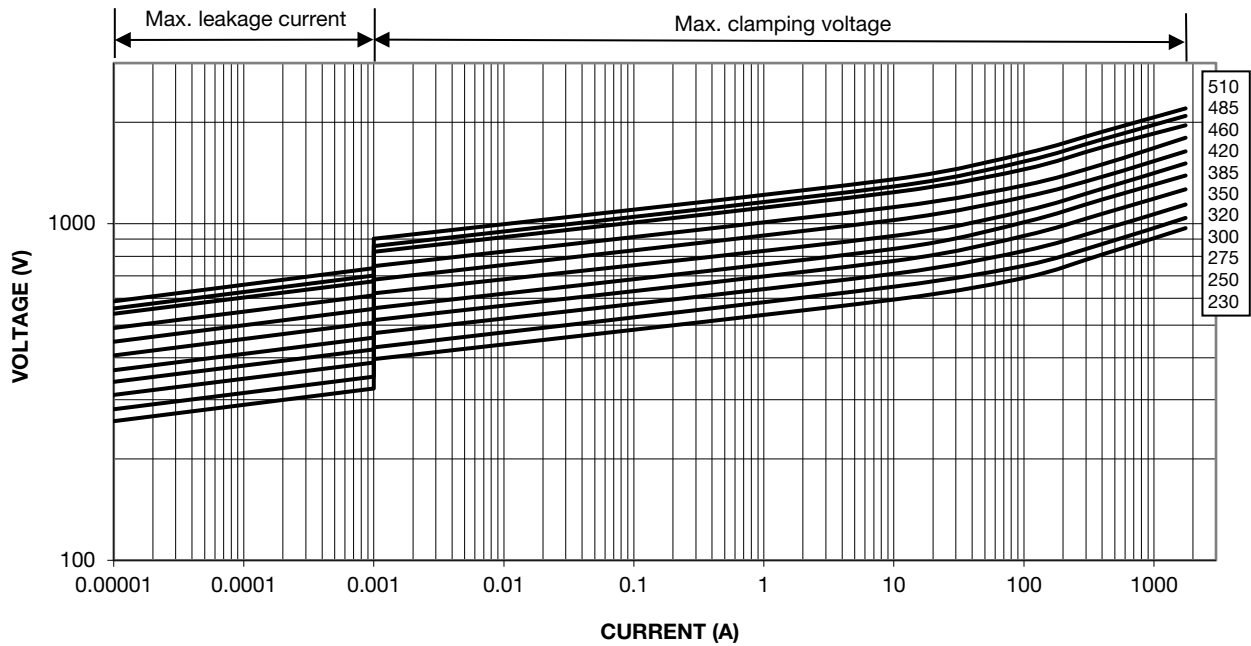



11 V_{RMS} to 40 V_{RMS}; VDRH10

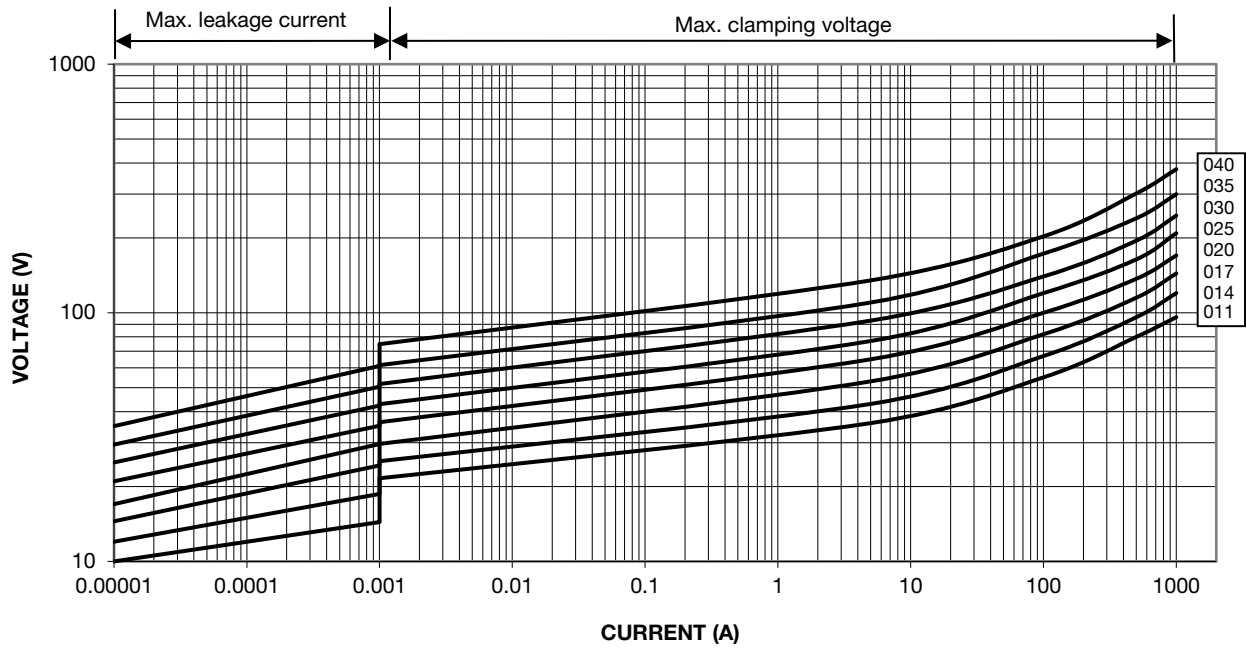

50 V_{RMS} to 210 V_{RMS}; VDRH10

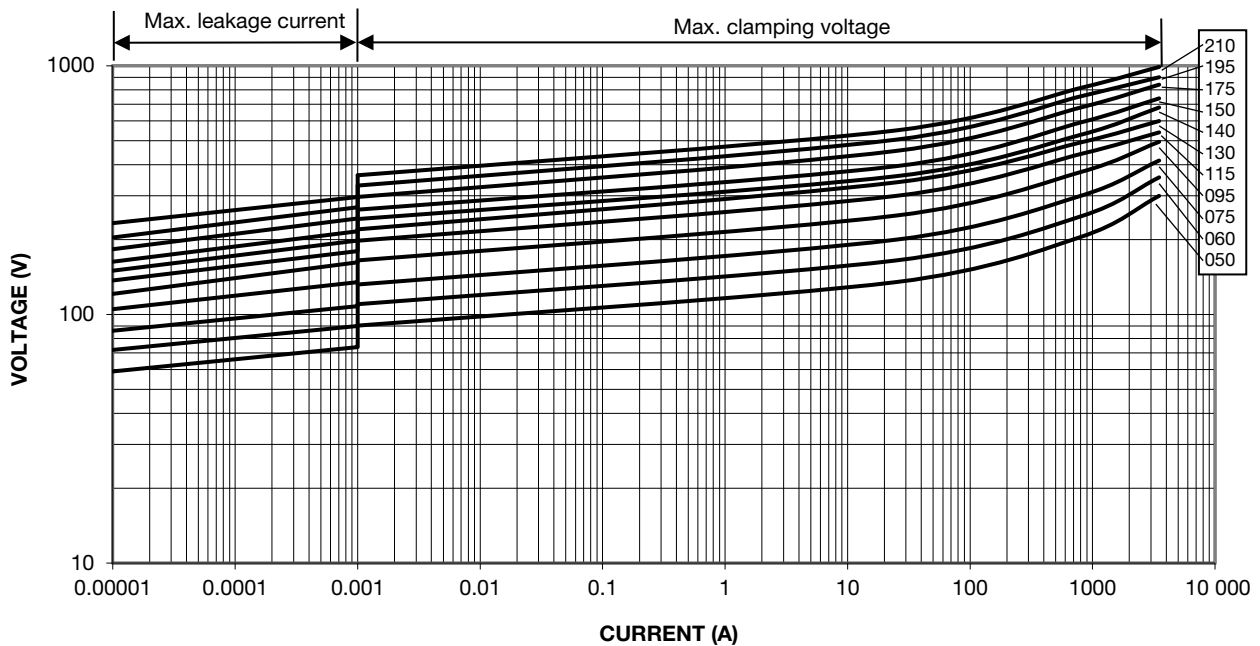



230 V_{RMS} to 680 V_{RMS}; VDRH10

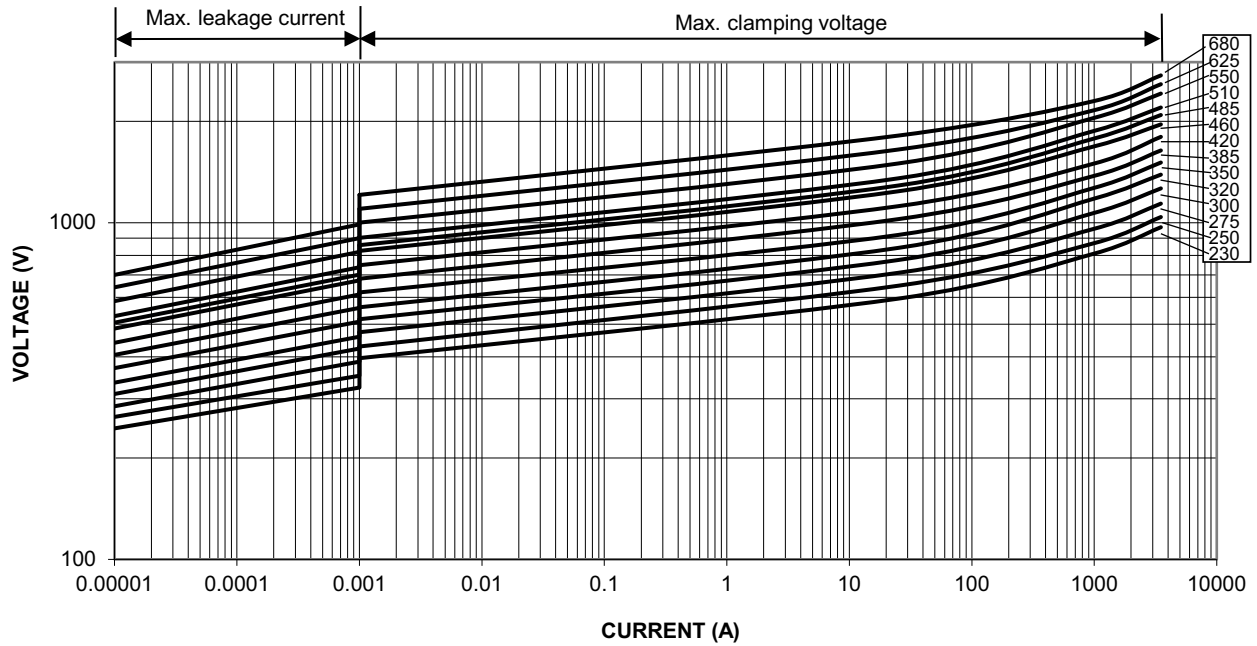

11 V_{RMS} to 40 V_{RMS}; VDRH14

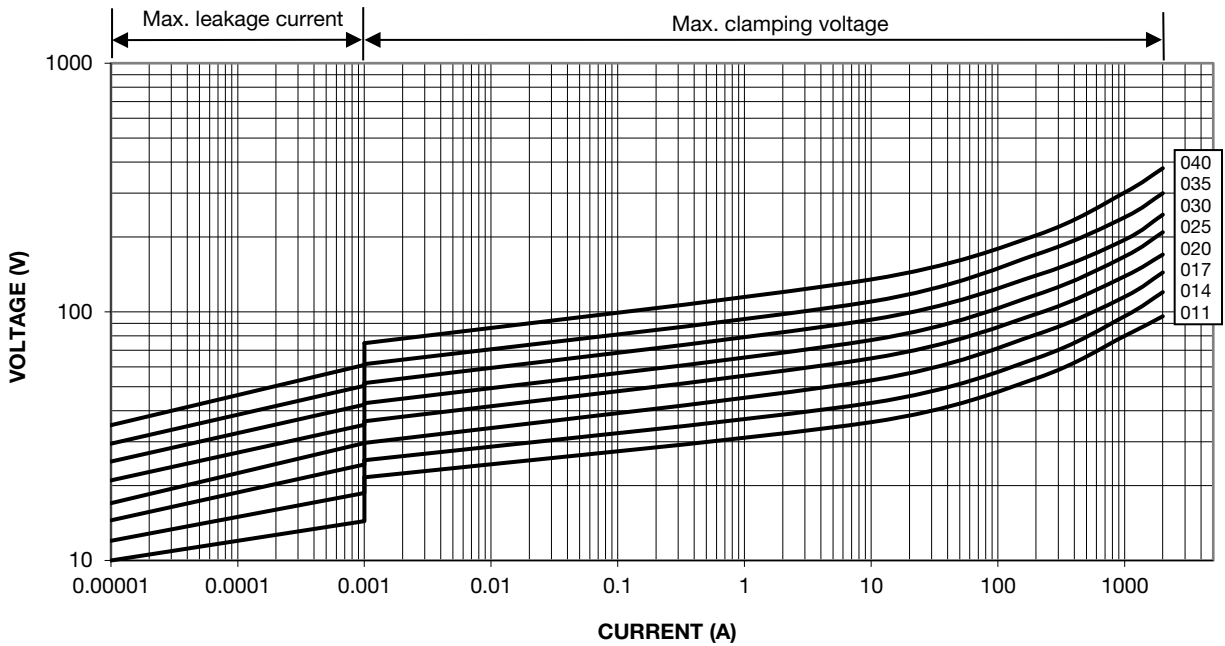



50 V_{RMS} to 210 V_{RMS}; VDRH14

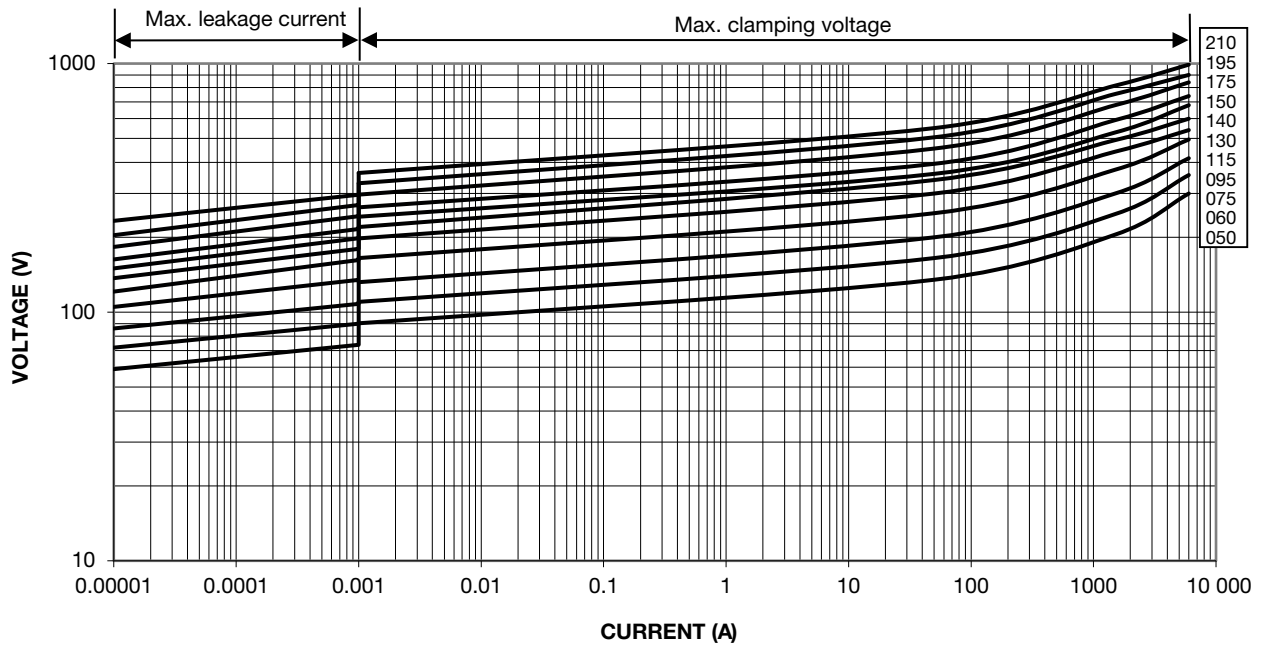

230 V_{RMS} to 680 V_{RMS}; VDRH14

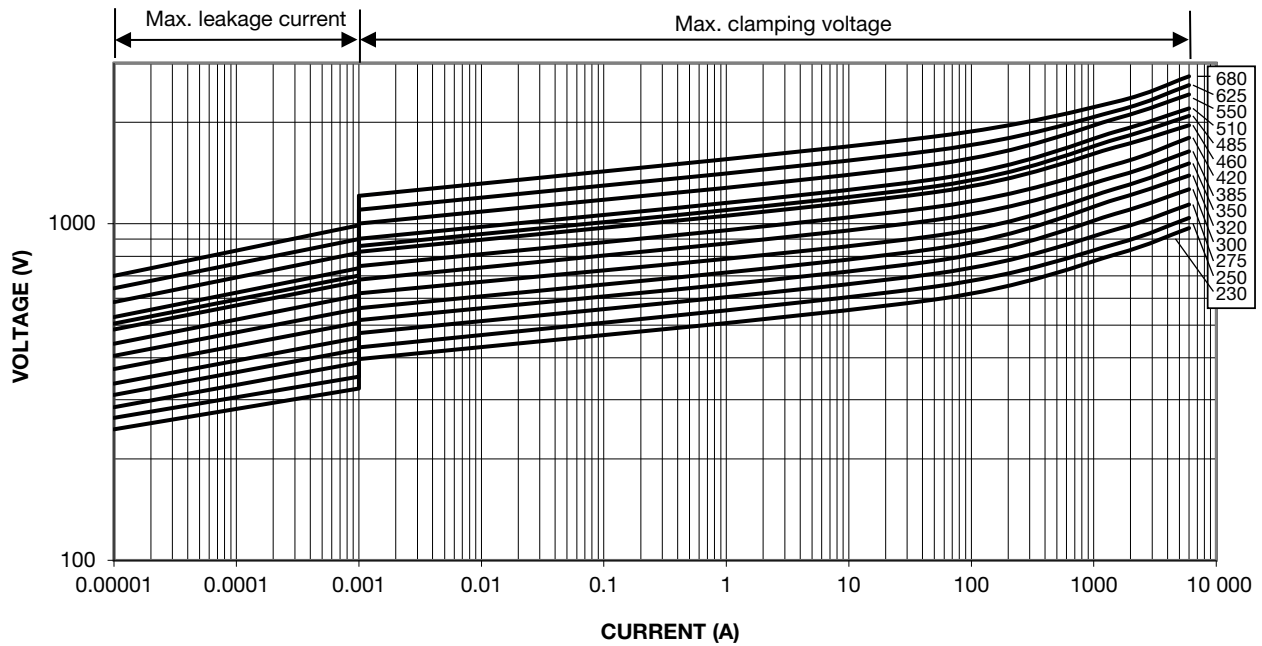



14 V_{RMS} to 40 V_{RMS}; VDRH20

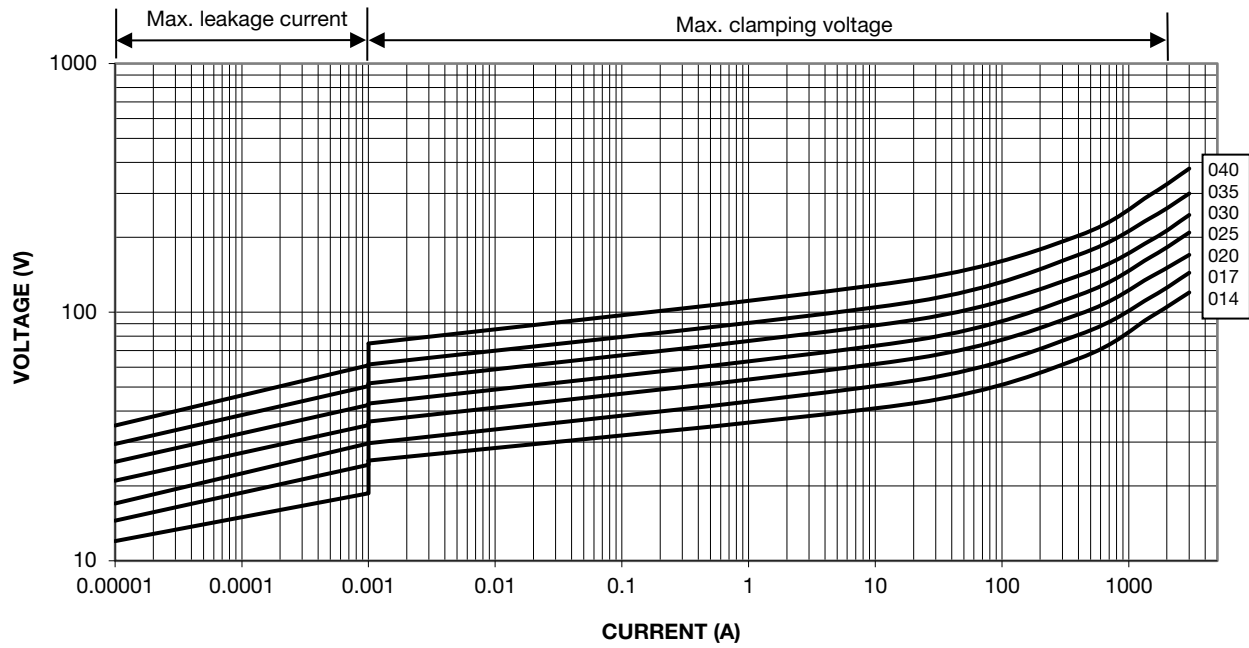

60 V_{RMS} to 210 V_{RMS}; VDRH20

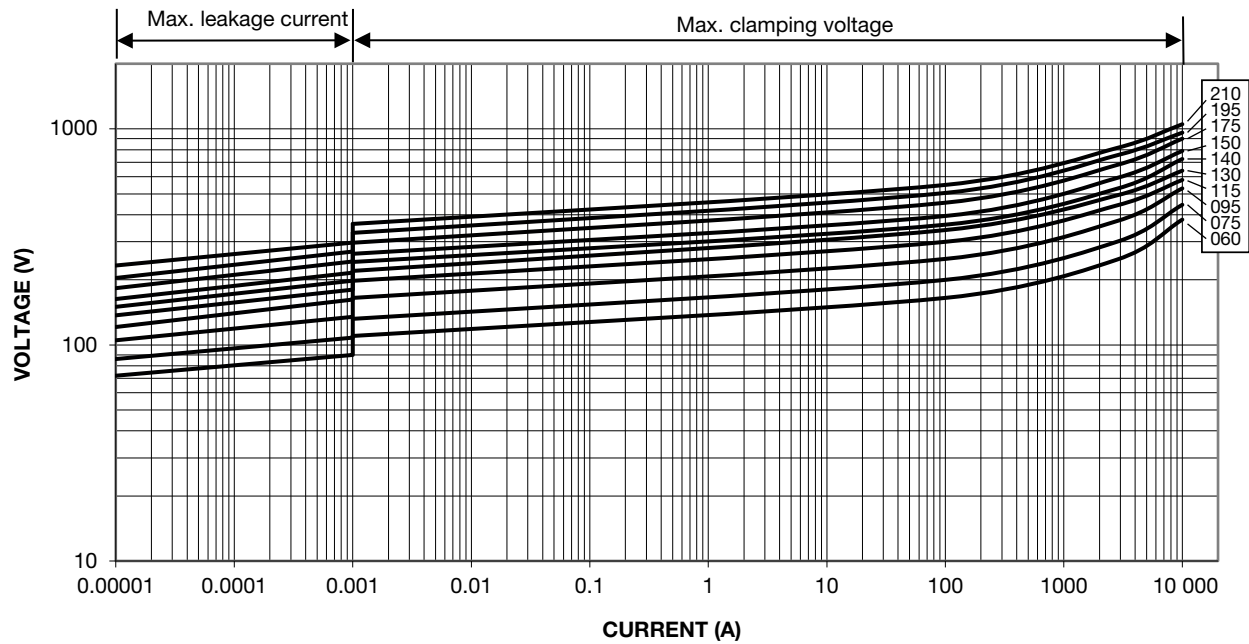



230 V_{RMS} to 680 V_{RMS}; VDRH20

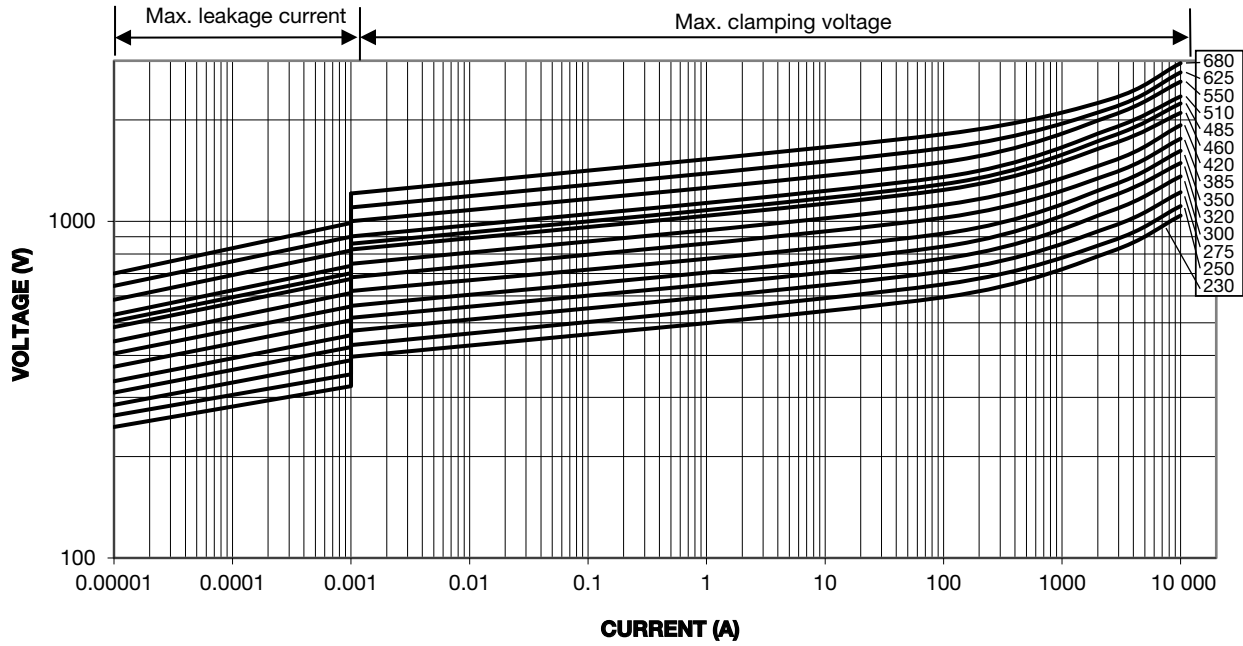

MAXIMUM APPLICABLE TRANSIENT CURRENT AS A FUNCTION OF PULSE DURATION

11 V_{RMS} to 40 V_{RMS}; VDRH05

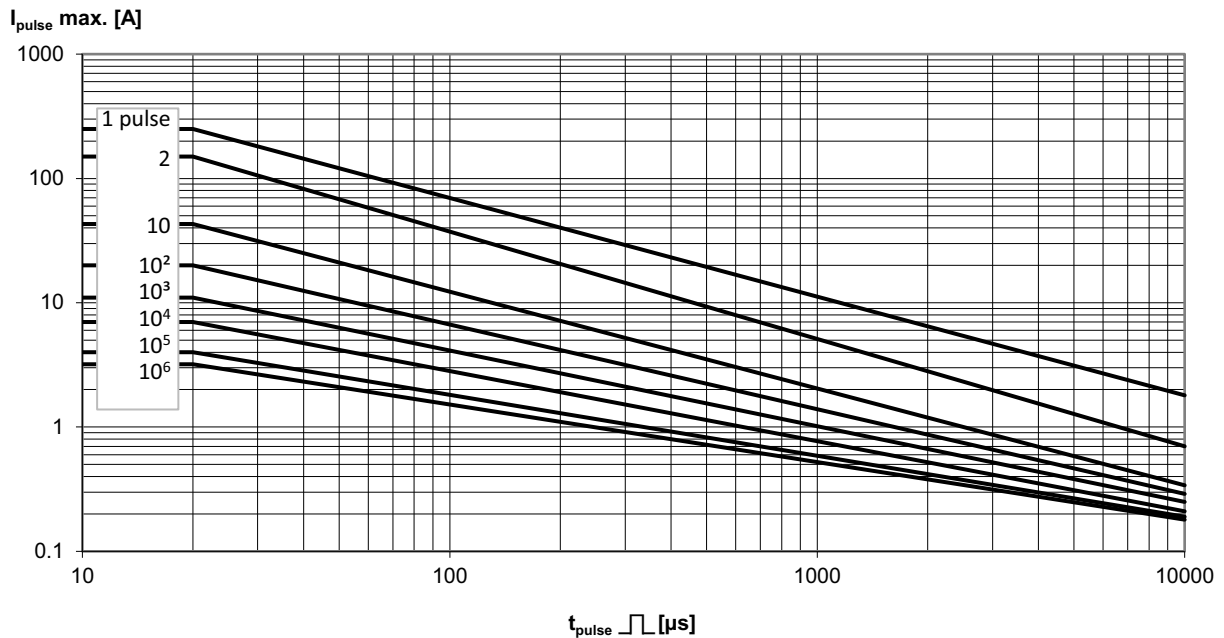



50 V_{RMS} to 460 V_{RMS}; VDRH05

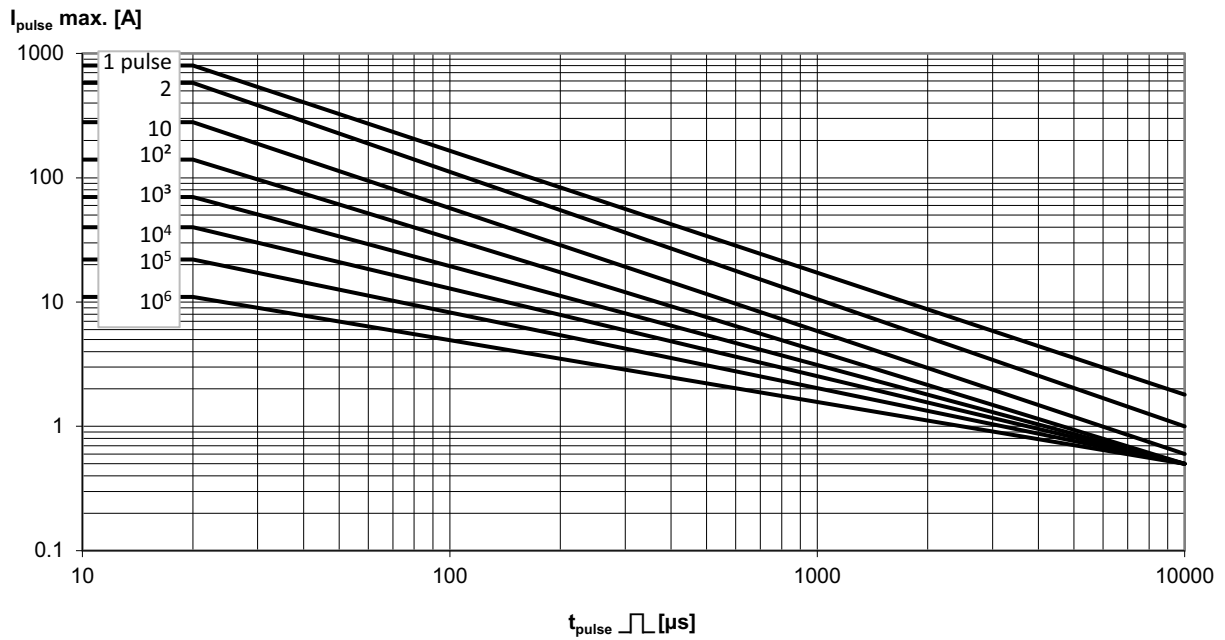

11 V_{RMS} to 40 V_{RMS}; VDRH07

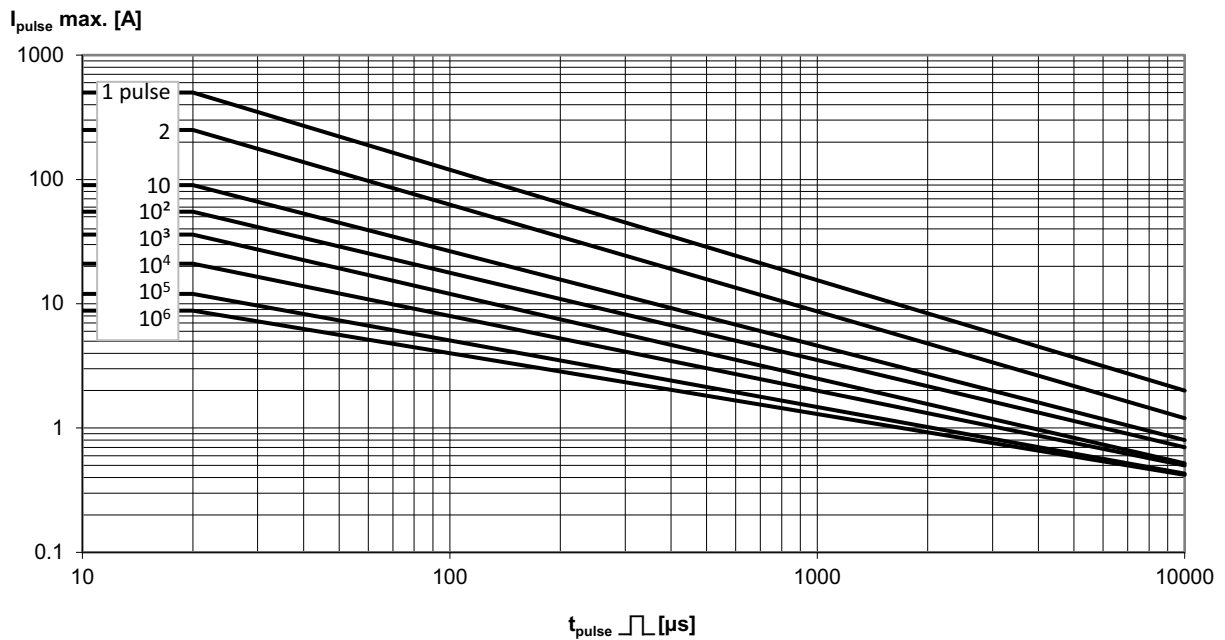



50 V_{RMS} to 510 V_{RMS}; VDRH07

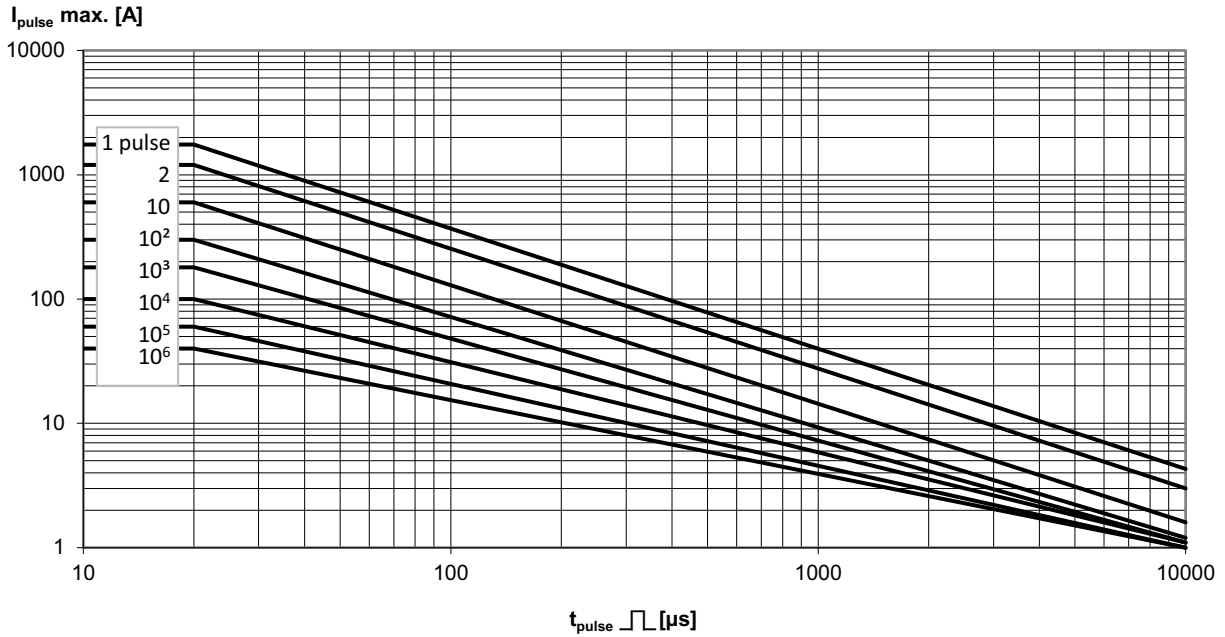

11 V_{RMS} to 40 V_{RMS}; VDRH10

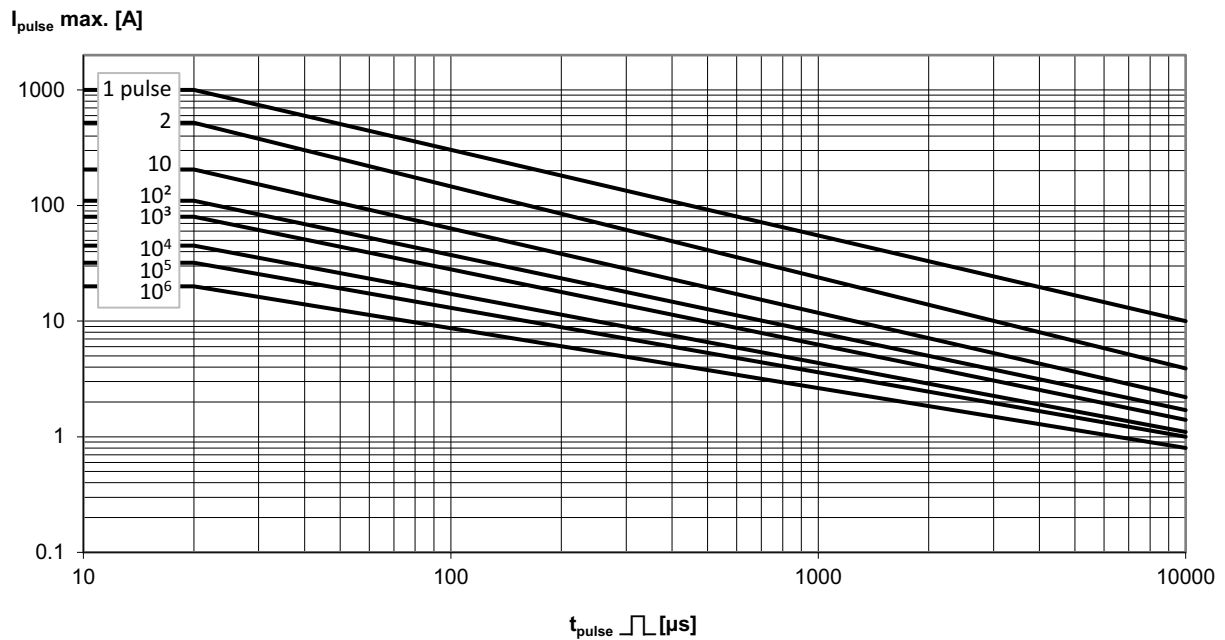



50 V_{RMS} to 300 V_{RMS}; VDRH10

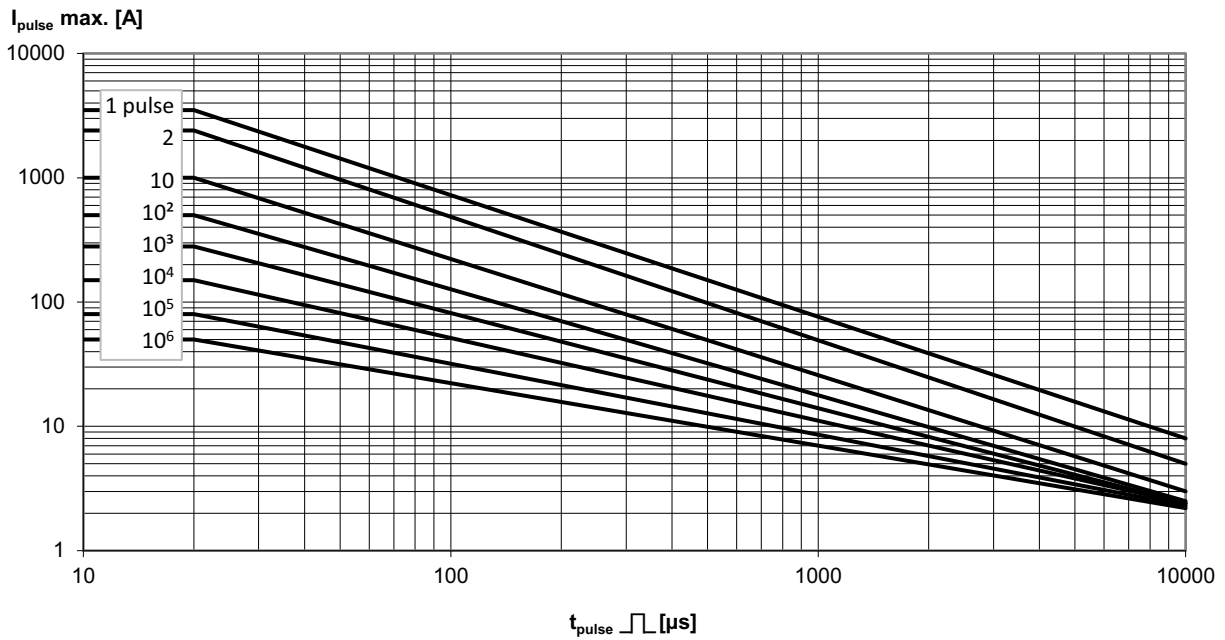

320 V_{RMS} to 680 V_{RMS}; VDRH10

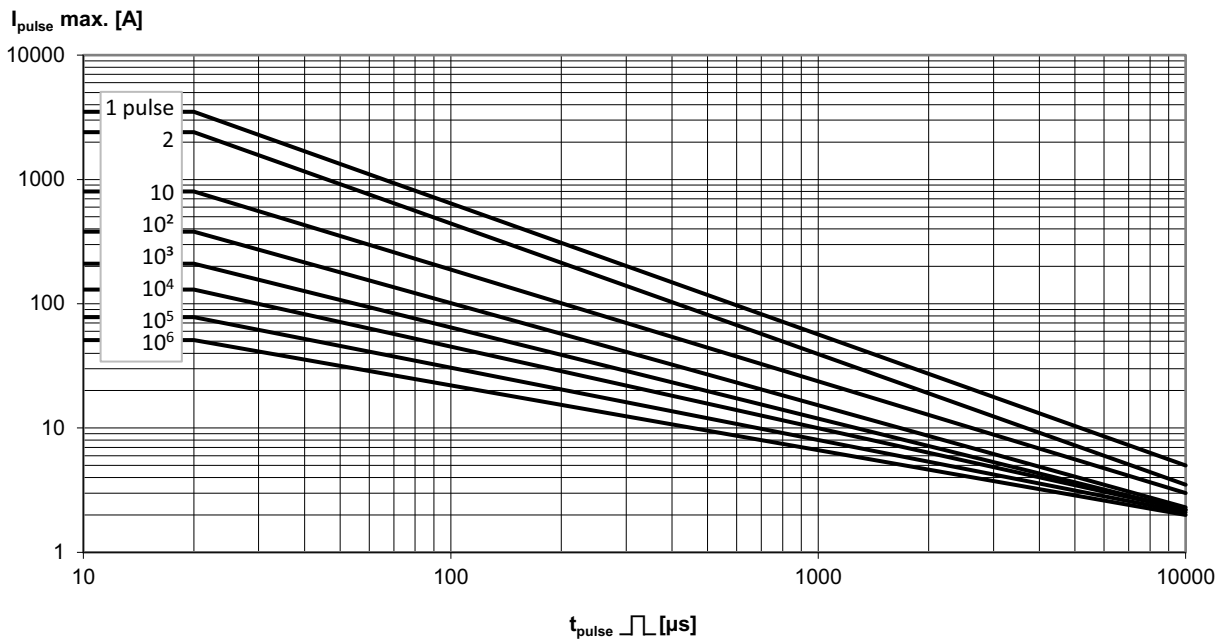



11 V_{RMS} to 40 V_{RMS}; VDRH14

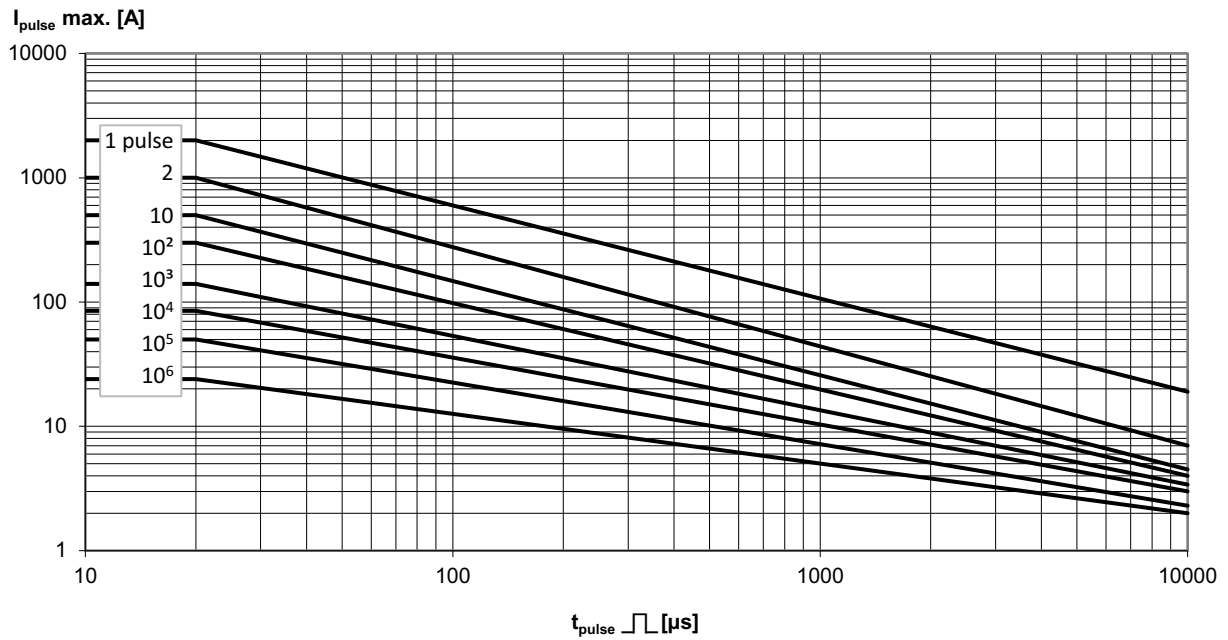

50 V_{RMS} to 300 V_{RMS}; VDRH14

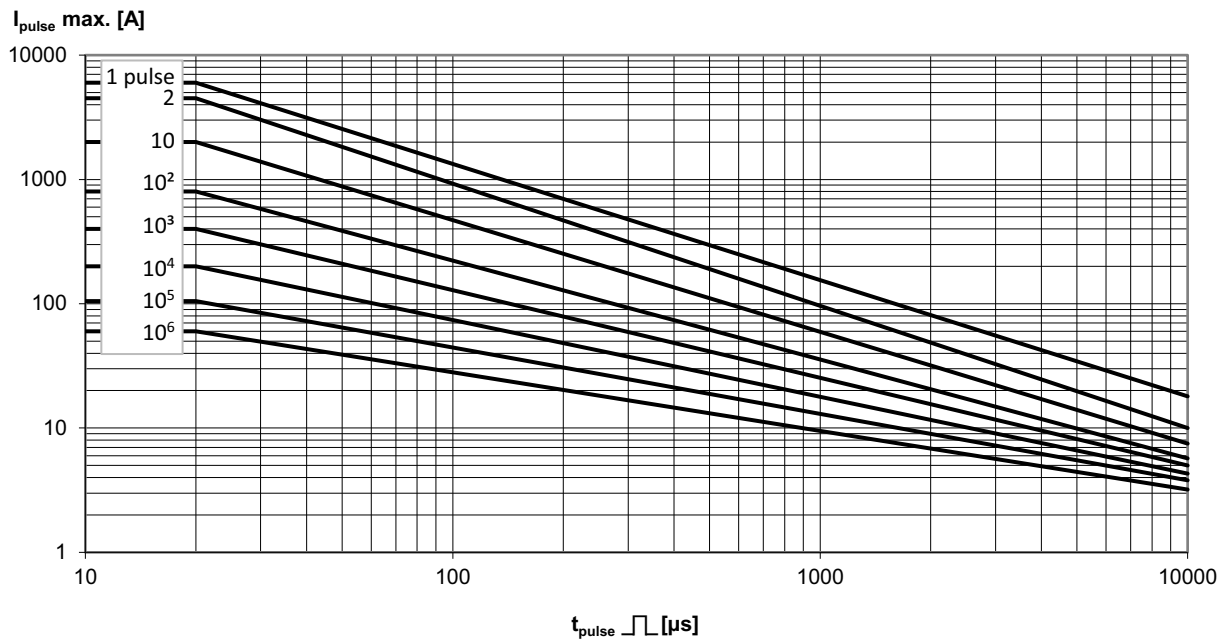



320 V_{RMS} to 680 V_{RMS}; VDRH14

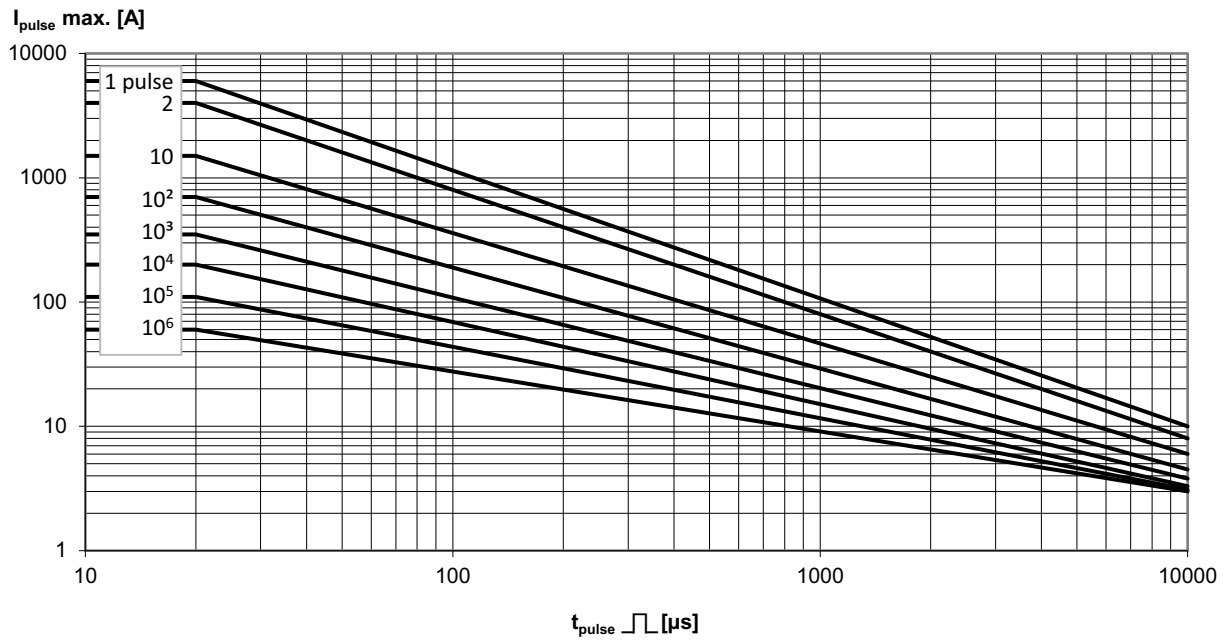

14 V_{RMS} to 40 V_{RMS}; VDRH20

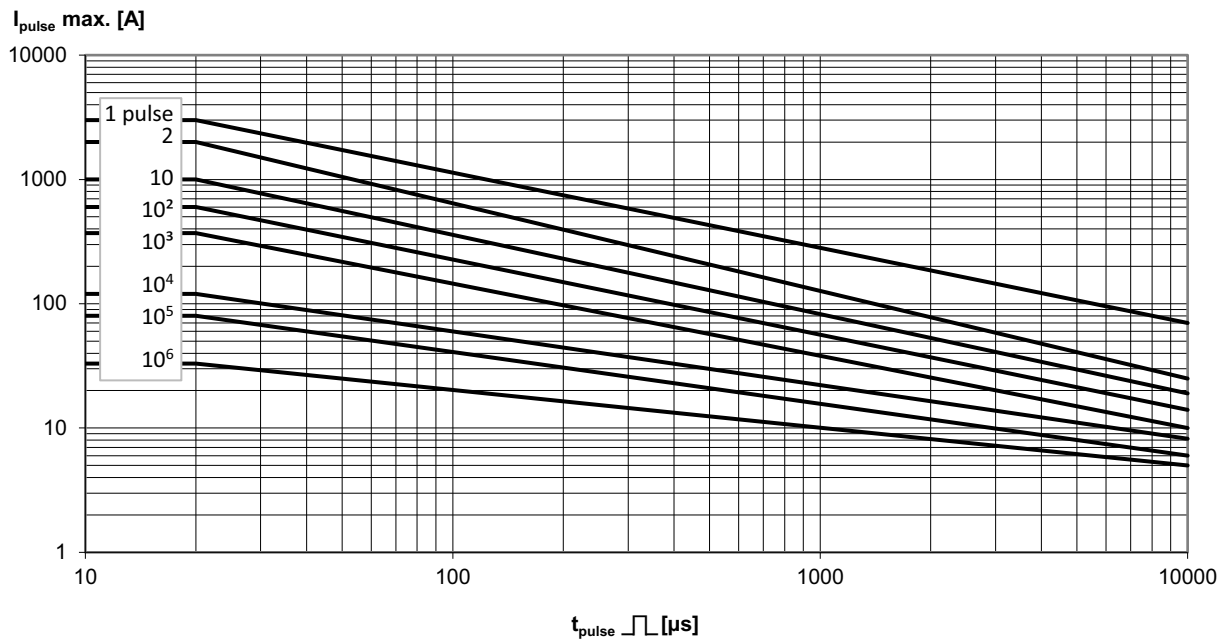



60 V_{RMS} to 300 V_{RMS}; VDRH20

$I_{\text{pulse max. [A]}}$

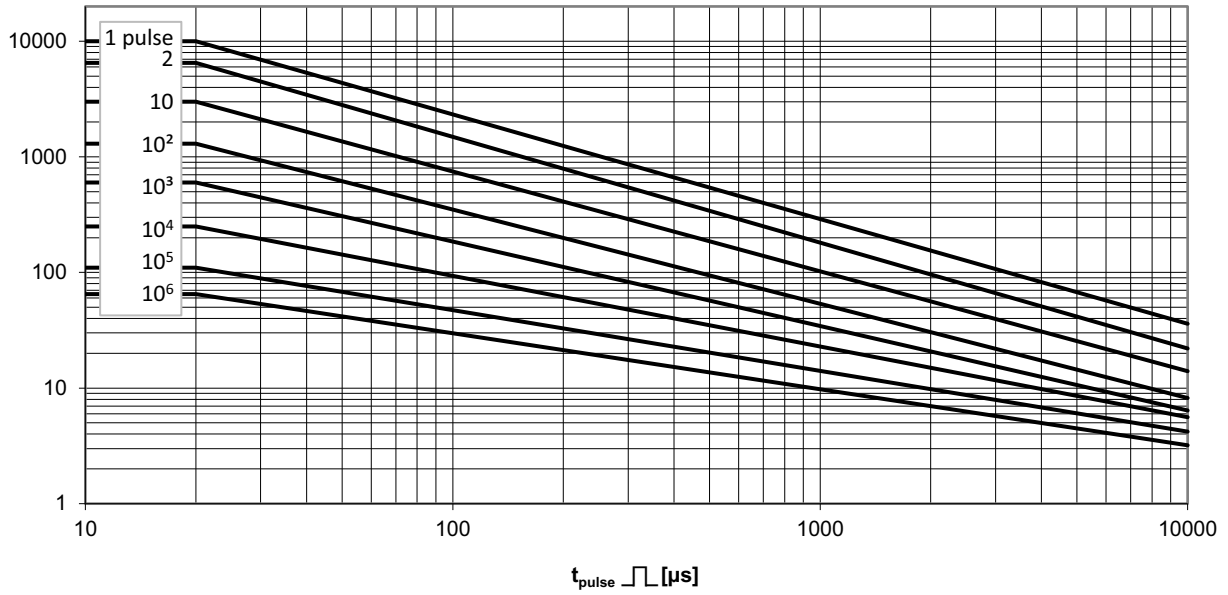

320 V_{RMS} to 680 V_{RMS}; VDRH20

$I_{\text{pulse max. [A]}}$

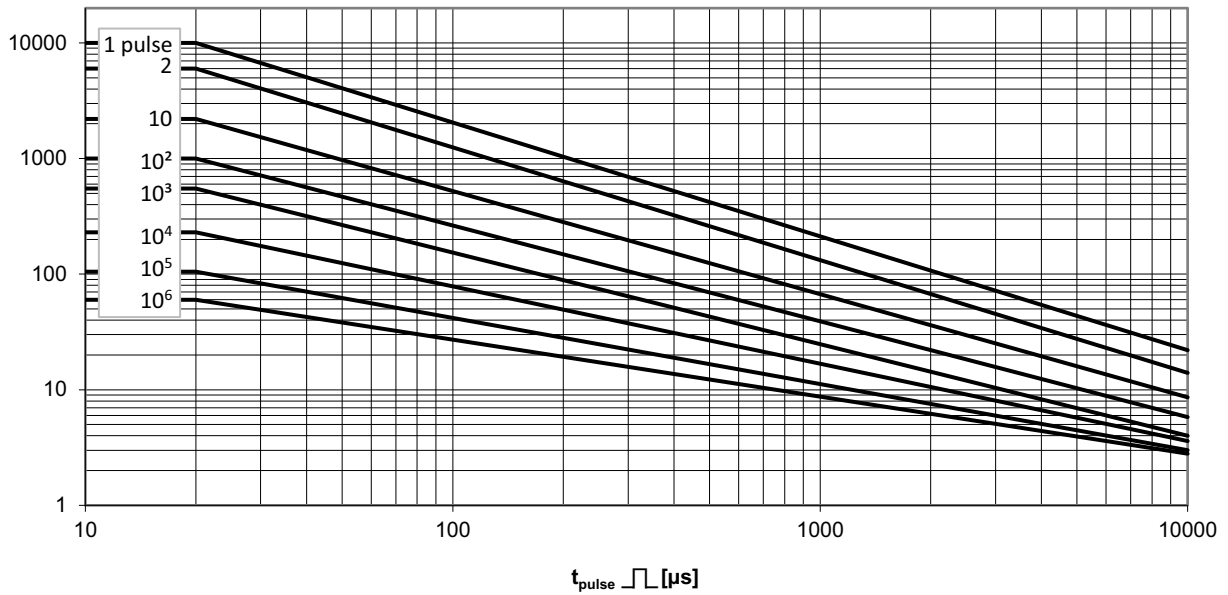



Disclaimer

ALL PRODUCT, PRODUCT SPECIFICATIONS AND DATA ARE SUBJECT TO CHANGE WITHOUT NOTICE TO IMPROVE RELIABILITY, FUNCTION OR DESIGN OR OTHERWISE.

Vishay Intertechnology, Inc., its affiliates, agents, and employees, and all persons acting on its or their behalf (collectively, "Vishay"), disclaim any and all liability for any errors, inaccuracies or incompleteness contained in any datasheet or in any other disclosure relating to any product.

Vishay makes no warranty, representation or guarantee regarding the suitability of the products for any particular purpose or the continuing production of any product. To the maximum extent permitted by applicable law, Vishay disclaims (i) any and all liability arising out of the application or use of any product, (ii) any and all liability, including without limitation special, consequential or incidental damages, and (iii) any and all implied warranties, including warranties of fitness for particular purpose, non-infringement and merchantability.

Statements regarding the suitability of products for certain types of applications are based on Vishay's knowledge of typical requirements that are often placed on Vishay products in generic applications. Such statements are not binding statements about the suitability of products for a particular application. It is the customer's responsibility to validate that a particular product with the properties described in the product specification is suitable for use in a particular application. Parameters provided in datasheets and / or specifications may vary in different applications and performance may vary over time. All operating parameters, including typical parameters, must be validated for each customer application by the customer's technical experts. Product specifications do not expand or otherwise modify Vishay's terms and conditions of purchase, including but not limited to the warranty expressed therein.

Hyperlinks included in this datasheet may direct users to third-party websites. These links are provided as a convenience and for informational purposes only. Inclusion of these hyperlinks does not constitute an endorsement or an approval by Vishay of any of the products, services or opinions of the corporation, organization or individual associated with the third-party website. Vishay disclaims any and all liability and bears no responsibility for the accuracy, legality or content of the third-party website or for that of subsequent links.

Except as expressly indicated in writing, Vishay products are not designed for use in medical, life-saving, or life-sustaining applications or for any other application in which the failure of the Vishay product could result in personal injury or death. Customers using or selling Vishay products not expressly indicated for use in such applications do so at their own risk. Please contact authorized Vishay personnel to obtain written terms and conditions regarding products designed for such applications.

No license, express or implied, by estoppel or otherwise, to any intellectual property rights is granted by this document or by any conduct of Vishay. Product names and markings noted herein may be trademarks of their respective owners.