

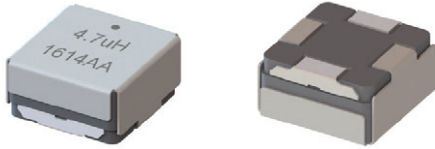

IHLE® High Current Inductors With E-Field Shield



LINKS TO ADDITIONAL RESOURCES



APPLICATIONS

- Automotive Domain Control Units (DCU) and transmission / engine control
- DC/DC converters for infotainment, navigation systems
- Noise suppression for motors and power supplies
- LED lighting drivers

FEATURES

- High temperature up to 155 °C
- Reduces radiated E-field up to 20 dB ⁽¹⁾
- Reduces crosstalk and magnetic B-field leakage by 6 dB to nearby components
- Shields inductor from external noise
- Four terminals provide improved shock and vibration performance and greater mounting stability
- Integrated E-Field shield eliminates need for separate shielding
- AEC-Q200 qualified
- Patented shield construction
- IHLE design; PATENT(S): www.vishay.com/patents
- Material categorization: for definitions of compliance please see www.vishay.com/doc?99912



Note

⁽¹⁾ Maximum E-Field reduction is realized when the IHLE shield is connected to ground

STANDARD ELECTRICAL SPECIFICATIONS						
PART NUMBER	L ₀ INDUCTANCE ± 20 % AT 100 kHz, 0.25 V, 0 A (µH)	DCR TYP. 25 °C (mΩ)	DCR MAX. 25 °C (mΩ)	HEAT RATING CURRENT DC TYP. (A) ⁽¹⁾	SATURATION CURRENT DC TYP. (A) ⁽²⁾	SRF TYP. (MHz)
IHLE5050FHERR33M5A	0.33	0.83	0.92	62	44	79.9
IHLE5050FHERR47M5A	0.47	1.05	1.16	54	42	65.6
IHLE5050FHERR56M5A	0.56	1.24	1.33	50	32	63.1
IHLE5050FHERR68M5A	0.68	1.33	1.42	40	29	48.1
IHLE5050FHER1R0M5A	1.0	1.65	1.77	40	26	33.4
IHLE5050FHER1R2M5A	1.2	1.98	2.12	29	24.5	32.0
IHLE5050FHER1R5M5A	1.5	2.4	2.57	27.5	23.5	29.2
IHLE5050FHER2R2M5A	2.2	3.43	3.67	25.5	21.5	23.3
IHLE5050FHER3R3M5A	3.3	5.08	5.44	20.2	16.7	17.8
IHLE5050FHER4R7M5A	4.7	7.41	7.93	19.7	18.5	15.8
IHLE5050FHER5R6M5A	5.6	8.51	9.11	16.8	14.2	12.3
IHLE5050FHER6R8M5A	6.8	11.3	12.09	14.9	14.1	13.4
IHLE5050FHER8R2M5A	8.2	13.2	14.12	13.2	7.6	10.3
IHLE5050FHER100M5A	10	16.60	17.76	12.1	7.8	10.7
IHLE5050FHER120M5A	12	19.00	20.33	11.4	7.9	9.5
IHLE5050FHER150M5A	15	24.00	25.68	10.1	7.7	8.8
IHLE5050FHER220M5A	22	31.30	33.49	9.0	6.3	6.6
IHLE5050FHER330M5A	33	46.03	49.25	6.9	6.2	5.5
IHLE5050FHER470M5A	47	77.00	79.60	5.6	5.7	4.1
IHLE5050FHER820M5A	82	141.10	150.98	3.7	3.7	3.0
IHLE5050FHER101M5A	100	175.00	205.00	3.1	4.3	2.8

Notes

- All test data is referenced to 25 °C ambient
- Operating temperature range -55 °C to +155 °C
- The part temperature (ambient + temp. rise) should not exceed 155 °C under worst case operating conditions. Circuit design, component placement, PCB trace size and thickness, airflow and other cooling provisions all affect the part temperature. Part temperature should be verified in the end application
- Rated operating voltage, across inductor (V1) = 75 V
- Rated isolation voltage, inductor lead to shield (V2) = 100 V
- ⁽¹⁾ DC current (A) that will cause an approximate ΔT of 40 °C
- ⁽²⁾ DC current (A) that will cause L₀ to drop approximately 20 %

PATENT(S): www.vishay.com/patents

This Vishay product is protected by one or more United States and international patents.

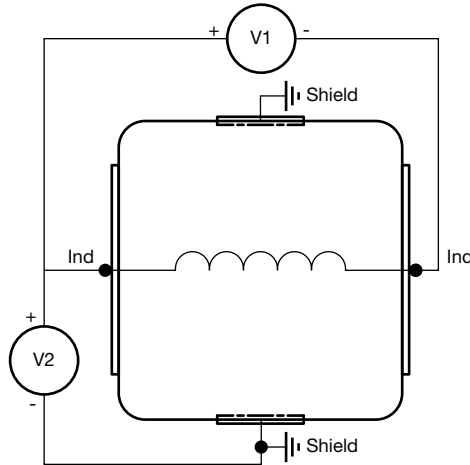

DESCRIPTION					
IHLE-5050FH-5A	1.0 μH	± 20 %	ER	e3	
MODEL	INDUCTANCE VALUE	INDUCTANCE TOLERANCE	PACKAGE CODE	JEDEC® LEAD (Pb)-FREE STANDARD	

GLOBAL PART NUMBER					
I H L E	5 0 5 0 F H	E R	1 R 0	M	5 A
PRODUCT FAMILY	SIZE	PACKAGE CODE	INDUCTANCE VALUE	TOLERANCE	SERIES
		ER = tape and reel	1R0 = 1.0 Ω	M = 20 %	

DIMENSIONS in inches [millimeters]

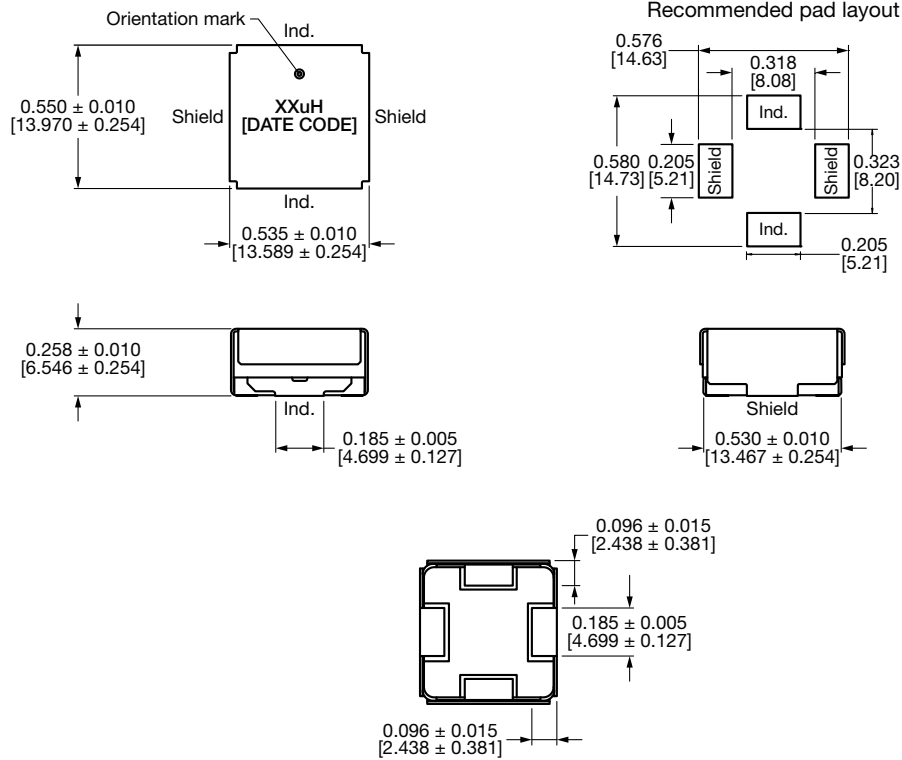

PART MARKING / POCKET TAPE ORIENTATION

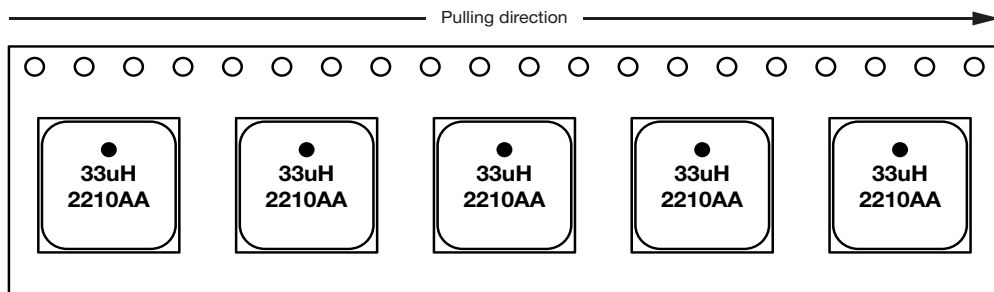



PERFORMANCE GRAPHS

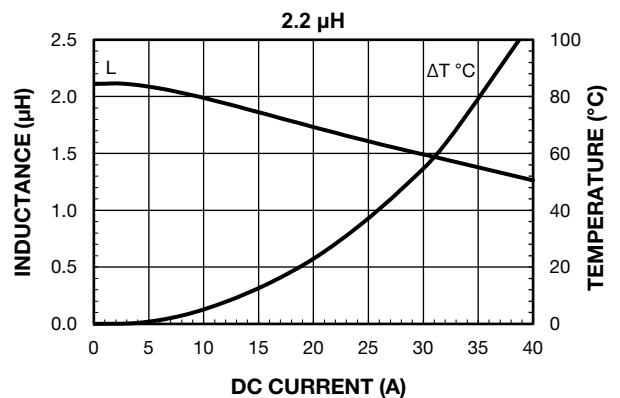
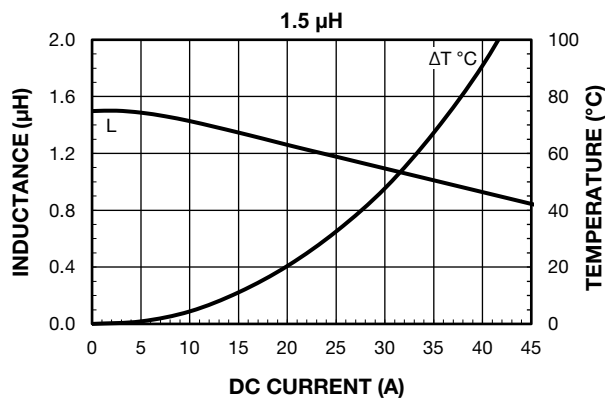
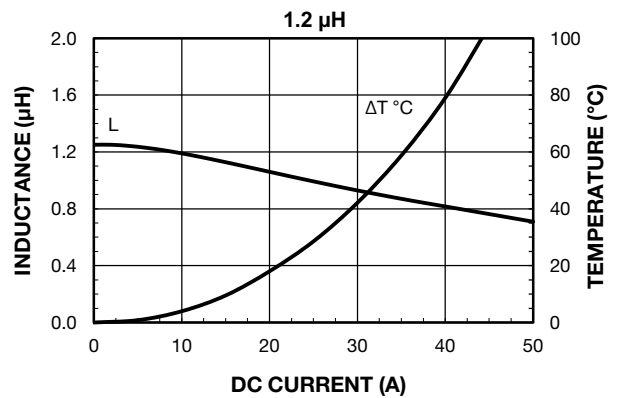
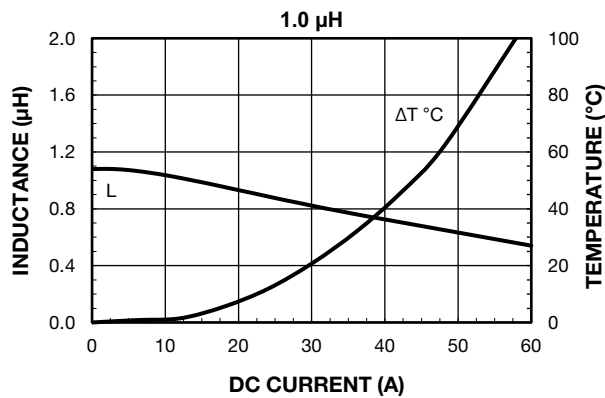
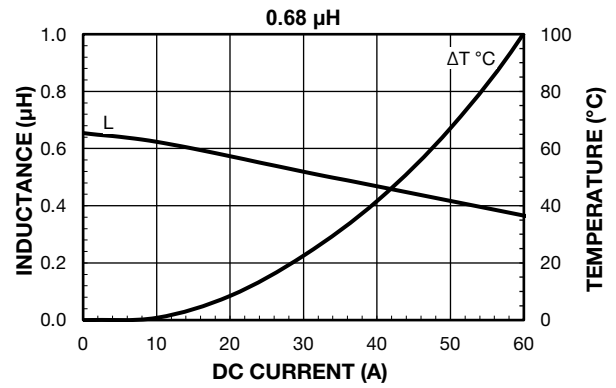
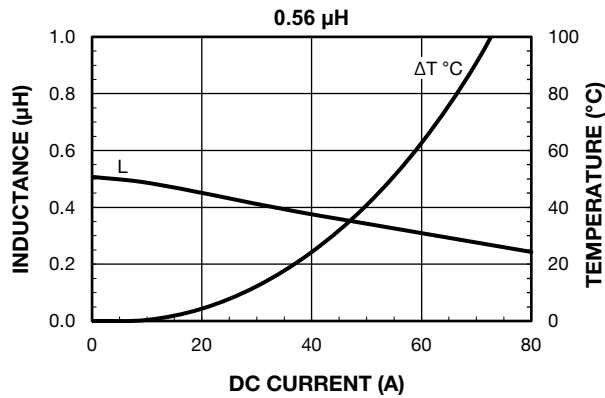
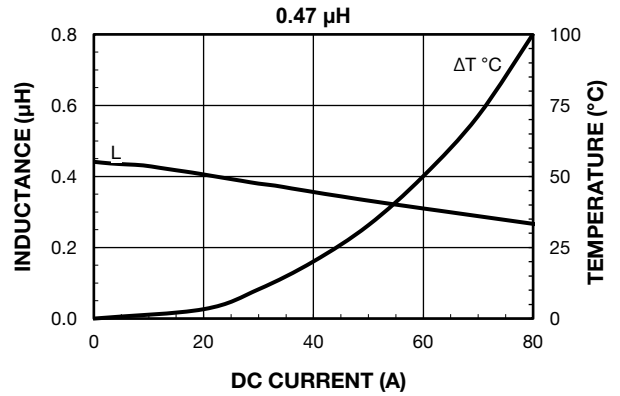
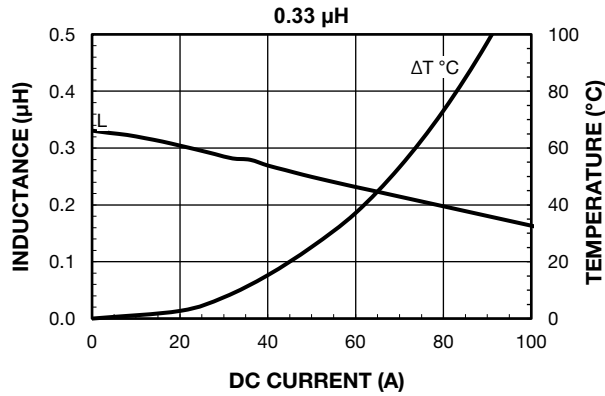



PERFORMANCE GRAPHS

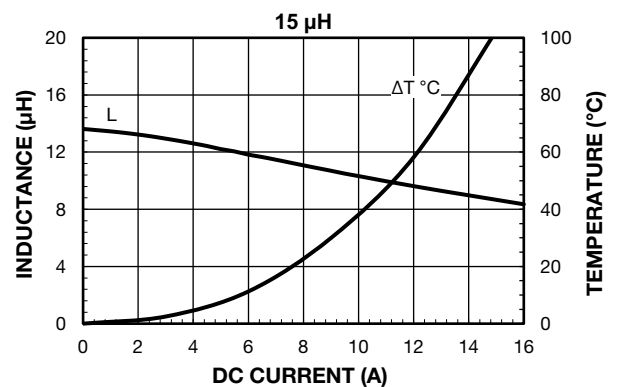
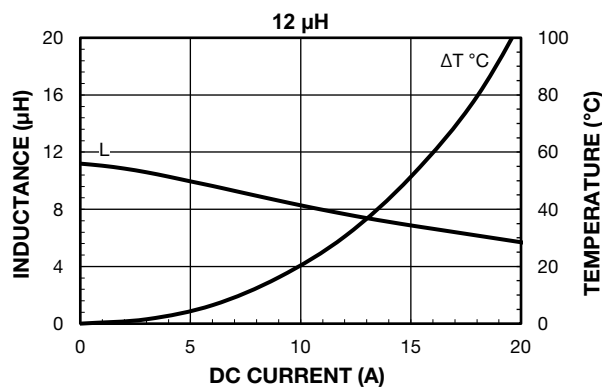
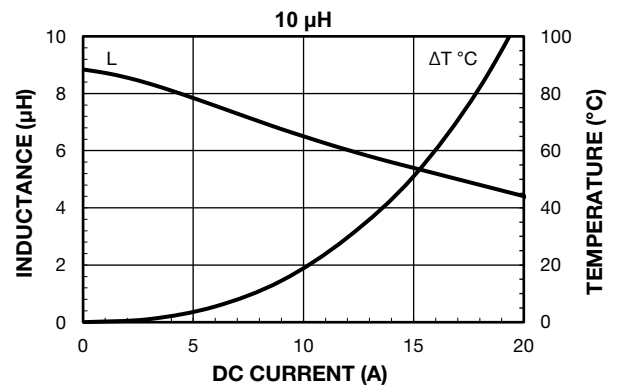
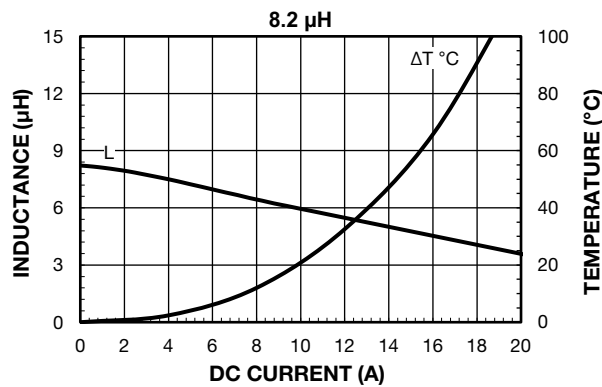
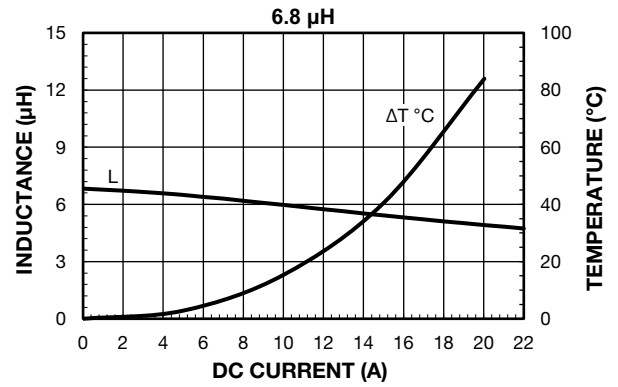
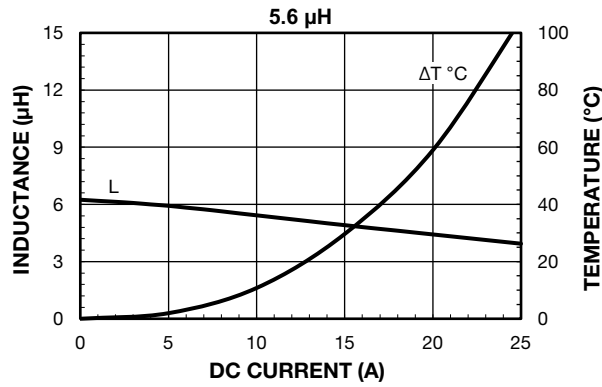
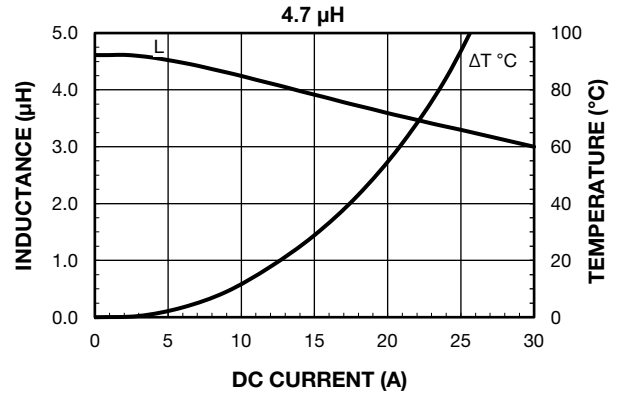
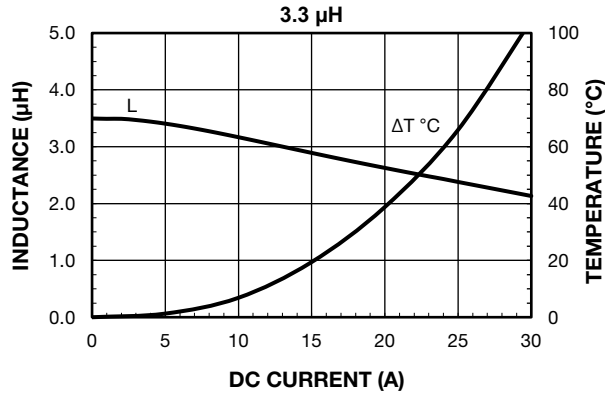



PERFORMANCE GRAPHS

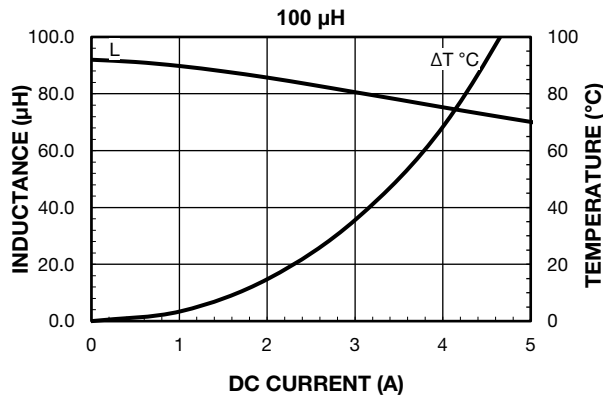
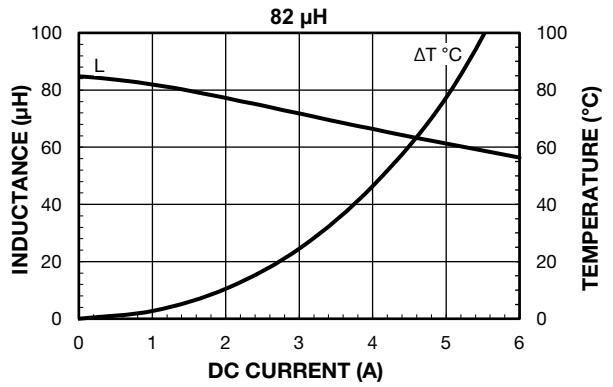
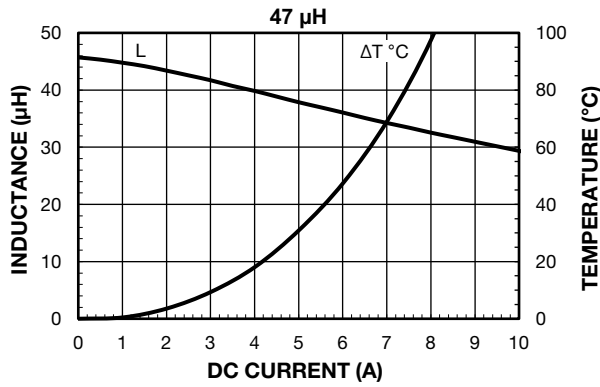
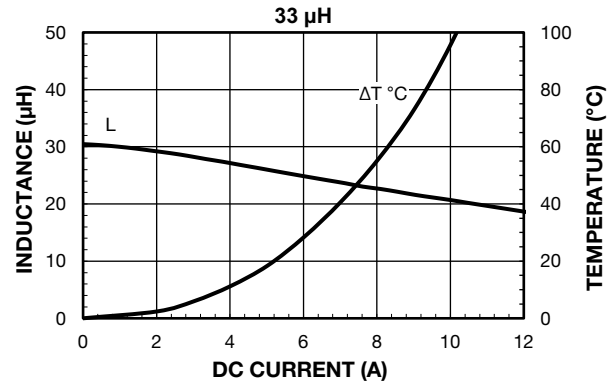
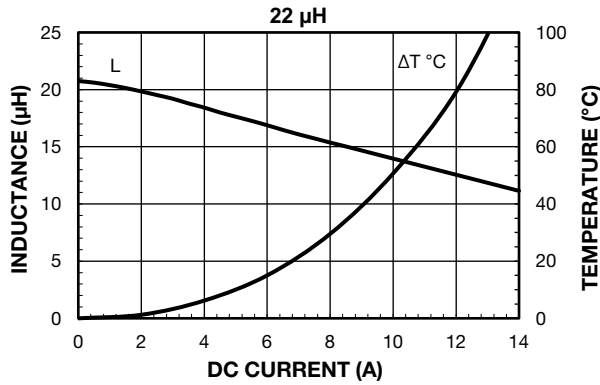

PERFORMANCE GRAPHS: INDUCTANCE AND Q VS. FREQUENCY

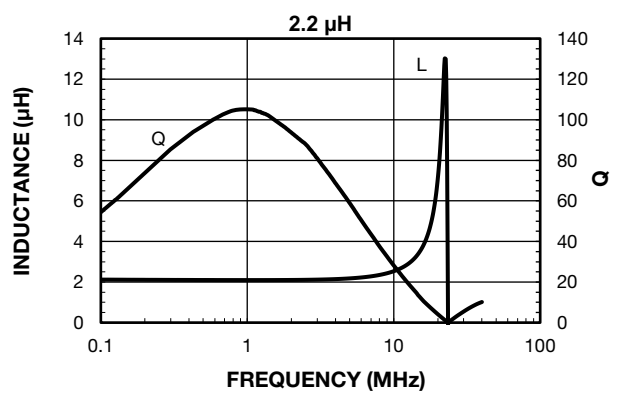
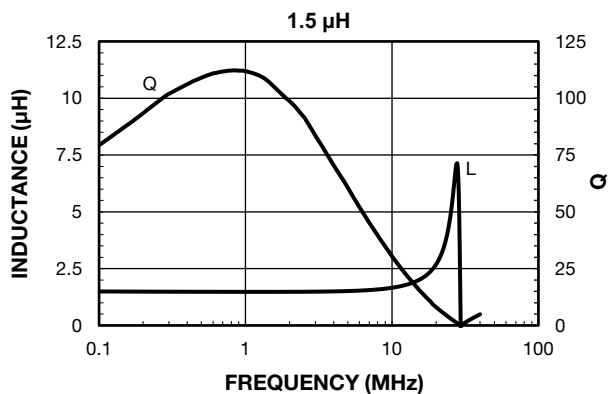
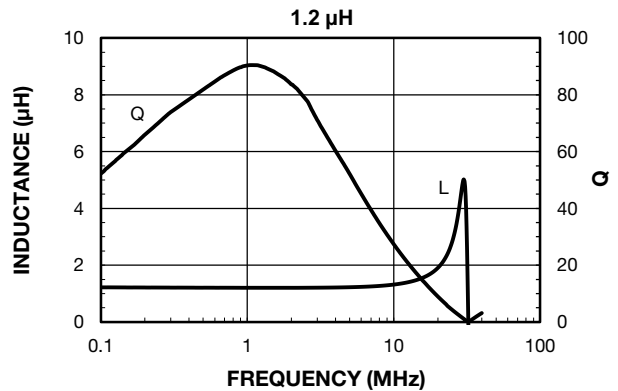
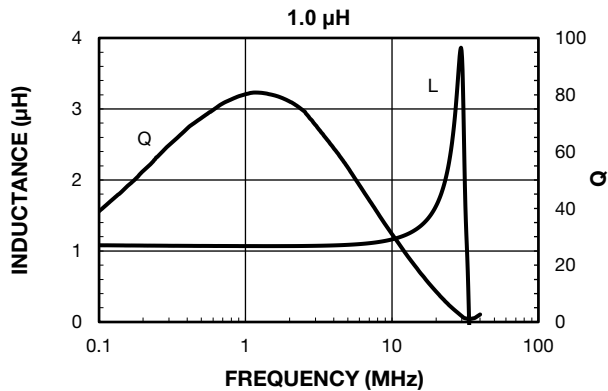
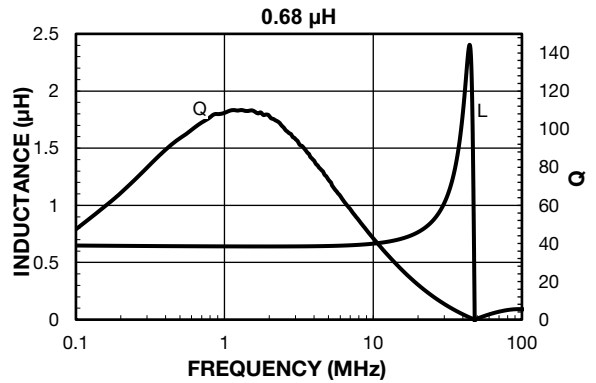
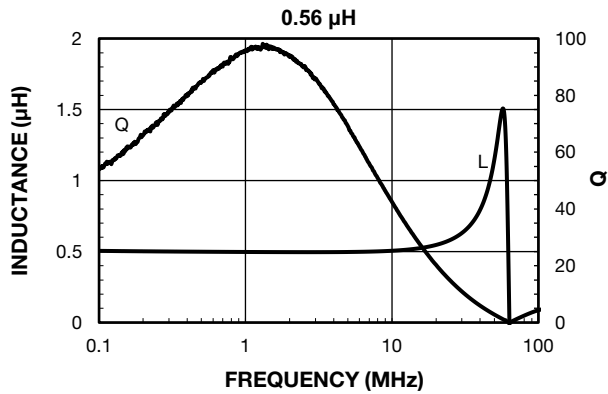
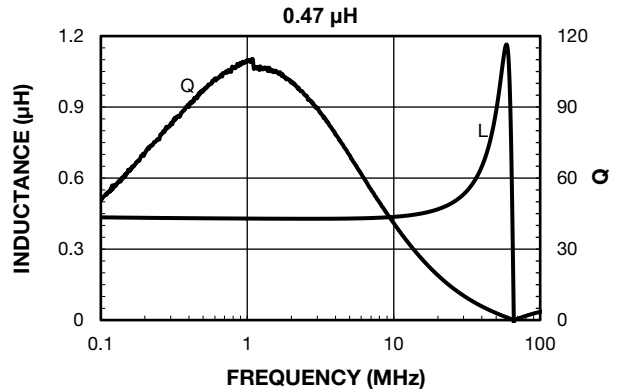
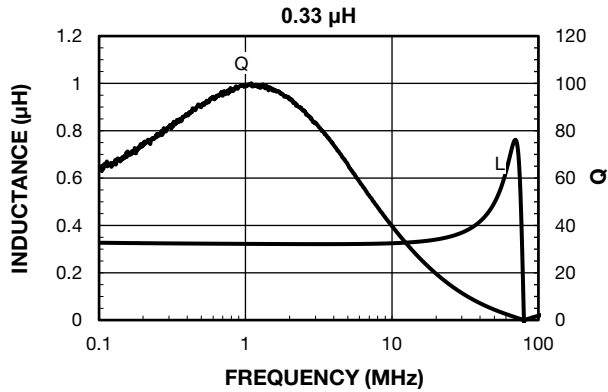

PERFORMANCE GRAPHS: INDUCTANCE AND Q VS. FREQUENCY

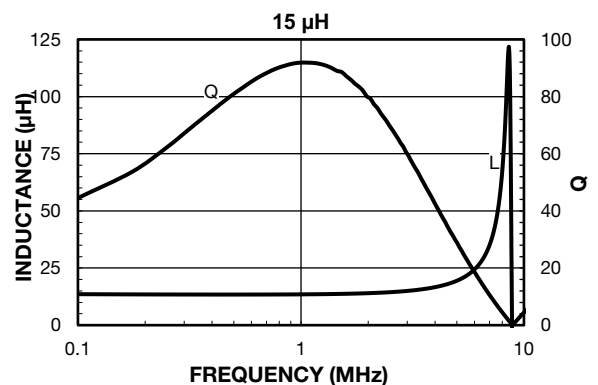
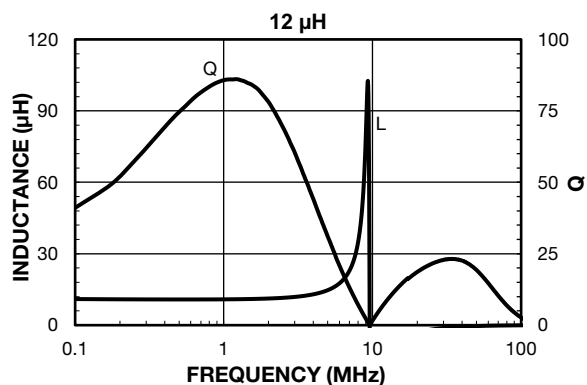
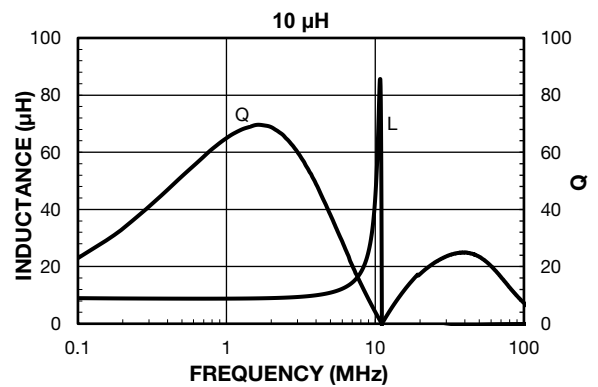
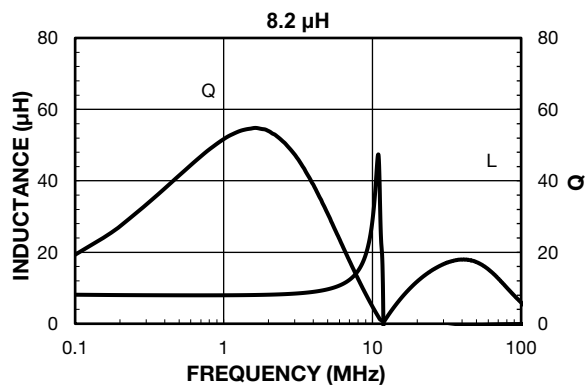
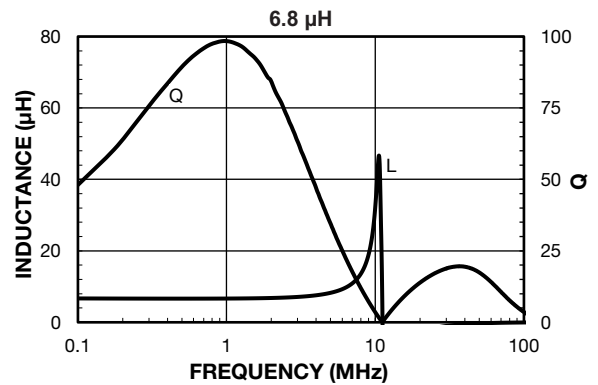
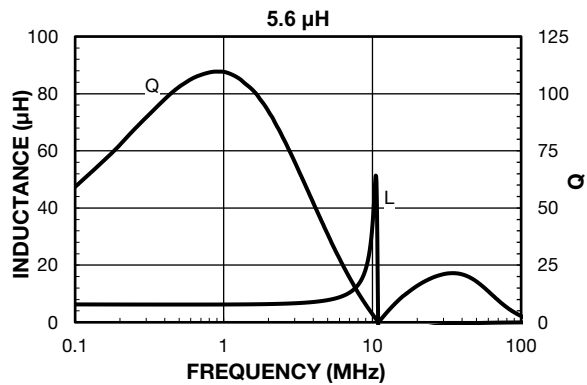
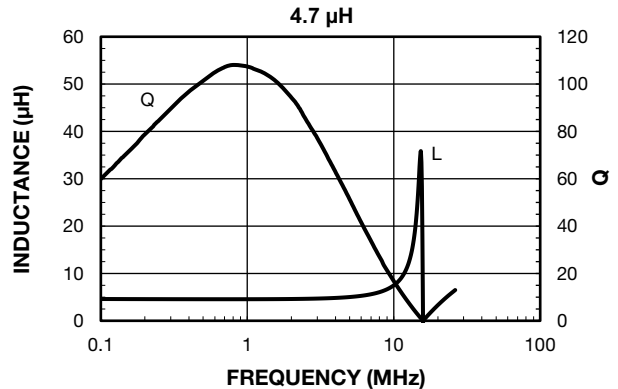
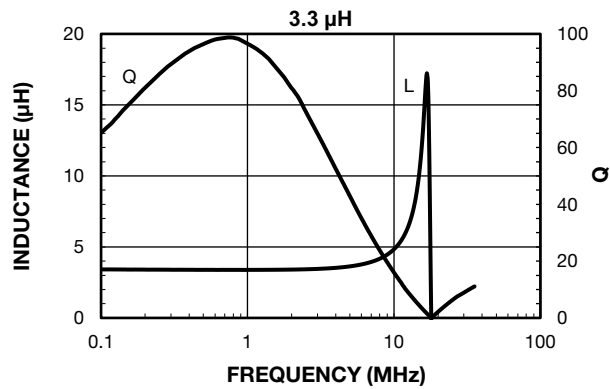



PERFORMANCE GRAPHS: INDUCTANCE AND Q VS. FREQUENCY

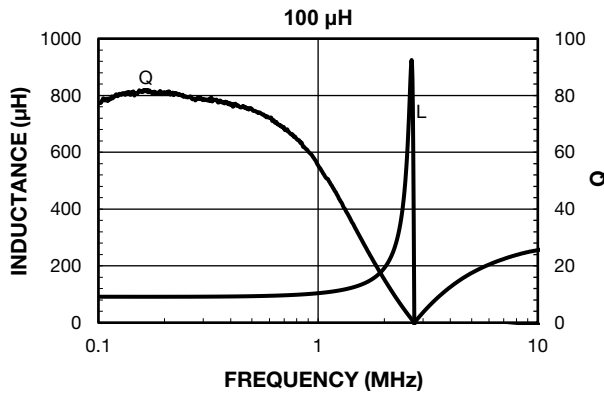
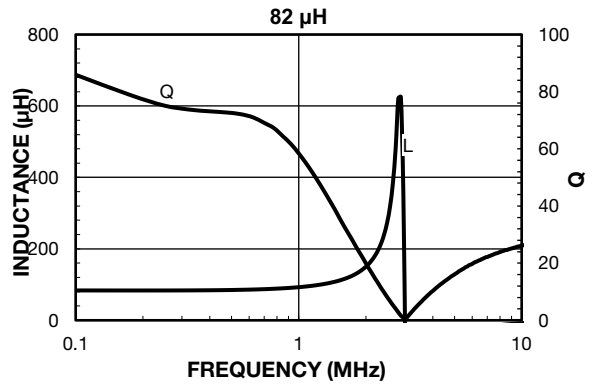
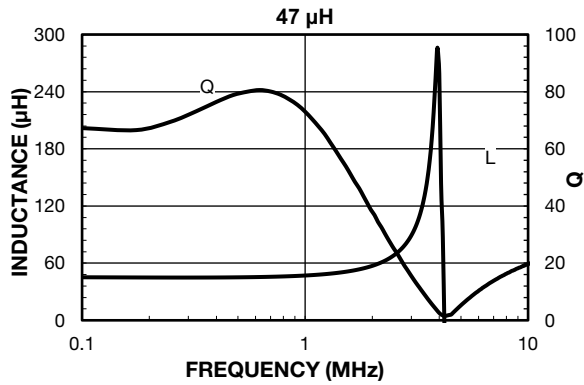
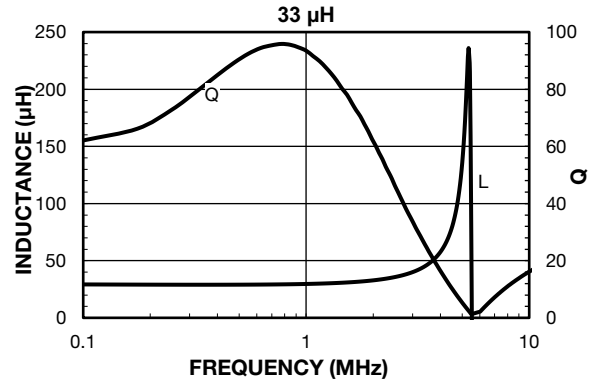
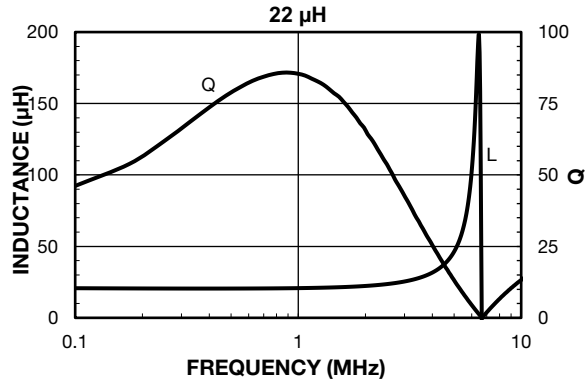



Disclaimer

ALL PRODUCT, PRODUCT SPECIFICATIONS AND DATA ARE SUBJECT TO CHANGE WITHOUT NOTICE TO IMPROVE RELIABILITY, FUNCTION OR DESIGN OR OTHERWISE.

Vishay Intertechnology, Inc., its affiliates, agents, and employees, and all persons acting on its or their behalf (collectively, "Vishay"), disclaim any and all liability for any errors, inaccuracies or incompleteness contained in any datasheet or in any other disclosure relating to any product.

Vishay makes no warranty, representation or guarantee regarding the suitability of the products for any particular purpose or the continuing production of any product. To the maximum extent permitted by applicable law, Vishay disclaims (i) any and all liability arising out of the application or use of any product, (ii) any and all liability, including without limitation special, consequential or incidental damages, and (iii) any and all implied warranties, including warranties of fitness for particular purpose, non-infringement and merchantability.

Statements regarding the suitability of products for certain types of applications are based on Vishay's knowledge of typical requirements that are often placed on Vishay products in generic applications. Such statements are not binding statements about the suitability of products for a particular application. It is the customer's responsibility to validate that a particular product with the properties described in the product specification is suitable for use in a particular application. Parameters provided in datasheets and / or specifications may vary in different applications and performance may vary over time. All operating parameters, including typical parameters, must be validated for each customer application by the customer's technical experts. Product specifications do not expand or otherwise modify Vishay's terms and conditions of purchase, including but not limited to the warranty expressed therein.

Hyperlinks included in this datasheet may direct users to third-party websites. These links are provided as a convenience and for informational purposes only. Inclusion of these hyperlinks does not constitute an endorsement or an approval by Vishay of any of the products, services or opinions of the corporation, organization or individual associated with the third-party website. Vishay disclaims any and all liability and bears no responsibility for the accuracy, legality or content of the third-party website or for that of subsequent links.

Except as expressly indicated in writing, Vishay products are not designed for use in medical, life-saving, or life-sustaining applications or for any other application in which the failure of the Vishay product could result in personal injury or death. Customers using or selling Vishay products not expressly indicated for use in such applications do so at their own risk. Please contact authorized Vishay personnel to obtain written terms and conditions regarding products designed for such applications.

No license, express or implied, by estoppel or otherwise, to any intellectual property rights is granted by this document or by any conduct of Vishay. Product names and markings noted herein may be trademarks of their respective owners.