



## Surface Mount Multilayer Ceramic Chip Capacitors With Lead-Bearing Finish Termination



### FEATURES

- Tin / lead termination finish - minimum 4 % lead
- Available in 0402 to 1210 body size
- Two dielectrics
- High operating temperature, high reliability
- Wet build process
- Reliable Noble Metal Electrode (NME) system
- AEC-Q200 qualified with PPAP available
- Custom combinations to meet specific need
- Material categorization: for definitions of compliance please see [www.vishay.com/doc?99912](http://www.vishay.com/doc?99912)

### APPLICATIONS

- Low earth orbit satellites (LEO)
- Space
- Aerospace
- Avionic
- Military
- Tin whisker mitigation

### ELECTRICAL SPECIFICATIONS

COG (NP0) DIELECTRIC (1)	
<b>GENERAL SPECIFICATION</b>	
<b>Note</b> Electrical characteristics at +25 °C unless otherwise specified	
<b>Operating Temperature:</b> -55 °C to +150 °C (above +125 °C changed characteristics)	
<b>Capacitance Range:</b> 1 pF to 15 nF	
<b>Voltage Range:</b> 25 V <sub>DC</sub> to 630 V <sub>DC</sub>	
<b>Temperature Coefficient of Capacitance (TCC):</b> 0 ppm/°C ± 30 ppm/°C from -55 °C to +125 °C	
<b>Dissipation Factor (DF):</b> 0.1 % maximum at 1.0 V <sub>RMS</sub> and 1 MHz for values ≤ 1000 pF 0.1 % maximum at 1.0 V <sub>RMS</sub> and 1 kHz for values > 1000 pF	
<b>Insulating Resistance:</b> at +25 °C 100 000 MΩ min. or 1000 ΩF whichever is less at +125 °C 10 000 MΩ min. or 100 ΩF whichever is less	
<b>Aging:</b> 0 % maximum per decade	
<b>Dielectric Strength Test:</b> performed per method 103 of EIA 198-2-E. Applied test voltages	
≤ 250 V <sub>DC</sub> -rated:	250 % of rated voltage
500 V <sub>DC</sub> -rated:	200 % of rated voltage
630 V <sub>DC</sub> -rated:	150 % of rated voltage

X7R DIELECTRIC	
<b>GENERAL SPECIFICATION</b>	
<b>Note</b> Electrical characteristics at +25 °C unless otherwise specified	
<b>Operating Temperature:</b> -55 °C to +150 °C (above +125 °C changed characteristics)	
<b>Capacitance Range:</b> 120 pF to 1 μF	
<b>Voltage Range:</b> 16 V <sub>DC</sub> to 630 V <sub>DC</sub>	
<b>Temperature Coefficient of Capacitance (TCC):</b> ± 15 % from -55 °C to +125 °C, with 0 V <sub>DC</sub> applied	
<b>Dissipation Factor (DF):</b> 16 V, 25 V ratings: 3.5 % maximum at 1.0 V <sub>RMS</sub> and 1 kHz > 25 V ratings: 2.5 % maximum at 1.0 V <sub>RMS</sub> and 1 kHz	
<b>Insulating Resistance:</b> at +25 °C 100 000 MΩ min. or 1000 ΩF whichever is less at +125 °C 10 000 MΩ min. or 100 ΩF whichever is less	
<b>Aging Rate:</b> 1 % maximum per decade	
<b>Dielectric Strength Test:</b> performed per method 103 of EIA 198-2-E. Applied test voltages	
≤ 250 V <sub>DC</sub> -rated:	250 % of rated voltage
500 V <sub>DC</sub> -rated:	min. 150 % of rated voltage
630 V <sub>DC</sub> -rated:	min. 120 % of rated voltage

**Note**

(1) Under qualification; contact factory for availability

QUICK REFERENCE DATA				
DIELECTRIC	CASE CODE	MAXIMUM VOLTAGE (V)	CAPACITANCE	
			MINIMUM	MAXIMUM
COG (NP0)	0402	100	1.0 pF	220 pF
	0603	200	1.0 pF	820 pF
	0805	500	1.0 pF	3.9 nF
	1206	630	1.0 pF	8.2 nF
	1210	630	100 pF	12 nF
X7R	0402	100	120 pF	33 nF
	0603	200	330 pF	150 nF
	0805	200	330 pF	470 nF
	1206	630	220 pF	1.0 $\mu$ F
	1210	630	390 pF	1.0 $\mu$ F

**Note**

- Detail ratings see "Selection Chart"

ORDERING INFORMATION								
VJ0805	Y	102	K	L	A	A	C	32
CASE CODE	DIELECTRIC	CAPACITANCE NOMINAL CODE	CAPACITANCE TOLERANCE	TERMINATION	DC VOLTAGE RATING <sup>(1)</sup>	MARKING	PACKAGING	PROCESS CODE
0402 0603 0805 1206 1210	A, D = COG (NP0) <sup>(2)</sup> Y = X7R	Expressed in picofarads (pF). The first two digits are significant, the third is a multiplier. An "R" indicates a decimal point. <b>Examples</b> 4R7 = 4.7 pF 102 = 1000 pF	B = $\pm 0.10$ pF C = $\pm 0.25$ pF D = $\pm 0.5$ pF F = $\pm 1$ % G = $\pm 2$ % J = $\pm 5$ % K = $\pm 10$ % M = $\pm 20$ % <b>Note</b> COG (NP0): B, C, D < 10 pF F, G, J, K $\geq 10$ pF X7R: J, K, M	L = Ni barrier with tin lead plated finish min. 4 % lead	J = 16 V X = 25 V A = 50 V B = 100 V C = 200 V P = 250 V E = 500 V L = 630 V	A = unmarked	T = 7" reel / plastic tape C = 7" reel / paper tape J = 7" reel (low quantity) R = 11 1/4" / 13" reel / plastic tape P = 11 1/4" / 13" reel / paper tape	32 = AEC-Q200 qualified with tin / lead termination finish

**Notes**

- DC voltage rating should not be exceeded in application. Other application factors may affect the MLCC performance. Consult for questions: [mlcc@vishay.com](mailto:mlcc@vishay.com)
- Consult Selection Chart table for correct dielectric code

DIMENSIONS in inches (millimeters)						
CASE CODE	STYLE	LENGTH (L)	WIDTH (W)	MAXIMUM THICKNESS (T)	TERMINATIONS PAD (P)	
					MINIMUM	MAXIMUM
0402	VJ0402	0.040 + 0.004 / - 0.002 (1.00 + 0.10 / - 0.05)	0.020 + 0.004 / - 0.002 (0.50 + 0.10 / - 0.05)	0.024 (0.60)	0.004 (0.10)	0.016 (0.41)
0603	VJ0603	0.063 $\pm$ 0.006 (1.60 $\pm$ 0.15)	0.031 $\pm$ 0.006 (0.80 $\pm$ 0.15)	0.038 (0.97)	0.012 (0.30)	0.024 (0.60)
0805	VJ0805	0.079 $\pm$ 0.008 (2.00 $\pm$ 0.20)	0.049 $\pm$ 0.008 (1.25 $\pm$ 0.20)	0.057 (1.45)	0.010 (0.25)	0.028 (0.71)
1206	VJ1206	0.126 $\pm$ 0.010 (3.20 $\pm$ 0.25)	0.063 $\pm$ 0.010 (1.60 $\pm$ 0.25)	0.067 (1.70)	0.010 (0.25)	0.028 (0.71)
1210	VJ1210	0.126 $\pm$ 0.010 (3.20 $\pm$ 0.25)	0.098 $\pm$ 0.010 (2.50 $\pm$ 0.25)	0.076 (1.94)	0.010 (0.25)	0.028 (0.71)



SELECTION CHART										
DIELECTRIC		COG (NP0)								
STYLE		VJ0402		VJ0603			VJ0805			
CASE CODE		0402		0603			0805			
VOLTAGE (V <sub>DC</sub> )		25 / 50	100	50	100	200	50	100	200	500
VOLTAGE CODE		X / A	B	A	B	C	A	B	C	E
CAP. CODE	CAP.									
1R0	1.0 pF	••	••	••	••	••	••	••	••	••
1R2	1.2 pF	••	••	••	••	••	••	••	••	••
1R5	1.5 pF	••	••	••	••	••	••	••	••	••
1R8	1.8 pF	••	••	••	••	••	••	••	••	••
2R2	2.2 pF	••	••	••	••	••	••	••	••	••
2R7	2.7 pF	••	••	••	••	••	••	••	••	••
3R3	3.3 pF	••	••	••	••	••	••	••	••	••
3R9	3.9 pF	••	••	••	••	••	••	••	••	••
4R7	4.7 pF	••	••	••	••	••	••	••	••	••
5R6	5.6 pF	••	••	••	••	••	••	••	••	••
6R8	6.8 pF	••	••	••	••	••	••	••	••	••
8R2	8.2 pF	••	••	••	••	••	••	••	••	••
100	10 pF	••	••	••	••	••	••	••	••	••
120	12 pF	••	••	••	••	••	••	••	••	••
150	15 pF	••	••	••	••	••	••	••	••	••
180	18 pF	••	••	••	••	••	••	••	••	••
220	22 pF	••	••	••	••	••	••	••	••	••
270	27 pF	••	••	••	••	••	••	••	••	••
330	33 pF	••	••	••	••	••	••	••	••	••
390	39 pF	••	••	••	••	••	••	••	••	••
470	47 pF	••	••	••	••	••	••	••	••	••
560	56 pF	••	••	••	••	••	••	••	••	••
680	68 pF	••	••	••	••	••	••	••	••	••
820	82 pF	••	••	••	••	••	••	••	••	••
101	100 pF	••	••	••	••	••	••	••	••	••
121	120 pF	••	••	••	••	••	••	••	••	••
151	150 pF	••	••	••	••	••	••	••	••	••
181	180 pF	••	••	••	••	•	••	••	••	••
221	220 pF	••	••	••	••	•	••	••	••	•
271	270 pF	••	••	••	••	•	••	••	••	•
331	330 pF	••	••	••	••	•	••	••	••	•
391	390 pF	••	••	••	••	•	••	••	••	•
471	470 pF	••	••	••	••	•	••	••	•	•
561	560 pF	••	••	••	••	•	••	••	•	•
681	680 pF	••	••	••	••	•	••	••	•	•
821	820 pF	••	••	••	••	•	••	••	•	•

**Notes**

•• Paper tape, • Plastic tape

• These values use dielectric code "D". All other NP0 (COG) part numbers use dielectric code "A"



SELECTION CHART										
DIELECTRIC		COG (NP0)								
STYLE		VJ0402		VJ0603			VJ0805			
CASE CODE		0402		0603			0805			
VOLTAGE (V <sub>DC</sub> )		25 / 50	100	50	100	200	50	100	200	500
VOLTAGE CODE		X / A	B	A	B	C	A	B	C	E
CAP. CODE	CAP.									
102	1.0 nF						••	••	•	
122	1.2 nF						••	•		
152	1.5 nF						••	•		
182	1.8 nF						•	•		
222	2.2 nF						•			
272	2.7 nF						•			
332	3.3 nF						•			
392	3.9 nF						•			
472	4.7 nF									
562	5.6 nF									
682	6.8 nF									
822	8.2 nF									
103	10 nF									
123	12 nF									
153	15 nF									
183	18 nF									
223	22 nF									
273	27 nF									
333	33 nF									
393	39 nF									
473	47 nF									
563	56 nF									

**Note**

•• Paper tape, • Plastic tape



SELECTION CHART									
DIELECTRIC		COG (NP0)							
STYLE		VJ1206				VJ1210			
CASE CODE		1206				1210			
VOLTAGE (V <sub>DC</sub> )		50	100	200	500 / 630	50	100	200	500 / 630
VOLTAGE CODE		A	B	C	E / L	A	B	C	E / L
CAP. CODE	CAP.								
1R0	1.0 pF	••	••	••	••				
1R2	1.2 pF	••	••	••	••				
1R5	1.5 pF	••	••	••	••				
1R8	1.8 pF	••	••	••	••				
2R2	2.2 pF	••	••	••	••				
2R7	2.7 pF	••	••	••	••				
3R3	3.3 pF	••	••	••	••				
3R9	3.9 pF	••	••	••	••				
4R7	4.7 pF	••	••	••	••				
5R6	5.6 pF	••	••	••	••				
6R8	6.8 pF	••	••	••	••				
8R2	8.2 pF	••	••	••	••				
100	10 pF	••	••	••	••				
120	12 pF	••	••	••	••				
150	15 pF	••	••	••	••				
180	18 pF	••	••	••	••				
220	22 pF	••	••	••	••				
270	27 pF	••	••	••	••				
330	33 pF	••	••	••	••				
390	39 pF	••	••	••	••				
470	47 pF	••	••	••	••				
560	56 pF	••	••	••	••				
680	68 pF	••	••	••	••				
820	82 pF	••	••	••	••				
101	100 pF	•	•	•	•	•	•	•	•
121	120 pF	•	•	•	•	•	•	•	•
151	150 pF	•	•	•	•	•	•	•	•
181	180 pF	•	•	•	•	•	•	•	•
221	220 pF	•	•	•	•	•	•	•	•
271	270 pF	•	•	•	•	•	•	•	•
331	330 pF	•	•	•	•	•	•	•	•
391	390 pF	•	•	•	•	•	•	•	•
471	470 pF	•	•	•	•	•	•	•	•
561	560 pF	•	•	•	•	•	•	•	•
681	680 pF	•	•	•	•	•	•	•	•
821	820 pF	•	•	•	•	•	•	•	•

**Notes**

•• Paper tape, • Plastic tape

These values use dielectric code "D". All other NP0 (COG) part numbers use dielectric code "A"



SELECTION CHART									
DIELECTRIC		COG (NP0)							
STYLE		VJ1206				VJ1210			
CASE CODE		1206				1210			
VOLTAGE (V <sub>DC</sub> )		50	100	200	500 / 630	50	100	200	500 / 630
VOLTAGE CODE		A	B	C	E / L	A	B	C	E / L
CAP. CODE	CAP.								
102	1.0 nF	•	•	•	•	•	•	•	•
122	1.2 nF	•	•	•		•	•	•	•
152	1.5 nF	•	•	•		•	•	•	•
182	1.8 nF	•	•	•		•	•	•	•
222	2.2 nF	•	•	•		•	•	•	
272	2.7 nF	•	•	•		•	•	•	
332	3.3 nF	•	•	•		•	•	•	
392	3.9 nF	•	•			•	•	•	
472	4.7 nF	•	•			•	•	•	
562	5.6 nF	•	•			•	•	•	
682	6.8 nF	•	•			•	•	•	
822	8.2 nF	•	•			•	•	•	
103	10 nF					•	•		
123	12 nF					•	•		
153	15 nF								
183	18 nF								
223	22 nF								
273	27 nF								
333	33 nF								
393	39 nF								
473	47 nF								
563	56 nF								

**Note**

•• Paper tape, • Plastic tape



SELECTION CHART															
DIELECTRIC		X7R													
STYLE		VJ0402				VJ0603					VJ0805				
CASE CODE		0402				0603					0805				
VOLTAGE (V <sub>DC</sub> )		16	25	50	100	16	25	50	100	200	16	25	50	100	200
VOLTAGE CODE		J	X	A	B	J	X	A	B	C	J	X	A	B	C
CAP. CODE	CAP.														
121	120 pF	••	••	••	••										
151	150 pF	••	••	••	••										
181	180 pF	••	••	••	••										
221	220 pF	••	••	••	••										
271	270 pF	••	••	••	••										
331	330 pF	••	••	••	••	••	••	••	••	••	••	••	••	••	••
391	390 pF	••	••	••	••	••	••	••	••	••	••	••	••	••	••
471	470 pF	••	••	••	••	••	••	••	••	••	••	••	••	••	••
561	560 pF	••	••	••	••	••	••	••	••	••	••	••	••	••	••
681	680 pF	••	••	••	••	••	••	••	••	••	••	••	••	••	••
821	820 pF	••	••	••	••	••	••	••	••	••	••	••	••	••	••
102	1.0 nF	••	••	••	••	••	••	••	••	••	••	••	••	••	••
122	1.2 nF	••	••	••	••	••	••	••	••	••	••	••	••	••	••
152	1.5 nF	••	••	••	••	••	••	••	••	••	••	••	••	••	••
182	1.8 nF	••	••	••	••	••	••	••	••	••	••	••	••	••	••
222	2.2 nF	••	••	••	••	••	••	••	••	••	••	••	••	••	••
272	2.7 nF	••	••	••	••	••	••	••	••	••	••	••	••	••	••
332	3.3 nF	••	••	••	••	••	••	••	••	••	••	••	••	••	••
392	3.9 nF	••	••	••	••	••	••	••	••	••	••	••	••	••	••
472	4.7 nF	••	••	••	••	••	••	••	••	••	••	••	••	••	••
562	5.6 nF	••	••	••		••	••	••	••		••	••	••	••	••
682	6.8 nF	••	••	••		••	••	••	••		••	••	••	••	••
822	8.2 nF	••	••	••		••	••	••	••		••	••	••	••	••
103	10 nF	••	••	••		••	••	••	••		••	••	••	••	••
123	12 nF	••	••			••	••	••	••		••	••	••	••	•
153	15 nF	••	••			••	••	••	••		••	••	••	••	•
183	18 nF	••	••			••	••	••	••		••	••	••	••	•
223	22 nF	••				••	••	••	••		••	••	••	••	•
273	27 nF	••				••	••	••	••		••	••	••	••	•
333	33 nF	••				••	••	••	••		••	••	••		
393	39 nF					••	••	••	••		••	••	••		
473	47 nF					••	••	••			••	••			
563	56 nF					••	••	••			••	••		•	
683	68 nF					••	••	••			•	•	•	•	
823	82 nF					••	••	••			•	•	•	•	

**Note**

•• Paper tape, • Plastic tape



SELECTION CHART															
DIELECTRIC		X7R													
STYLE		VJ0402				VJ0603					VJ0805				
CASE CODE		0402				0603					0805				
VOLTAGE (V <sub>DC</sub> )		16	25	50	100	16	25	50	100	200	16	25	50	100	200
VOLTAGE CODE		J	X	A	B	J	X	A	B	C	J	X	A	B	C
CAP. CODE	CAP.														
104	100 nF					••	••	••			•	•	•	•	
124	120 nF					•					•	•	•		
154	150 nF					•					•	•	•		
184	180 nF										•	•			
224	220 nF										•	•			
274	270 nF										•	•			
334	330 nF										•	•			
394	390 nF										•				
474	470 nF										•				
564	560 nF														
684	680 nF														
824	820 nF														
105	1.0 μF														
125	1.2 μF														
155	1.5 μF														
185	1.8 μF														
225	2.2 μF														
275	2.7 μF														
335	3.3 μF														
395	3.9 μF														
475	4.7 μF														
565	5.6 μF														
685	6.8 μF														

**Note**

•• Paper tape, • Plastic tape





SELECTION CHART													
DIELECTRIC		X7R											
STYLE		VJ1206						VJ1210					
CASE CODE		1206						1210					
VOLTAGE (V <sub>DC</sub> )		16	25	50	100	200	500 / 630	16	25	50	100	200	500 / 630
VOLTAGE CODE		J	X	A	B	C	E / L	J	X	A	B	C	E / L
CAP. CODE	CAP.												
121	120 pF												
151	150 pF												
181	180 pF												
221	220 pF						•						
271	270 pF						•						
331	330 pF						•						
391	390 pF						•						•
471	470 pF						•						•
561	560 pF						•						•
681	680 pF						•						•
821	820 pF			•	•	•	•						•
102	1.0 nF	•	•	•	•	•	•						•
122	1.2 nF	•	•	•	•	•	•						•
152	1.5 nF	•	•	•	•	•	•						•
182	1.8 nF	•	•	•	•	•	•						•
222	2.2 nF	•	•	•	•	•	•					•	•
272	2.7 nF	•	•	•	•	•	•					•	•
332	3.3 nF	•	•	•	•	•	•					•	•
392	3.9 nF	•	•	•	•	•	•					•	•
472	4.7 nF	•	•	•	•	•	•					•	•
562	5.6 nF	•	•	•	•	•	•					•	•
682	6.8 nF	•	•	•	•	•	•					•	•
822	8.2 nF	•	•	•	•	•	•					•	•
103	10 nF	•	•	•	•	•	•	•	•	•	•	•	•
123	12 nF	•	•	•	•	•	•	•	•	•	•	•	•
153	15 nF	•	•	•	•	•	•	•	•	•	•	•	•
183	18 nF	•	•	•	•	•	•	•	•	•	•	•	•
223	22 nF	•	•	•	•	•	•	•	•	•	•	•	•
273	27 nF	•	•	•	•	•	•	•	•	•	•	•	•
333	33 nF	•	•	•	•	•	•	•	•	•	•	•	•
393	39 nF	•	•	•	•	•	•	•	•	•	•	•	•
473	47 nF	•	•	•	•	•	•	•	•	•	•	•	•
563	56 nF	•	•	•	•	•	•	•	•	•	•	•	•
683	68 nF	•	•	•	•	•	•	•	•	•	•	•	•
823	82 nF	•	•	•	•	•	•	•	•	•	•	•	•

**Note**

- Plastic tape



SELECTION CHART													
DIELECTRIC		X7R											
STYLE		VJ1206						VJ1210					
CASE CODE		1206						1210					
VOLTAGE (V <sub>DC</sub> )		16	25	50	100	200	500 / 630	16	25	50	100	200	500 / 630
VOLTAGE CODE		J	X	A	B	C	E / L	J	X	A	B	C	E / L
CAP. CODE	CAP.												
104	100 nF	•	•	•	•	•		•	•	•	•	•	
124	120 nF	•	•	•	•	•		•	•	•	•	•	
154	150 nF	•	•	•	•			•	•	•	•	•	
184	180 nF	•	•	•	•			•	•	•	•	•	
224	220 nF	•	•	•	•			•	•	•	•		
274	270 nF	•	•	•	•			•	•	•	•		
334	330 nF	•	•	•				•	•	•	•		
394	390 nF	•	•	•				•	•	•	•		
474	470 nF	•	•	•				•	•	•	•		
564	560 nF	•	•					•	•	•			
684	680 nF	•	•					•	•	•			
824	820 nF	•	•					•	•	•			
105	1.0 μF	•	•					•	•	•			
125	1.2 μF												
155	1.5 μF												
185	1.8 μF												
225	2.2 μF												
275	2.7 μF												
335	3.3 μF												
395	3.9 μF												
475	4.7 μF												
565	5.6 μF												
685	6.8 μF												

**Note**

- Plastic tape



STANDARD PACKAGING QUANTITIES (1)(2)						
CASE CODE	TAPE SIZE	7" REEL QUANTITIES			11 1/4" AND 13" REEL QUANTITIES	
		PAPER TAPE PACKAGING CODE "C"	PLASTIC TAPE PACKAGING CODE "T"	LOW QUANTITY PACKAGING CODE "J"	PAPER TAPE PACKAGING CODE "P"	PLASTIC TAPE PACKAGING CODE "R"
0402	8 mm	5000	n/a	1000	10 000	n/a
0603	8 mm	4000	4000	1000	10 000	10 000
0805	8 mm	3000	3000	1000	10 000	10 000
1206 <sup>(3)</sup>	8 mm	3000	2500 / 3000	1000	10 000	9000 / 10 000
1210 <sup>(3)</sup>	8 mm	n/a	2000 / 2500 / 3000	1000	n/a	9000 / 10 000

**Notes**

(1) Reference: EIA standard RS 481 - "Taping of Surface Mount Components for Automatic Placement"

(2) n/a = not available

(3) Packaging quantity can depend from product thickness

**1 - GENERAL CERTIFICATES**

# Quality management system according to IATF 16949	Yes
# Quality management system according to ISO 9001	Yes
# Environmental certification according to ISO 14001	Yes
# Health and safety system according to ISO 45001	Yes

**2 - TECHNICAL REQUIREMENTS**

Unless specified in component specification, these parameters are the minimum requirements for the components.

**2.1 OPERATING TEMPERATURE RANGE**

For standard applications	$T_A$ : -55 °C to +125 °C	See characteristics 2.2
For high temperature applications	$T_A$ : -55 °C to +150 °C	See characteristics 2.2
For ultra high temperature applications	$T_A$ : -55 °C to +175 °C	See characteristics 2.2

**2.2 CHARACTERISTICS**

PARAMETER	CERAMIC TYPE	SYMBOL	RATINGS	TEST CONDITIONS / REMARKS
Rated voltage in temperature range -55 °C to +125 °C	C0G (NP0)	$U_R$	25 V to 630 V	
	X7R		16 V to 630 V	
Derating at higher temperature up to +150 °C	C0G (NP0)		25 V to 100 V	$U_{DC} \leq 1/2 U_R$
	X7R		16 V to 100 V	$U_{DC} \leq 1/2 U_R$ $U_{DC} \leq 1/4 U_R$ for VJ0603Y104*A (100 nF / 50 V)
Derating at higher temperature up to +175 °C	C0G (NP0)		25 V to 100 V	$U_{DC} \leq 1/4 U_R$
	X7R		16 V to 100 V	$U_{DC} \leq 1/4 U_R$
Temperature coefficient in temperature range -55 °C to +125 °C	C0G (NP0)	$\alpha_C$	$\leq \pm 30$ ppm/°C	if $C_R < 10$ pF: $\alpha_C \leq \pm 120$ ppm/°C
	X7R	$\Delta C$	+ 15 % / - 30 %	
Temperature coefficient in temperature range -55 °C to +150 °C	C0G (NP0)	$\alpha_C$	$\leq \pm 30$ ppm/°C	if $C_R < 10$ pF: $\alpha_C \leq \pm 120$ ppm/°C
	X7R	$\Delta C$	+ 15 % / - 30 %	
Temperature coefficient in temperature range -55 °C to +175 °C	X7R	$\Delta C$	+ 15 % / - 50 %	
Dissipation factor in temperature range -55 °C to +175 °C	C0G (NP0)	$\tan \delta$	$\leq 0.0015$	
	X7R		$\leq 0.06$	

**2.3 STORAGE AND HANDLING CONDITIONS**

- (1) Store the components at 5 °C to 40 °C ambient temperature and  $\leq 70$  % relative humidity conditions.  
(2) The product is recommended to be used within a time-frame of 2 years after shipment.  
Check solderability in case extended shelf life beyond the expiry date is needed.

## Precautions:

- Do not store products in an environment containing corrosive elements, especially where chloride gas, sulfide gas, acid, alkali, salt, or the like are present. This may cause corrosion or oxidization of the terminations, which can easily lead to poor soldering.
- Store products on the shelf and avoid exposure to moisture or dust.
- Do not expose products to excessive shock, vibration, direct sunlight, and so on.



## COG (NP0) DIELECTRIC - TYPICAL PARAMETERS

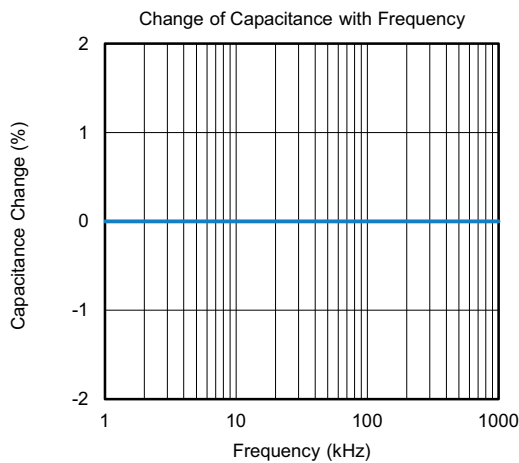
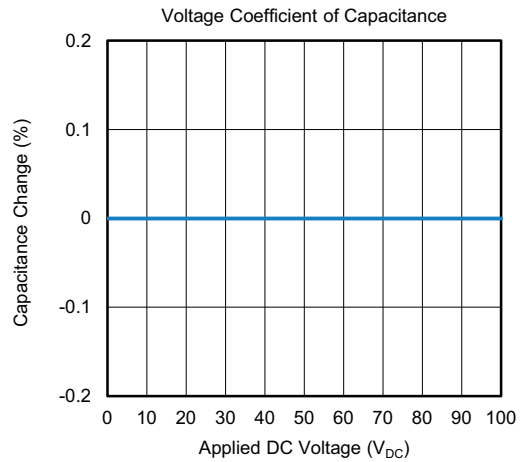
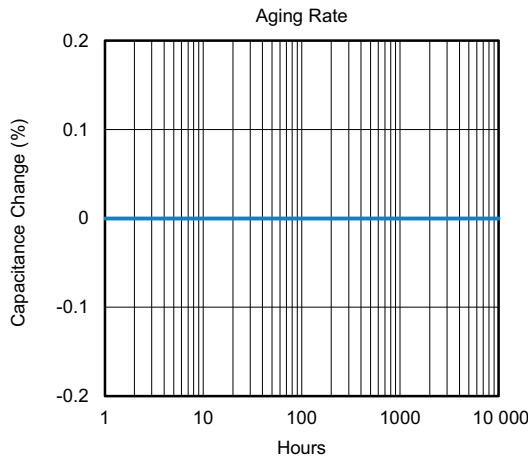
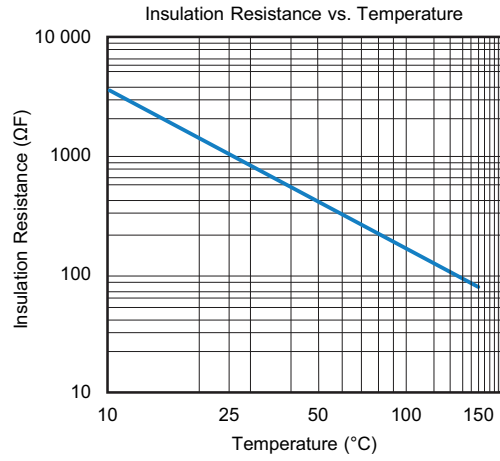
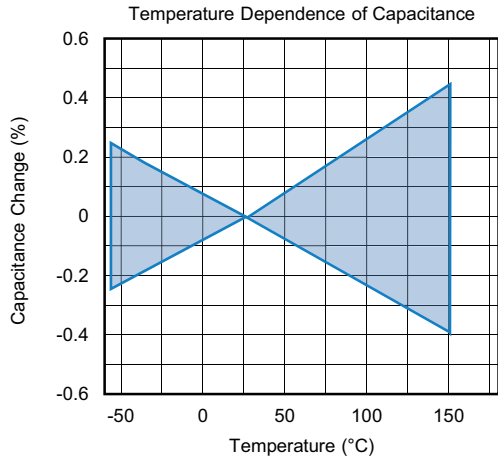



## X7R DIELECTRIC - TYPICAL PARAMETERS

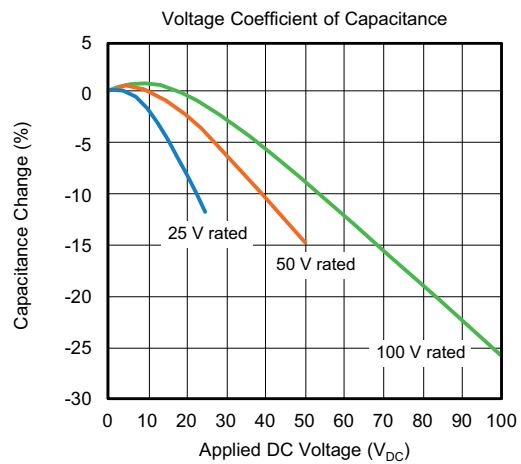
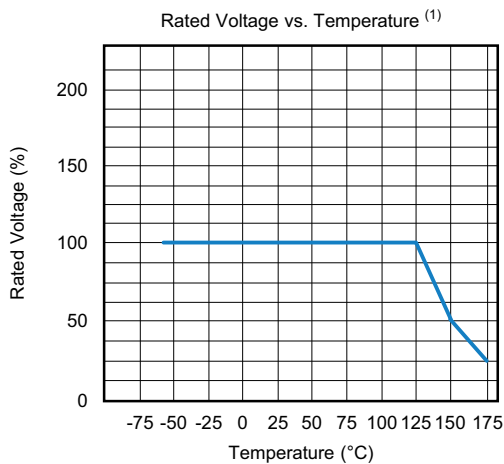
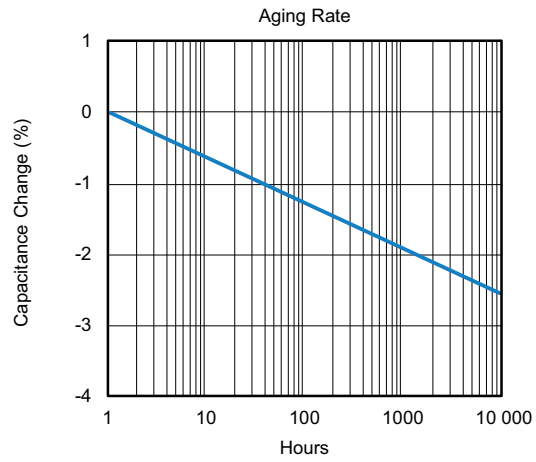
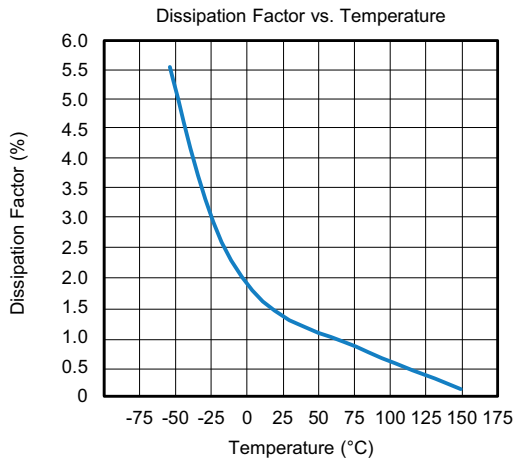
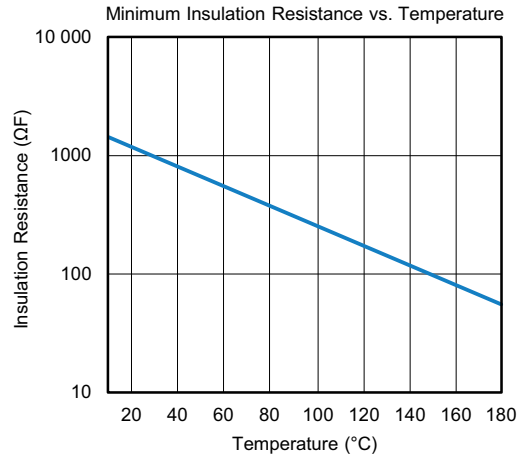
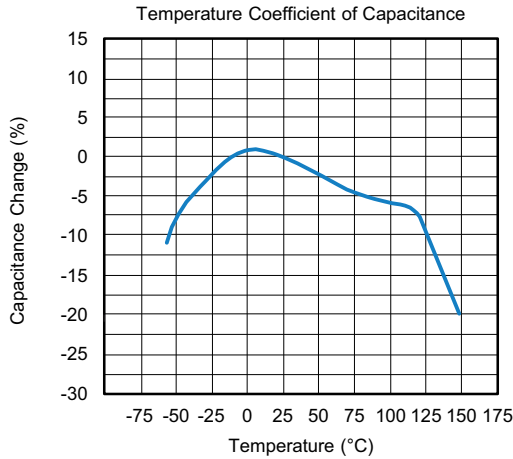

**Note**

<sup>(1)</sup> Except for VJ0603Y104\*A (100 nF / 50 V), see section "2.2 Characteristics"



## X7R DIELECTRIC - TYPICAL PARAMETERS

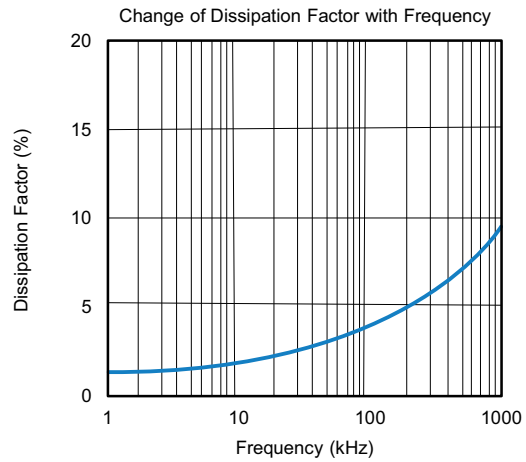
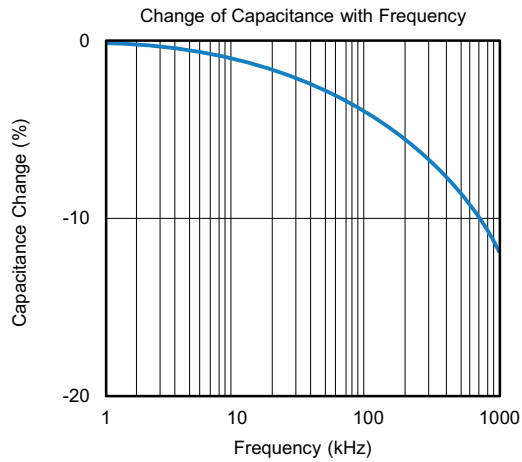
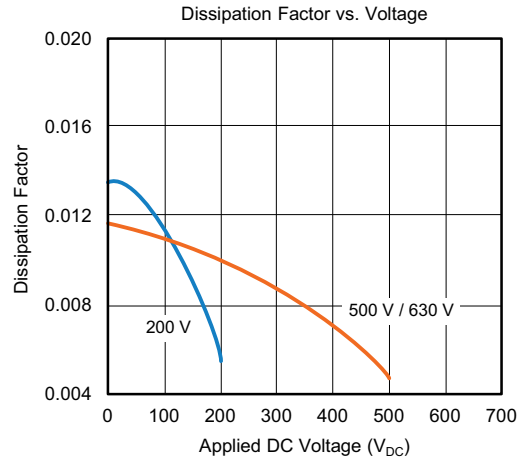
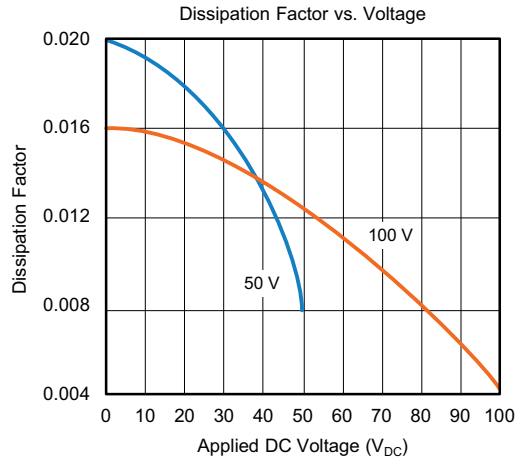



### 3 - LOT ACCEPTANCE TESTS

Process tests available in classes (on request)

GROUP	ACTION
A	Components are tested within the monitoring program of the supplier. The supplier shall submit the part numbers of the selected component to the customer during the component specification discussions.
B	Components (customer P/N) shall be tested quarterly. Records available only on special request by the customer.
C	Test with each shipment. Records are provided on a monthly basis. Customer special requirement; requirement should be determined in a specific component specification.

Upon request the records can be submitted in electronic format on monthly basis.

#### 3.1 THERMAL STRENGTH, THERMAL SHOCK SENSIBILITY

Sample size	200
Handling	Mounted on PCB
Thermal shock	1 x 280 °C, no pre-heat, 5 s to 10 s
IR - test (IRATS)	U = U <sub>R</sub> , T = room temperature, verified
Burn in (BIATS)	Equivalent to 12 h burn-in, 2 x U <sub>R</sub> /125 °C, verification time to failure

Acceptance criteria: zero defects (IRATS and BIATS).

#### 3.2 BOARD FLEX TEST

Sample size	20 pcs/lot
Frequency	At least three different part numbers of one component family matrix per quarter
Max. deflection	8 mm (data to be reported, available on request)

#### 3.3 SOLDERABILITY / RESISTANCE TO SOLDERING HEAT

Temperature profile for reflow soldering of SMD parts IPC/JEDEC-J-STD-020C.

Test is done on a regular basis for samples taken randomly out of the line.

Acceptance criteria: at least 95 % new solder and no detachment or leaching of terminations.

### 4 - ENVIRONMENTAL REQUIREMENTS

A list of the chemical substances content, which must not be used or whose use shall be limited by international law, is available on request.





## 5 - INSPECTION CRITERIA

The supplier shall carry out visual examination with suitable equipment with approximately 10 x magnification and lighting appropriate to the specimen under test and the required quality level.

### Chipping

The components shall be free of cracks or fissures. Small damages which do not deteriorate the performance of the component shall be less than 50 % of the surface of the MLCC as defined in EIA 595.

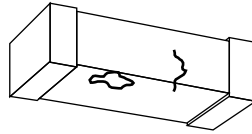

### Delamination or Exposed Electrodes

No visible separation or delamination between layers of the capacitor and no exposed electrodes between the two terminals of the capacitor must be seen.

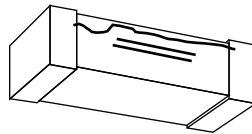

### Metallization

For the metallization, no visible detachment of the metallized terminals and no exposed electrodes must be seen. Defects and gaps in the metallization on each sides of the terminal must not exceed 10 % of the total area (e.g. A, B, C, ...). Leaching shall not exceed 25 %.

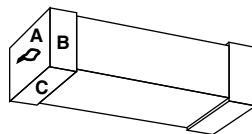

### Electrode Distance

The ceramic body shall be free of any conducting material between the terminals which reduces the distance of the electrodes. The minimum distance "D" is 400  $\mu\text{m}$  for all package sizes, except 0402. For the component package 0402 the minimum distance is 200  $\mu\text{m}$ .

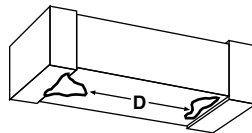

## 6 - BOARD FLEX TEST CONDITIONS

### 6.1 BOARD FLEX DEFINITIONS OF TEST

PCB thickness =  $(1.6 \pm 0.1)$  mm

Copper thickness = 35  $\mu$ m

Material FR4 (EP-GC 02 according to DIN 40 802)

LAYOUT / PAD DESIGN (Dimensions in mm)			
CASE CODE	PAD SIZE		
	LL	LB	LEL
0603	2.20	1.00	0.75
0805	3.40	1.30	1.20
1206	4.50	1.80	1.20
1210	4.50	2.80	1.30

#### Note

- LL = total length; LB = width of the pad; LEL = single pad length

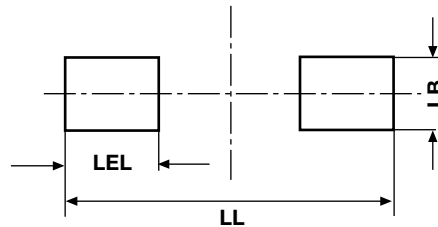

### 6.2 SOLDERING INSTRUCTIONS

THICKNESS, RECOMMENDED FOR SOLDER PASTE (Reflow soldering)	
CASE CODE	THICKNESS in $\mu$ m
0402	75 to 90
0603	150 to 200
0805	150 to 200
1206	150 to 200
1210	150 to 200

### 6.3 TYPICAL TEMPERATURE PROFILE FOR REFLOW SOLDERING (Boardflex test)

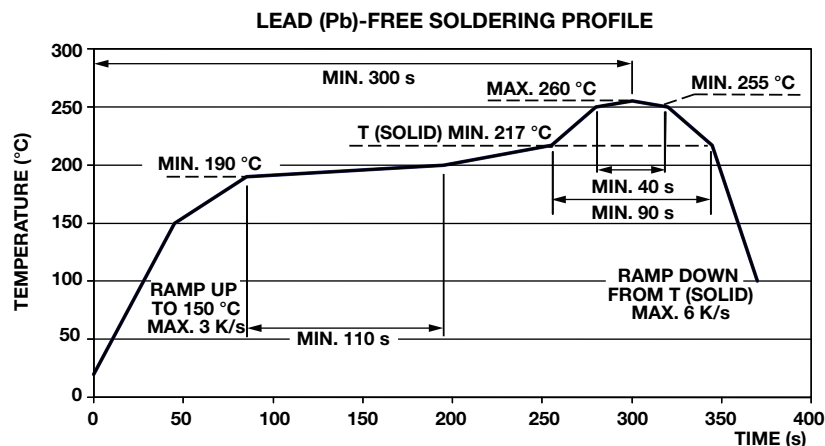

## 6.4 MOUNTING, DIMENSIONS, AND TESTING

### Mounting

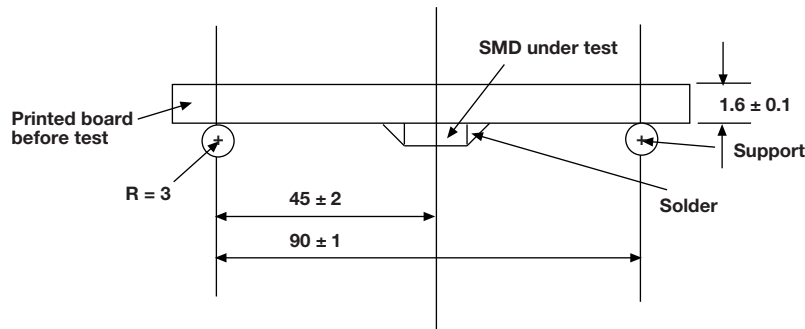

### Testing

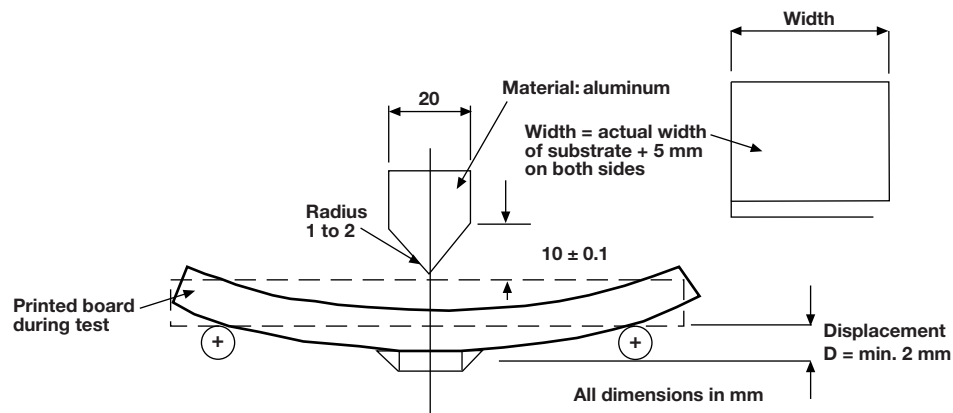

## 6.5 PERFORMANCE OF THE TEST(S)

- Electrical test according to component specification (Cap, DF, IR)
- Mounting to PCB
- Storage at room temperature (min. 10 h)
- Board flex test

## 6.6 DETAILS

X7R	PCB to be deflected continuously, speed 1 mm/s ( $\pm 0.5$ mm/s)
C0G	PCB to be deflected in steps until cracks or other damages are visible or can be measured. Dwell time between steps: $(5 \pm 1)$ s

## 6.7 FAILURE CRITERIA

X7R	Piezoelectric sensor, no failure up to min. 2 mm
C0G (NP0)	$\Delta C/C < 1\%$ or $< 1$ pF, no failure up to min. 2 mm
Both	Electrical test according to component specification

## 7 - QUALIFICATION TESTING

Qualification is performed per the appropriate tests as detailed in the “Stress Qualifications for Ceramic Capacitors” section of the prevailing revision of AEC-Q200 specification.

## Solder Pad Dimensions for Vishay Surface-Mount Multilayer Ceramic Chip Capacitors

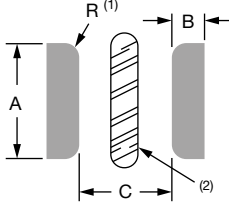
DIMENSIONS in millimeters			
			
CASE CODE	A	B	C
0402	0.50	0.50	0.40
0505	1.35	1.00	0.60
0603	0.90	1.00	1.00 <sup>(3)</sup>
0805	1.30	1.20	1.00
1111	2.90	1.30	1.75
1206	1.80	1.20	2.10
1210	2.80	1.30	1.90
1808	2.40	1.50	3.00
1812	3.60	1.50	3.00
1825	6.50	1.50	3.00
2008	2.70	1.50	4.08
2220	5.50 <sup>(4)</sup>	1.50	4.20
2225	6.50	1.50	4.20
2525	6.60	1.50	4.50
3040	10.80	2.00	5.50
3640	10.80	2.00	7.00
3838	10.20	2.00	7.50
4044	12.30	2.00	8.00

### Notes

- (1) For safety capacitors and voltages above 3000 V, corner rounding (R) of 0.5 mm is recommended to suppress arcing
- (2) Add a 1 mm slot in PCB between pads to allow cleaning and coating under MLCC
- (3) For VJ HiFREQ Series, this dimension is 0.6 mm
- (4) For safety capacitors, the A dimension should be 5.80 mm



## PRINTED CIRCUIT BOARD PCB DESIGN CONSIDERATIONS FOR HIGH VOLTAGE SURFACE-MOUNT MLCCS

Special assembly process and design considerations should be employed for today's high voltage rating MLCCs. As case sizes remain the same and voltage ratings increase, MLCC manufacturers must design, evaluate, and qualify their capacitors using methods that reduce the occurrence of corona discharge and arcover events. To meet similar capability in high voltage applications, users should employ similar cautionary design and assembly methods.

### MLCC PAD LAYOUT

A capacitor's arcover inception point can degrade due to factors such as the MLCC termination, PCB pad design, PCB cleanliness, solder flux residue, surface contamination / deposits and environmental conditions. PCB pads and their design affect the air gap distance between the opposing polarities of the MLCC termination. For voltage rating greater than 1500 V<sub>DC</sub> add a corner radius to the inward facing edge of the MLCC pads and as large a gap as possible between the pads. Too small of a pad gap distance will reduce the capacitor's own arcover inception voltage level. Refer to the Figure and Table Figure 1.0, MLCC Pad Layout and Table 1.0, Vishay MLCC Solder Pad Dimensions for the recommended MLCC solder pad dimensions.

### SLOT OR TRENCH BETWEEN PADS

PCB assembly can deposit dust, trap solder balls, or flux residue underneath the capacitors. These contaminants will reduce conductive clearances and the arcover inception level. Assembly methods must include a final PCB cleaning process. A slot or trench can be cut into the PCB in between the pads to allow cleaners to penetrate underneath the MLCC. The slot will also allow conformal or epoxy coatings to flow underneath the MLCC and build an insulative barrier between pads. Refer to Figure 1.0 MLCC Pad Layout for slot reference location.

### COATING PRINTED CIRCUIT BOARD

Coating a printed circuit board with materials such as acrylic, silicone and urethane resins provide a protective dielectric barrier that is non-conductive and will enhance the resistance to arcing. Various processes exist which include dipping, brushing, and spaying. Optimal performance will come from coating the MLCC on all sides, top and bottom. The PCB slot in between the pads should extend slightly beyond the width of the MLCC. Refer to Figure 1.0 MLCC Pad Layout for slot reference location.



## Disclaimer

ALL PRODUCT, PRODUCT SPECIFICATIONS AND DATA ARE SUBJECT TO CHANGE WITHOUT NOTICE TO IMPROVE RELIABILITY, FUNCTION OR DESIGN OR OTHERWISE.

Vishay Intertechnology, Inc., its affiliates, agents, and employees, and all persons acting on its or their behalf (collectively, "Vishay"), disclaim any and all liability for any errors, inaccuracies or incompleteness contained in any datasheet or in any other disclosure relating to any product.

Vishay makes no warranty, representation or guarantee regarding the suitability of the products for any particular purpose or the continuing production of any product. To the maximum extent permitted by applicable law, Vishay disclaims (i) any and all liability arising out of the application or use of any product, (ii) any and all liability, including without limitation special, consequential or incidental damages, and (iii) any and all implied warranties, including warranties of fitness for particular purpose, non-infringement and merchantability.

Statements regarding the suitability of products for certain types of applications are based on Vishay's knowledge of typical requirements that are often placed on Vishay products in generic applications. Such statements are not binding statements about the suitability of products for a particular application. It is the customer's responsibility to validate that a particular product with the properties described in the product specification is suitable for use in a particular application. Parameters provided in datasheets and / or specifications may vary in different applications and performance may vary over time. All operating parameters, including typical parameters, must be validated for each customer application by the customer's technical experts. Product specifications do not expand or otherwise modify Vishay's terms and conditions of purchase, including but not limited to the warranty expressed therein.

Hyperlinks included in this datasheet may direct users to third-party websites. These links are provided as a convenience and for informational purposes only. Inclusion of these hyperlinks does not constitute an endorsement or an approval by Vishay of any of the products, services or opinions of the corporation, organization or individual associated with the third-party website. Vishay disclaims any and all liability and bears no responsibility for the accuracy, legality or content of the third-party website or for that of subsequent links.

Except as expressly indicated in writing, Vishay products are not designed for use in medical, life-saving, or life-sustaining applications or for any other application in which the failure of the Vishay product could result in personal injury or death. Customers using or selling Vishay products not expressly indicated for use in such applications do so at their own risk. Please contact authorized Vishay personnel to obtain written terms and conditions regarding products designed for such applications.

No license, express or implied, by estoppel or otherwise, to any intellectual property rights is granted by this document or by any conduct of Vishay. Product names and markings noted herein may be trademarks of their respective owners.