



5G

APPLICATIONS

For Diodes
and Rectifiers



5G: THE WAY TO CONNECT EVERYTHING

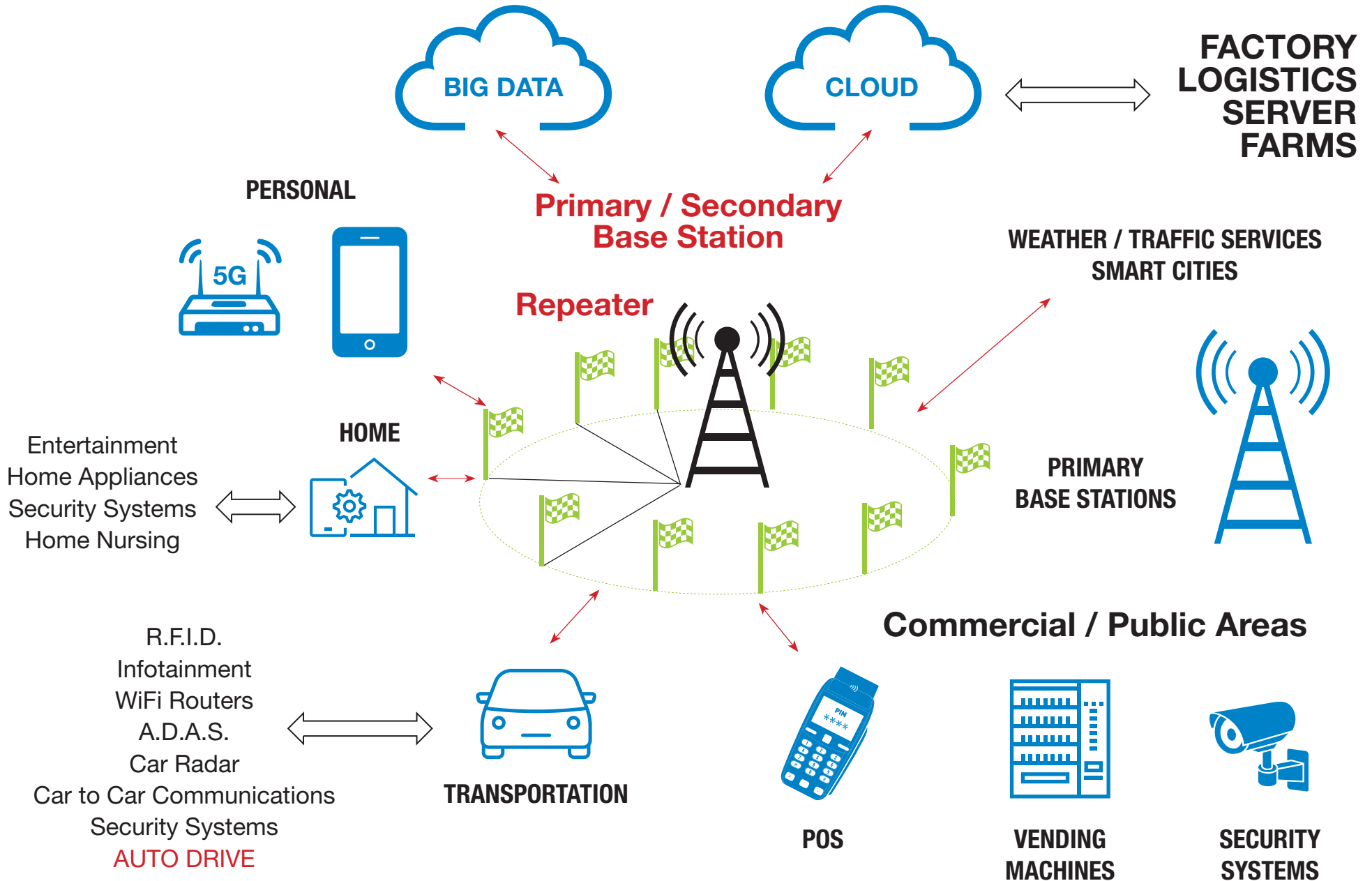

5G APPLICATIONS

Diodes and Rectifiers



5G Base Stations

- 5 System Architecture (diagram)
- 6 High Current Density Bridge Rectifiers
- 7 Rectifiers
- 8 Schottky Rectifiers
- 9 Low Voltage Rectifiers
- 10 Small Signal Switching Diodes
- 10 Small Signal Schottky Diodes
- 10 Small Signal Zener Diodes



Repeaters

- 12 5G Repeaters (diagram)
- 13 Rectifiers / Transient Voltage Suppressors
- 14 Transient Voltage Suppressors
- 15 Schottky Rectifiers

www.vishay.com

For technical questions within your region, please contact: DiodesAmericas@vishay.com, DiodesAsia@vishay.com, DiodesEurope@vishay.com



5G BASE STATIONS

System Architecture (diagram)

High Current Density Bridge Rectifiers

Rectifiers

Schottky Rectifiers

Low Voltage Rectifiers

Small Signal Switching Diodes

Small Signal Schottky Diodes

Small Signal Zener Diodes

SYSTEM ARCHITECTURE

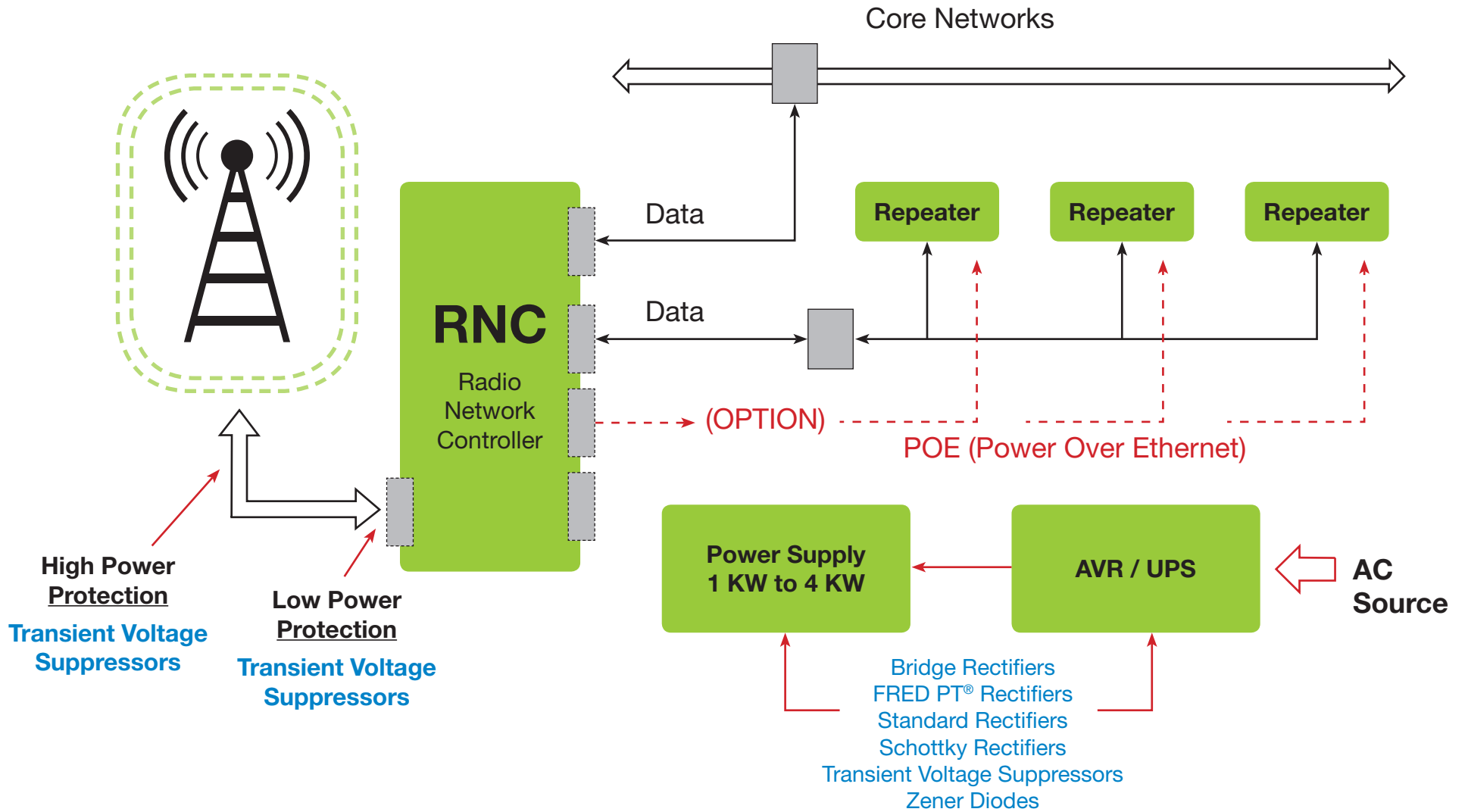



■ High current density bridge rectifiers in compact packages

- Low V_F and high forward surge current capability
- Improves system power efficiency

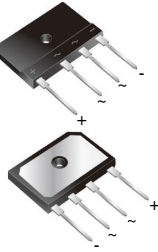
		$I_{F(AV)}$	V_{RRM}	V_F at 125 °C		I_{FSM} at 8.3 ms	Package
	LVB1560	15 A	600 V	0.73 V	7.5 A	400 A	GSIB-5S
	LVE1560	15 A	600 V	0.71 V	7.5 A	300 A	
	LVB2560	25 A	600 V	0.76 V	12.5 A	550 A	
	LVE2560	25 A	600 V	0.74 V	12.5 A	400 A	
	PB3010	30 A	1000 V	0.97 V	15 A	240 A	isoCink+™
	PB3510	35 A	1000 V	0.90 V	17.5 A	350 A	
	PB4010	40 A	1000 V	0.94 V	20 A	400 A	
	PB5010	45 A	1000 V	0.90 V	22.5 A	450 A	



■ Rectifiers in compact packages for auxiliary functions (snubber, clamp, bootstrap, rectifier, etc.)

- Increased power density for space savings
- Improved recovery for better EMC

		$I_{F(AV)}$	V_{RRM}	Package			$I_{F(AV)}$	V_{RRM}	Package
	VS-1EFU06-M3	1 A	600 V	SMF (DO-219AB)		AU1PK	1 A	800 V	SMP (DO-220AA)
	VS-2EFU06-M3	2 A	600 V	SMF (DO-219AB)					
	VS-3EJU06-M3	3 A	600 V	SlimSMA (DO-221AC)		AU2PK	2 A	800 V	SMPC (TO-277A)
						AU3PK	3 A	800 V	SMPC (TO-277A)
	VS-6ESH06-M3	6 A	600 V	SMPC (TO-277A)		AU1PM	1 A	1000 V	SMP (DO-220AA)
							AU2PM	2 A	1000 V
					AU3PM		3 A	1000 V	SMPC (TO-277A)



- Schottky rectifiers in compact packages for sub-power in line cards
 - Increased power density for space savings

		I_F (AV)	V_{RRM}	V_F at I_F (Typ.)	Package
	VSKY20401608	2 A	40 V	0.51 V	CLP1608-2L
	MSS2P3	2 A	30 V	0.52 V	MicroSMP (DO-219AD)
	V3FL45	3 A	45 V	0.50 V	SMF (DO-219AB)
	V3PM6	3 A	60 V	0.55 V	SMP (DO-220AA)
	VSSAF5M6	5 A	60 V	0.58 V	SlimSMA (DO-221AC)
	VSS8D5M6	5 A	60 V	0.58 V	SlimSMAW (DO-221AD)
	V8PAM12	8 A	120 V	0.63 V at 4 A	SMPA (DO-221BC)

		I_F (AV)	V_{RRM}	V_F at I_F (Typ.)	Package
	V25PL60	25 A	60 V	0.46 V at 12.5 A	SMPC (TO-220A)
	V40PWM15C	20 A x 2	150 V	0.97 V at 10 A / diode	SlimDPAK (TO-252AE)
	V35PWM12	35 A	120 V	0.72 V at 17.5 A	
	V60DM120C	30 A x 2	120 V	0.68 V at 15 A / diode	SMPD (TO-263AC)
	V35DM120	35 A	120 V	0.73 V at 17.5 A	
	V30K45	30 A	45 V	0.54 V	FlatPAK 5 X 6



■ Low voltage rectifiers for bridgeless and multiphase bridgeless topologies

- Increased power density for space savings, improved efficiency

		I_F (AV)	V_{RRM}	Package
	VS-6EVL06-M3	6 A	600 V	SlimDPAK (TO-252AE)
	VS-8ETL06-M3	8 A	600 V	2L TO-220AC
	VS-8ETL06FP-N3	8 A	600 V	2L TO-220 FullPAK
	VS-8EVL06-M3	8 A	600 V	SlimDPAK (TO-252AE)
	VS-10CDU06HM3	2 x 5 A	600 V	SMPD (TO-263AC)
	VS-15ETL06-M3	15 A	600 V	2L TO-220AC
	VS-15ETL06FP-N3	15 A	600 V	2L TO-220 FullPAK

		I_F (AV)	V_{RRM}	Package
	VS-15EVL06-M3	15 A	600 V	SlimDPAK (TO-252AE)
	VS-16EDU06-M3	16 A	600 V	SMPD (TO-263AC)
	VS-E4TU2006FP-N3	20 A	600 V	2L TO-220 FullPAK
	VS-ETU3006-M3	30 A	600 V	2L TO-220AC
	VS-30CDU06-M3	2 x 15 A	600 V	SMPD (TO-263AC)
	VS-ETU3006FP-M3	30 A	600 V	2L TO-220 FullPAK





■ Small signal switching diodes in a compact package

		$I_{F(AV)}$	V_{RRM}	t_{rr}	Package
	BAS16WS	0.25 A	100 V	6 ns	SOD-323

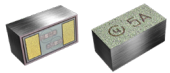
■ Small signal schottky diodes in a compact package

		$I_{F(AV)}$	V_{RRM}	t_{rr}	Package
	BAS40	0.25 A	40 V	1 V at 40 mA	SOT-23
	VSKY02400603	0.20 A	40 V	0.475 V at 200 mA	CLP0603

■ Small signal zener diodes in a compact package

		P_d	V_z range (typ.)	Package
	PLZ Series	500 mW	2.0 V to 39 V	MicroSMF (DO-219AC)
	BZX384C Series	200 mW	2.4 V to 75 V	SOD-323
	BZX584C Series	200 mW	2.4 V to 51 V	SOD-523



5G REPEATERS

5G Repeaters (diagram)

Rectifiers / Transient Voltage Suppressors

Transient Voltage Suppressors



Schottky Rectifiers



■ Rectifiers for high di/dt snubbers in compact packages

		$I_F (AV)$	V_{RRM}	t_{tr}	Package
	VS-1EFU06-M3	1.0 A	600 V	55 ns	SMF (DO-219AB)
	VS-2EFU06-M3	2.0 A	600 V	55 ns	SMF (DO-219AB)
	AU1PK	1.0 A	800 V	75 ns	SMP (DO-220AA)
	AU1PM	1.0 A	1000 V	75 ns	SMP (DO-220AA)



■ 200 W to 600 W TVS for snubbers; low clamping ratios



		P_d	$V_{BR} (typ.)$	V_{WM}	Package
	P2SMA200A	200 W	190 V to 210 V	171 V	SMA (DO-214AC)
	P2SMA220A		209 V to 231 V	185 V	
	P4SMA180A	400 W	171 V to 189 V	154 V	
	P4SMA220A		209 V to 231 V	185 V	
	P6SMB180A	600 W	171 V to 189 V	154 V	SMB (DO-214AA)
	P6SMB200A		190 V to 210 V	171 V	



■ 1500 W to 5000 W TVS with high power density for lightning protection

■ 1500 W / 3000 W TVS with high power density for DC/DC protection

		P_d	V_{BR} (typ.)	V_{WM}	Package
	<u>SMPC54AN</u>	1500 W	63.2 V	54 V	SMPC (TO-277A)
	<u>1.5SMC91CA</u>		91 V	70.1 V	SMC (DO-214AB)
	<u>SMCJ75CA</u>	87.7 V	75 V		
	<u>SMC3K54CA</u>	3000 W	63.2 V	54 V	
	<u>SMC3K70CA</u>		81.9 V	70 V	
	<u>SMC3K75CA</u>	87.7 V	75 V		
	<u>SMC5K54A</u>	5000 W	63.2 V	54 V	
	<u>SMC5K78A</u>		91.3 V	78 V	

		P_d	V_{BR} (typ.)	V_{WM}	Package
	<u>SMCJ15A</u>	1500 W	17.6 V	15 V	SMC (DO-214AB)
	<u>SMCJ24CA</u>		28.1 V	24 V	
	<u>SMCJ33CA</u>		38.7 V	33 V	
	<u>SMCJ36A</u>		42.1 V	36 V	
	<u>1.5SMC39A</u>		39 V	33.3 V	
	<u>TPC24CA</u>		24 V	20.5 V	SMPC (TO-277A)
	<u>TPC36CA</u>		36 V	30.8 V	
	<u>SMC3K24CA</u>	3000 W	28.1 V	24 V	SMC (DO-214AB)



■ Schottky rectifiers in compact packages for auxiliary service and synchronous parallel rectification

		I_F (AV)	V_{RRM}	V_F at I_F (typ.)	Package
	<u>V1FM10</u>	1 A	100 V	0.69 V	SMF (DO-219AB)
	<u>VSKY20401608</u>	2 A	40 V	0.51 V	CLP1608-2L
	<u>V2FM10</u>	2 A	100 V	0.75 V	SMF (DO-219AB)
	<u>MSS2P3</u>	2 A	30 V	0.52 V	MicroSMP (DO-219AD)
	<u>V3FL45</u>	3 A	45 V	0.50 V	SMF (DO-219AB)
	<u>V3PM10</u>	3 A	100 V	0.55 V	SMP (DO-220AA)
	<u>VSSAF5M6</u>	5 A	60 V	0.58 V	SlimSMA (DO-221AC)
	<u>VSS8D5M6</u>	5 A	60 V	0.58 V	SlimSMAW (DO-221AD)

		I_F (AV)	V_{RRM}	V_F at I_F (typ.)	Package
	<u>V8PAM12</u>	8 A	120 V	0.63 V at 4 A	SMPA (DO-221BC)
	<u>V20DM120-M3</u>	20 A	120 V	0.77 V at 10 A	SMPD (TO-263AC)
	<u>V25PL60</u>	25 A	60 V	0.46 V at 12.5 A	SMPC (TO-220A)
	<u>V40PWM15C</u>	20 A x 2	150 V	0.97 V at 10 A / diode	SlimDPAK (TO-252AE)
	<u>V35PWM12</u>	35 A	120 V	0.72 V at 17.5 A	
	<u>V60DM120C</u>	30 A x 2	120 V	0.68 V at 15 A / diode	SMPD (TO-263AC)
	<u>V35DM120</u>	35 A	120 V	0.73 V at 17.5 A	
	<u>V30K45</u>	30 A	45 V	0.54 V	FlatPAK 5 X 6