



# Designing the VCNL36825T Into an Application

By Hakimi Wan Yusof

## INTRODUCTION AND BASIC OPERATION

The VCNL36825T is a fully integrated proximity sensor. It combines a high power VCSEL (vertical-cavity surface-emitting laser) and photodiode for proximity measurement and signal processing IC in a single package with a 12-bit ADC. Because the device comes in a small package, it can provide proximity detection in applications with extremely tight space requirements, such as true wireless stereo (TWS) earphones / earbuds.

With a range of up to 20 cm (7.9"), this stand-alone component greatly simplifies the use and design-in of a proximity sensors in consumer and industrial applications, because no mechanical barriers are required to optically isolate the emitter from the detector. The VCNL36825T features a miniature, surface-mount 2 mm by 1.25 mm package with a low profile of 0.5 mm. The device is designed specifically to meet the low height requirements of TWS, smartphone, mobile phone, digital camera, and tablet PC applications.

Through its standard I<sup>2</sup>C bus serial digital interface, the VCNL36825T allows easy access to a "proximity signal". The programmable interrupt function offers wake-up functionality for the microcontroller when a proximity change occurs, which reduces processing overhead by eliminating the need for continuous polling.

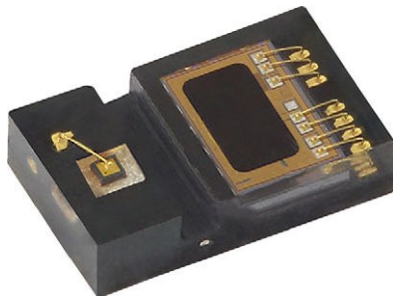

Fig. 1 - VCNL36825T Top View



Fig. 2 - VCNL36825T Bottom View

## COMPONENTS (BLOCK DIAGRAM)

The major components of the VCNL36825T are shown in the block diagram.

In addition to the ASIC with the proximity photodiode, the VCSEL emitter is also implemented. Its cathode is connected to the driver internally and does not need to be connected externally. The anode of the VCSEL is connected to the V<sub>DD</sub> through internal wiring.

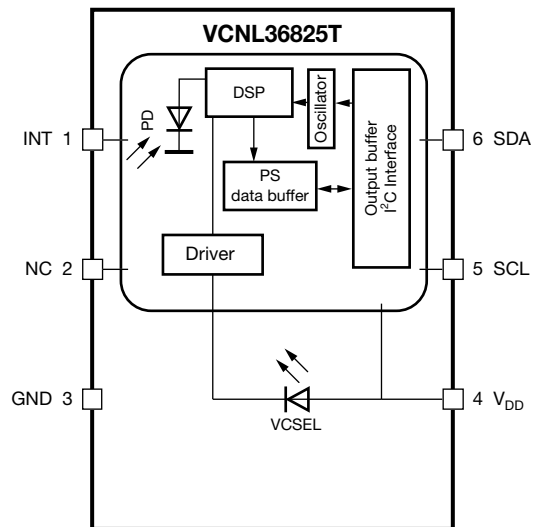

Fig. 3 - VCNL36825T Detailed Block Diagram

The DNA of tech.™

## Designing the VCNL36825T Into an Application

The integrated VCSEL emitter has a peak wavelength of 940 nm. It emits light that reflects off an object within 20 cm of the sensor. The VCSEL emitter has a narrow emission angle of approximately  $\pm 4^\circ$ , as shown in Fig. 4.

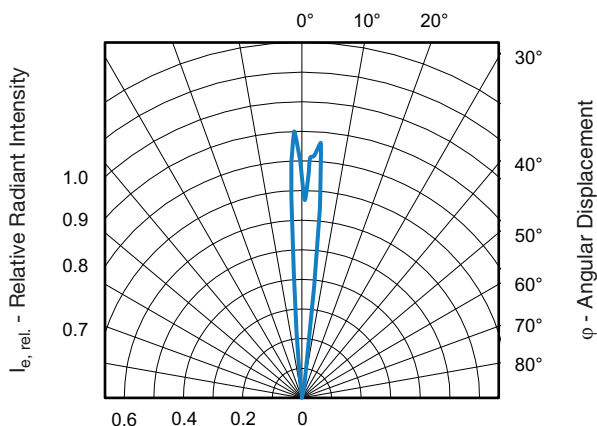

Fig. 4 - Angle of Half Intensity of the Emitter

The VCSEL emitter has a programmable drive current from 10 mA to 20 mA in six steps. The infrared light is emitted in short pulses with a programmable period time from 10 ms to 80 ms. The proximity photodiode receives the light that is reflected off the object and converts it to a current. The sensitivity of the proximity stage is also programmable by choosing from four different integration times. It is insensitive to ambient light. It ignores the DC component of light and “looks for” the pulsed light at the proximity frequency used by the emitter.

The application-specific integrated circuit, or ASIC, includes a current driver, I<sup>2</sup>C bus interface, amplifier, integrated analog-to-digital converter, oscillator, and Vishay’s “secret sauce” signal processor. For proximity, it converts the current from the photodiode to a 12-bit digital data output value.

### PIN CONNECTIONS

Fig. 3 shows the pin assignments of the VCNL36825T.

The connections include:

- Pin 1 - INT to microcontroller
- Pin 2 - NC (can be connected to GND)
- Pin 3 - connect to ground
- Pin 4 - V<sub>DD</sub> to the power supply
- Pin 5 - SCL to microcontroller
- Pin 6 - SDA to microcontroller

The power supply for the ASIC (V<sub>DD</sub>) has a defined range from 2.64 V to 3.6 V. The VCSEL is connected to the same power supply through internal wiring. The values depend on the required current, as detailed in the product datasheet.

One ceramic 1  $\mu$ F capacitor should be placed close to the V<sub>DD</sub> (pin 4) for decoupling purposes. The SCL and SDA, as well as the interrupt lines, need pull-up resistors. The resistor values depend on the application and on the I<sup>2</sup>C bus speed. Common values are about 2.2 k $\Omega$  to 4.7 k $\Omega$  for the SDA and SCL, and about 8.2 k $\Omega$  to 22 k $\Omega$  for the interrupt lines.

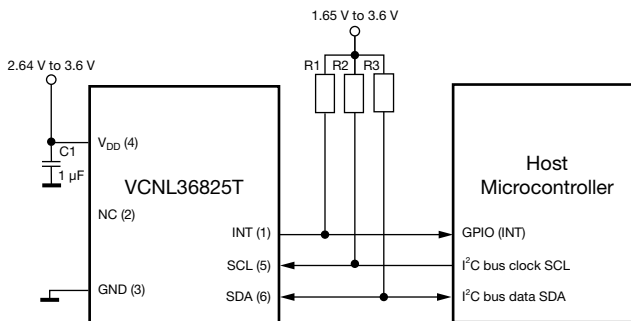

Fig. 5 - VCNL36825T Application Circuit

The DNA of tech.™

## Designing the VCNL36825T Into an Application

### MECHANICAL DESIGN CONSIDERATIONS

The VCNL36825T does not require a mechanical barrier. The signal processor continuously compensates for the light reflected from windows, thus ensuring a proper proximity reading. As a fully integrated sensor, the design process is greatly simplified.

The only dimensions that the design engineer needs to consider are the distance from the top surface of the sensor to the outside surface of the window, and the size of the window. These dimensions will determine the size of the detection zone.

The angle of half intensity of the emitter is about  $\pm 4^\circ$ , as shown in Fig. 6, and the sensitivity of the photodiode depends on the axis of the sensor. The horizontal axis has a  $\pm 45^\circ$  relative sensitivity whereas the vertical axis has a  $\pm 60^\circ$  relative sensitivity, as shown in Fig. 7.



Fig. 8 - Field of View of Photodiode Horizontal (left) and Vertical (right)

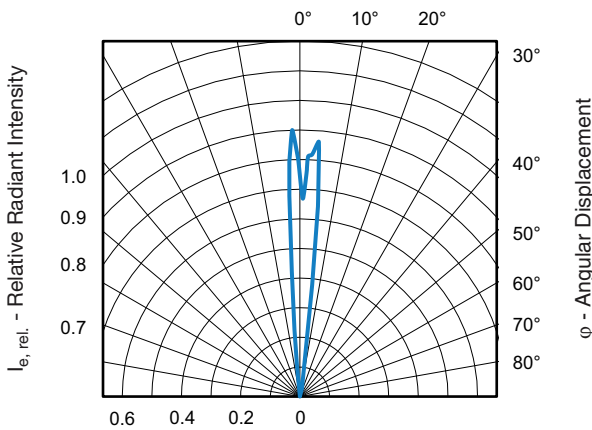

Fig. 6 - Angle of the Half Intensity of the Emitter

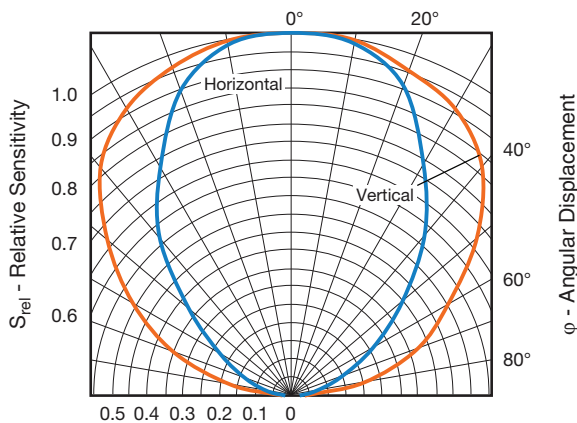

Fig. 7 - Angle of the Half Sensitivity of the Photodiode

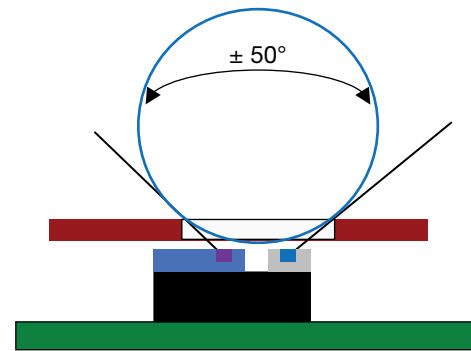

Fig. 9 - Emitter and Detector Angle

The detector has a different field of view between the axes. The horizontal axis has a  $\pm 45^\circ$  relative sensitivity whereas the vertical axis has a  $\pm 60^\circ$  relative sensitivity. Since the vertical axis has a bigger field of view, it is the limiting factor when designing the hole for the cover glass.

To achieve good performance, the diameter of the hole within the cover glass should not be too small. An angle of  $\pm 50^\circ$  will be sufficient in most applications. The package drawing shows the position of the VCSEL and photosensitive area. The  $\pm 50^\circ$  lines are set to outer edges of the photodiode and VCSEL. The following are dimensions for the distance from the top surface of the sensor to the outside surface of the glass,  $a$ , and the width of the window,  $d$ .

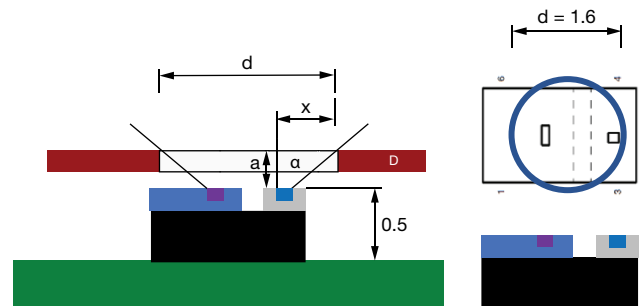

Fig. 10 - Window Dimensions for One Hole

The DNA of tech.™

## Designing the VCNL36825T Into an Application

For a single round hole, the diameter should be at least wide enough that the openings can freely look through; so, about 1.6 mm.

The diameter needs to be increased with distances between the sensor and cover glass according to the following calculation.

The width calculation for distances from 0 mm to 1.5 mm results in:

$a = 0.0 \text{ mm} \rightarrow x = 0.00 \rightarrow d = 1.6 \text{ mm} + 0.00 = 1.60 \text{ mm}$   
 $a = 0.5 \text{ mm} \rightarrow x = 0.60 \rightarrow d = 1.6 \text{ mm} + 1.20 = 2.80 \text{ mm}$   
 $a = 1.0 \text{ mm} \rightarrow x = 1.19 \rightarrow d = 1.6 \text{ mm} + 2.38 = 3.98 \text{ mm}$   
 $a = 1.5 \text{ mm} \rightarrow x = 1.79 \rightarrow d = 1.6 \text{ mm} + 3.58 = 5.18 \text{ mm}$

Calculation is:  $\tan \alpha = x/a \rightarrow$  with  $\alpha = 50^\circ$  and  $\tan 50^\circ = 1.19 = x/a \rightarrow x = 1.19 \times a$ . Then total width / diameter for the opening is  $d = 1.6 \text{ mm} + 2 \times x$ .

The results above represent the ideal diameters of the window. The mechanical design of the device may not allow for these diameters. Fig. 10 shows that also a smaller opening could be used. To allow for this, the gap between sensor and cover should be as small as possible ( $\leq 0.2 \text{ mm}$ ) and the cover also quite thin ( $\leq 0.6 \text{ mm}$ ).

### PROXIMITY SENSOR

The main DC light sources found in the environment are sunlight and tungsten (incandescent) bulbs. These kinds of disturbance sources will cause a DC current in the detector inside the sensor, which in turn will produce noise in the receiver circuit. The negative influence of this DC light can be reduced by optical filtering, but is reduced much more efficiently by a so-called DC kill function. The proximity photodiode shows its best sensitivity at about 850 nm, as shown in Fig. 11.

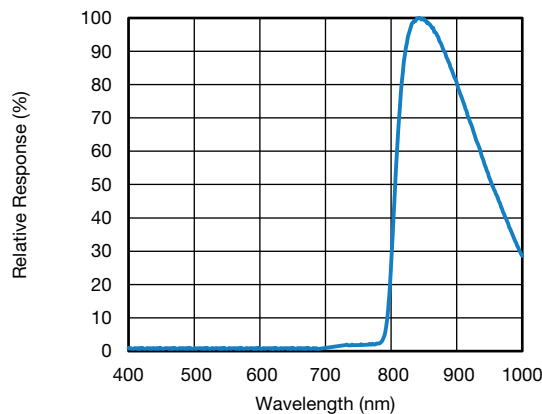

Fig. 11 - Spectral Sensitivity of the Proximity Photodiode

The proximity sensor uses a short pulse signal of about 50  $\mu\text{s}$  ( $\text{PS\_IT} = 1\text{T}$ ) up to 400  $\mu\text{s}$  ( $\text{PS\_IT} = 8\text{T}$ ).  $\text{PS\_ITB}$  sets the duration of T in  $\text{PS\_IT}$ . It is recommended to set  $\text{PS\_ITB}$  to 50  $\mu\text{s}$  because it improves the sensitivity and sunlight protection of the sensor. The period time for this single pulse can be programmed between 10 ms and 80 ms.

In addition to DC light source noise, there is some reflection of the infrared emitted light off the surfaces of the components surrounding the VCNL36825T. The distance to the cover, proximity of surrounding components, tolerances of the sensor, defined infrared emitter current, ambient temperature, and type of window material used all contribute to this reflection. The result of the reflection and DC noise are the production of an output current on the proximity and light sensing photodiode. This current is converted into a count called the offset count.

In addition to the offset count, there could also be a small noise floor during the proximity measurement, which comes from the DC light suppression circuitry. This noise is typically just one or two counts. Only with light sources with strong infrared content could it be in the range from  $\pm 5$  counts to  $\pm 10$  counts.

The application should “ignore” this offset and small noise floor by subtracting them from the total proximity readings. The VCNL36825T offers a subtraction feature that automatically does this:  $\text{PS\_CANC}$ . During the development of the end product, this offset count is evaluated and may now be written into register 7:  $\text{PS\_CANC\_L/H}$ . Now the proximity output data will just show the subtraction result of proximity counts - offset counts.

Results most often do not need to be averaged. If an object with very low reflectivity or at longer range needs to be detected, the sensor provides a register where the customer can define the number of consecutive measurements that the signal must exceed before producing an interrupt. This provides stable results without requiring averaging.

The DNA of tech.™

## Designing the VCNL36825T Into an Application

### PROXIMITY CURRENT CONSUMPTION

The VCNL36825T is in shutdown by default. It can be initialized by setting PS\_ON = 1 and PS\_CAL = 1. When the sensor has been initialized, 200 μA current will always be consumed in the sensor. A measurement can be started by setting PS\_ST = 0. The current consumed due to the measurement depends on the settings of the sensor like PS\_IT, I\_VCSEL, PS\_PERIOD, and PS\_MPS.

The VCNL36825T's embedded current driver drives the internal VCSEL with a pulsed duty cycle. The VCSEL pulsed duty cycle is programmable by an I<sup>2</sup>C command in register PS\_PERIOD with choices between 10 ms and 80 ms. Depending on this measurement period, the overall proximity current consumption can be calculated. When higher measurement speed or faster response time is needed, PS\_PERIOD may be selected to a short time of 10 ms, but this will then also lead to the highest current consumption. If lower power consumption is needed, slower proximity measurements can be executed every 80 ms. The current consumption for the self-timed mode can be calculated as follows:

Current consumption = supply current + measurement current

$$= 200 \mu\text{A} + \left( \frac{(230 \mu\text{A} \times (900 \mu\text{s} + (2 \times \text{PS\_IT}))) + (I_{\text{VCSEL}} \times \text{PS\_IT})}{\text{PS\_PERIOD}} \right)$$

Where,

$$\text{Measurement current} = \left( \frac{(230 \mu\text{A} \times (900 \mu\text{s} + (2 \times \text{PS\_IT}))) + (I_{\text{VCSEL}} \times \text{PS\_IT})}{\text{PS\_PERIOD}} \right)$$

Example 1:

PS\_IT = 1T = 50 μs, I\_VCSEL = 20 mA, PS\_PERIOD = 10 ms and PS\_MPS = 1

$$\text{Current consumption} = 200 \mu\text{A} + \left( \frac{(230 \mu\text{A} \times (900 \mu\text{s} + (2 \times 50 \mu\text{s}))) + (20 \text{ mA} \times 50 \mu\text{s})}{10 \text{ ms}} \right) = 302.32 \mu\text{A}$$

Example 2:

PS\_IT = 1T = 50 μs, I\_VCSEL = 20 mA, PS\_PERIOD = 80 ms and PS\_MPS = 1

$$\text{Current consumption} = 200 \mu\text{A} + \left( \frac{(230 \mu\text{A} \times (900 \mu\text{s} + (2 \times 50 \mu\text{s}))) + (20 \text{ mA} \times 50 \mu\text{s})}{80 \text{ ms}} \right) = 212.79 \mu\text{A}$$

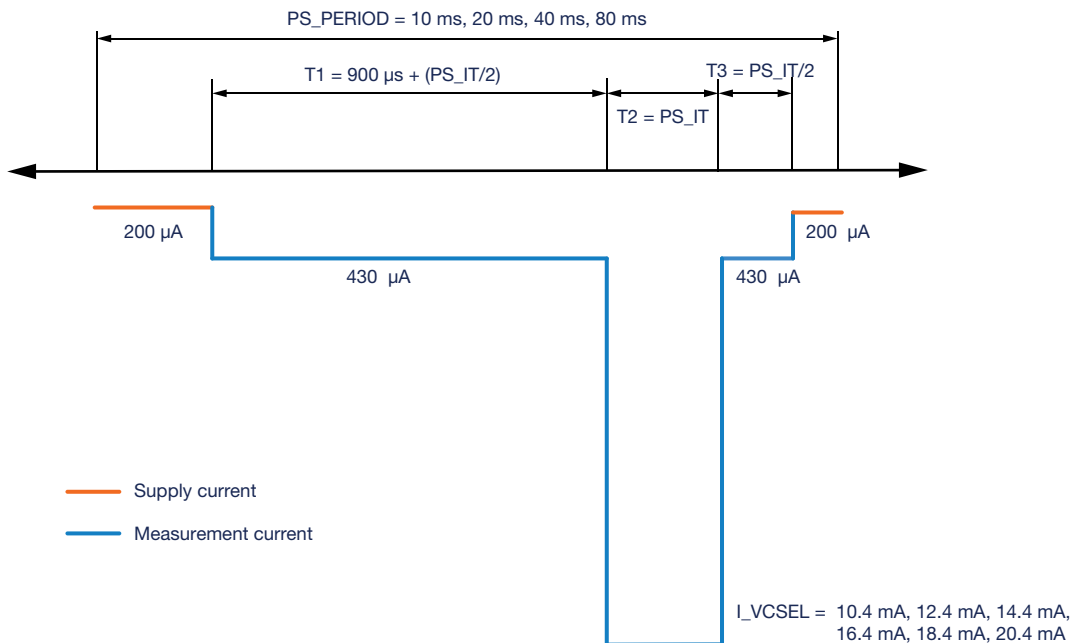

Fig. 12 - Current Consumption Diagram for the Self-Timed Mode



The DNA of tech.™

## Designing the VCNL36825T Into an Application

Another way to execute proximity measurements is to apply a PS active force mode (register: PS\_CONF3\_L, command: PS\_AF = 1).

If only a single proximity measurement needs to be done, PS\_AF is set to “1” and then PS\_ST = 0 = active. Setting PS\_TRIG = 1 will then execute just one single measurement.

In this mode, only the I<sup>2</sup>C interface is active. In most consumer electronic applications the sensor will spend the majority of time in sleep mode; it only needs to be woken up for a proximity measurement.

This “active force” mode may be used for even faster measurements than are possible with the self-timed mode. If lowest possible power consumption is needed, the device should be switched off with 1. PS\_ST = 1 and 2. PS\_ON = 0 after every measurement.

### “LOW POWER CONSUMPTION” MODE

With register PS\_LPEN set to 1, the proximity sensor operates in a special low power consumption mode offering significant lower power consumption.

This is a remarkable feature for any application requiring lower power consumption and one do not want to always request one proximity measurement with proximity force mode: PS\_AF and PS\_TRIG.

The proximity period within this mode is possible to set between 40 ms and 320 ms, means, 25 measurements down to just 3 measurements per second can be programmed.

The current consumption for the low power mode can be calculated as follows:

Current consumption = standby current + measurement current

$$= 5 \mu\text{A} + \left( \frac{(200 \mu\text{A} \times (900 \mu\text{s} + (2 \times \text{PS\_IT}))) + (\text{I\_VCSEL} \times \text{PS\_IT})}{\text{PS\_PERIOD}} \right)$$

Where,

$$\text{Measurement current} = \left( \frac{(200 \mu\text{A} \times (900 \mu\text{s} + (2 \times \text{PS\_IT}))) + (\text{I\_VCSEL} \times \text{PS\_IT})}{\text{PS\_PERIOD}} \right)$$

Example 1:

PS\_IT = 1T = 50 μs, I\_VCSEL = 10mA, PS\_PERIOD = 320 ms and PS\_MPS = 1

$$\text{Current consumption} = 5 \mu\text{A} + \left( \frac{(200 \mu\text{A} \times (900 \mu\text{s} + (2 \times 50 \mu\text{s}))) + (10 \text{ mA} \times 50 \mu\text{s})}{320 \text{ ms}} \right) = 6.63 \mu\text{A}$$

Example 2:

PS\_IT = 1T = 50 μs, I\_VCSEL = 10mA, PS\_PERIOD = 40 ms and PS\_MPS = 1

$$\text{Current consumption} = 5 \mu\text{A} + \left( \frac{(200 \mu\text{A} \times (900 \mu\text{s} + (2 \times 50 \mu\text{s}))) + (10 \text{ mA} \times 50 \mu\text{s})}{40 \text{ ms}} \right) = 18.00 \mu\text{A}$$



The DNA of tech.™

## Designing the VCNL36825T Into an Application

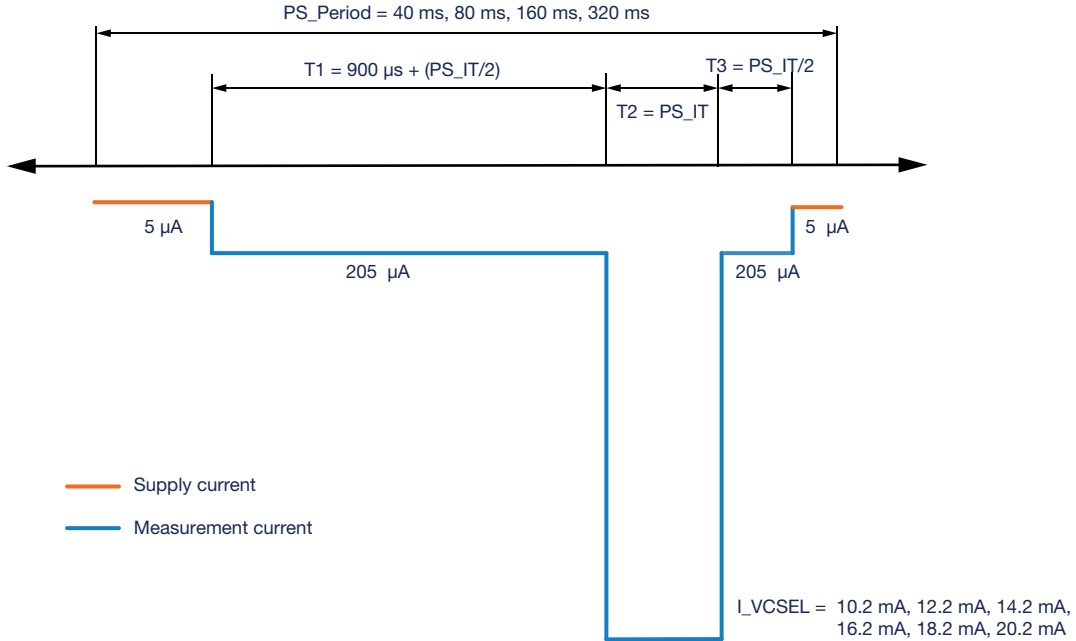

Fig. 13 - Current Consumption Diagram for the Low Power Mode

PS period (ms)	10	20	40	80	160	320
Self-timed mode (μA)	252.32	226.16	213.08	206.54	n/a	n/a
Low power mode (μA)	n/a	n/a	18.00	11.50	8.25	6.63

**Note**

- I\_VCSEL = 10 mA; PS\_IT = 1T

The DNA of tech.™

## Designing the VCNL36825T Into an Application

With PS\_LPEN = 1 = enabled, proximity low power measurements will start. In this case values programmed to PS\_LPPER will be used as period. I\_VCSEL, PS\_IT, PS\_ITB and PS\_MPS will be used as defined within register 3 and register 4.

TABLE 12 - REGISTER: PS_CONF4_H DESCRIPTION											
COMMAND CODE: 0x08_H (0x08 DATA BYTE HIGH)											
Register	Bit	Description									
Reserved	15 : 11	Default = (0 : 0 : 0 : 0 : 0)									
PS_LPPER	10 : 9	(0 : 0) = 40 ms, (0 : 1) = 80 ms, (1 : 0) = 160 ms, (1 : 1) = 320 ms; PS detection period setting at low power mode (PS_LPEN = 1)									
PS_LPEN	8	0 = disable, 1 = enable = starts proximity low power measurements; now PS_LPPER used as period, but I_VCSEL, PS_IT, PS_ITB, PS_MPS as defined within register 3 and register 4									
		PS_IT = 1T = 50 μs; PS_LPPER period (ms)						PS_IT = 8T = 400 μs; PS_LPPER period (ms)			
I_VCSEL (mA)	40	80	160	320	I_VCSEL (mA)	40	80	160	320		
10	18.00	11.50	8.25	6.63	10	109.00	57.00	31.00	18.00		
12	20.50	12.75	8.88	6.91	12	129.00	67.00	36.00	20.50		
14	23.00	14.00	9.50	7.22	14	149.00	77.00	41.00	23.00		
16	25.50	15.25	10.13	7.53	16	169.00	87.00	46.00	25.50		
18	28.00	16.50	10.75	7.84	18	189.00	97.00	51.00	28.00		
20	30.50	17.75	11.38	8.16	20	209.00	107.00	56.00	30.50		

With low power mode applied, VCNL36825T current consumption reaches a minimum level of about 6.6 μA with longest response time of 320 ms, lowest VCSEL current of 10 mA, and shortest integration time of PS\_IT = 50 μs.

A maximum of 209 μA is seen when using with the fast response time of 40 ms, highest VCSEL current of 20 mA, and longest integration time of PS\_IT = 400 μs.

The pulse length of PS\_IT = 1T is 50 μs. The amplitude of that 50 μs pulse is dependent on the VCSEL current. The higher this current is programmed, the higher that pulse amplitude will be. Taking a scope picture with added series resistor within power supply line will look like this:



Fig. 14 - Proximity VCSEL Pulse for 1T

APPLICATION NOTE



The DNA of tech.™

## Designing the VCNL36825T Into an Application

### INITIALIZATION AND I<sup>2</sup>C TIMINGS

The VCNL36825T contains eleven 16-bit command codes for operation control, parameter setup, and result buffering. All registers are accessible via I<sup>2</sup>C communication. The built-in I<sup>2</sup>C interface is compatible with the standard and high speed I<sup>2</sup>C modes. The I<sup>2</sup>C H-level voltage range is from 1.65 V to 3.6 V.

There are only four registers out of the eleven that typically need to be defined:

1. I\_VCSEL = 10 mA to 20 mA (VCSEL current), and PS\_HD = 12 bit / 16 bit (PS output) <sup>(1)</sup>  
REGISTER PS\_CONF3\_H #04 [0x04h]

**Note**

- (1) 16 bit can be used to increase dynamic range but can not be used with threshold interrupt, which limited to 12 bit.
2. PS\_PERIOD = 10 ms to 80 ms (measurement period), PS\_IT (proximity integration time = pulse length), PS\_ITB = 50 μs (IT Bank setting of 50 μs recommended for better sensitivity).  
PS\_PERS (number of consecutive measurements above / below threshold), and PS\_ST (PS start)  
REGISTER PS\_CONF2\_L and PS\_CONF2\_H #03 [0x03h]
3. and 4. Definition of the threshold value from the number of counts the detection of an object should be signaled. This is limited to 12 bit PS output only. Therefore, threshold with interrupt cannot be used with 16 bit PS output. Proximity TOP Threshold REGISTER PS\_THDL\_L #05 [0x05h] for the low byte and PS\_THDL\_H #06 [0x06h] for the high byte.

To define the VCSEL current, as well as the integration time (length of the proximity pulsing), evaluation tests should be performed using the least reflective material at the maximum distance specified.

Fig. 15 shows the typical digital counts output versus distance for three different emitter currents for integration time 1T. The reflective reference medium is the Kodak Gray card. This card shows approximately 18 % reflectivity at 940 nm. Note that the component has an internal offset, which is effected by both the VCSEL driving current and integration time. This offset has been subtracted from the distance curves, such that these show “delta counts” i.e. the change in counts with relation to an object in front of the sensor.

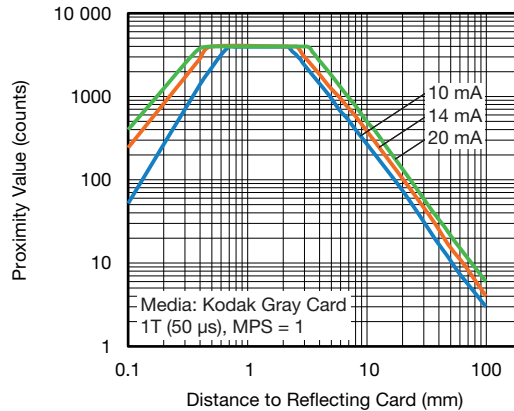

Fig. 15 - Proximity Value vs. Distance for 1T

This first diagram shows the possible detection counts with a short pulse of just 50 μs.

If higher detection distances and / or objects with very low reflectivity need to be detected, there is the option to extend these proximity pulses up to about 400 μs for 8T. This results in higher counts but may also lead to saturation effects for very close and very reflective objects. This leads then to the diagram in Fig. 16 below.

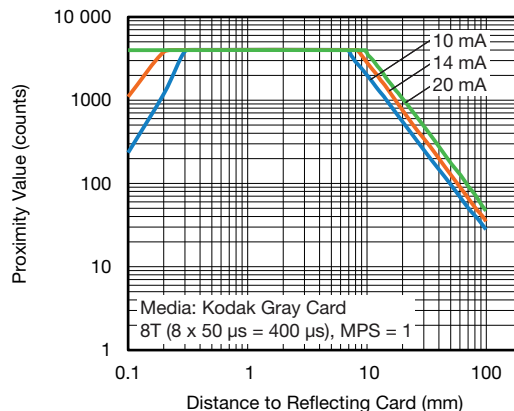

Fig. 16 - Proximity Value vs. Distance; PS\_IT = 8T

The above two graphs do not show the peak sensitivity, as the output counts saturate with the given measurement setup. An additional measurement was performed as shown in Fig.17, with the setting PS\_ITB = 25 μs, to decrease the sensitivity further, in order to make the peak visible. Knowing the peak position is beneficial for cover glass placement.

The DNA of tech.™

## Designing the VCNL36825T Into an Application

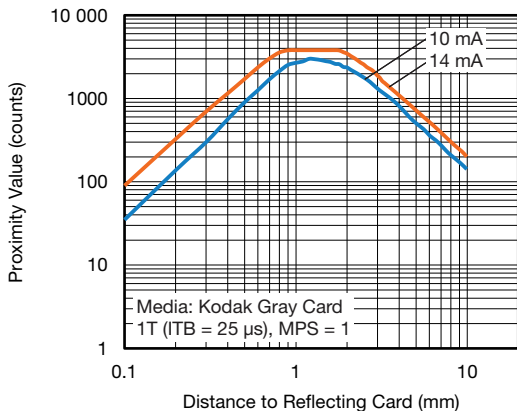

Fig. 17 - Peak Sensitivity of VCNL36825T

The peak sensitivity of VCNL36825T is seen to be at approximately 1.2 mm away from the top of the sensor. As mentioned earlier, one has to be aware of the peak sensitivity of the sensor when designing the window cover above the sensor. By placing the window cover at a distance near the peak sensitivity of around 1.2 mm, it will increase the offset count and the susceptibility to changes in the counts due to scratches and dirt on the cover glass. Optimal placement would be left of the peak (closer to the component). This decreases the offset counts allowing for a higher dynamic range and reduces the reaction to changes on the surface of the cover. As stated before, the offset counts should always be subtracted from active measurements so it is always the change in counts being interpreted by the application.

With the period time (PS\_PERIOD), the repetition rate = the number of proximity measurements per second (speed of proximity measurements) is defined. This is possible between 10 ms (about 90 measurements/s) and 80 ms (about 12 measurements/s).

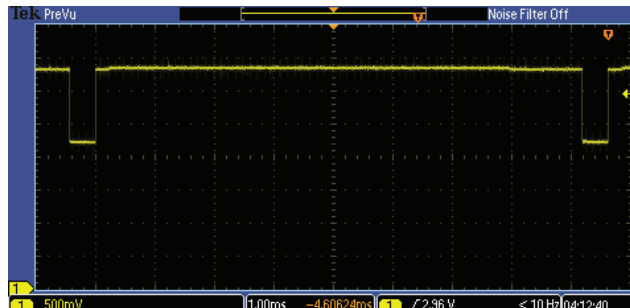

Fig. 18 - Proximity Measurements With PS\_PERIOD = 10 ms

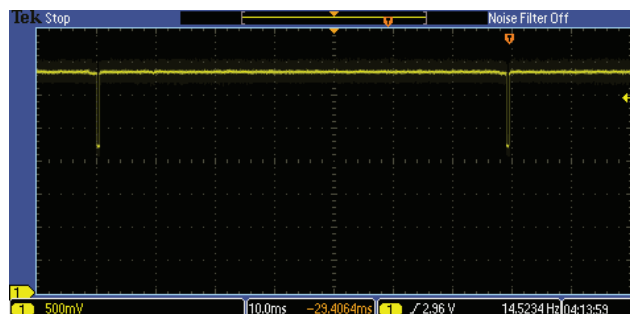

Fig. 19 - Proximity Measurements With PS\_PERIOD = 80 ms

This measurement period also determines how fast the application reacts when an object appears in, or is removed from, the proximity zone.

Reaction time is also determined by the number of counts that must be exceeded before an interrupt is set. This is possible to define with proximity persist: PS\_PERS. Possible values are from 1 to 4.

To eliminate disturbance by direct sunlight these “sunlight cancellation” bits PS\_SC need to be set.

To define all these register values, an evaluation test should be performed. These tests can be made just using the VCNL36825T sensor board together with the SensorXplorer™. Both boards are available from any of Vishay’s distributors. Please see:

[www.vishay.com/optoelectronics/SensorXplorer](http://www.vishay.com/optoelectronics/SensorXplorer).

The DNA of tech.™

## Designing the VCNL36825T Into an Application

### Timing

For an I<sup>2</sup>C bus operating at 100 kHz, to write or read an 8-bit byte, plus start (or stop) and bit acknowledgement, takes 100 μs. Together with the slave address byte and the 8-bit command code byte, plus the 16-bit data, this results in a total of 400 μs. When the device is powered on, the initialization with just these five registers needs 5 x 4 bytes (slave address, command register, and 16-bit data) for a total of 20 bytes. So, 20 x 100 μs = 2000 μs = 2 ms.

Send Byte → Write Command to VCNL36825T

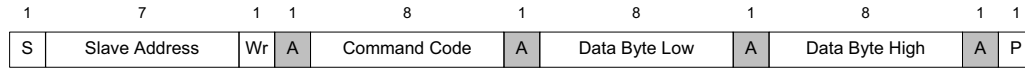

The read-out of 16-bit data would take a total of five bytes (slave address, command code, slave address with read bit set) and 16-bit data sent from the VCNL36825T. So, 500 μs:

Receive Byte → Read Data from VCNL36825T

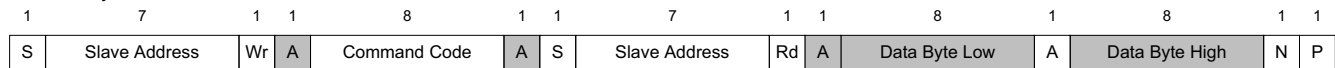

### Power Up

The release of the internal reset, the start of the oscillator, and the signal processor need **2.5 ms**

### Initialize Registers

Write to four registers **1600 μs**

- VCSEL current
- Measurement period
- Proximity interrupt TOP threshold

Once the device is powered on and the VCNL36825T is initialized, a proximity measurement can be taken.

Asking for one forced proximity measurement **400 μs**

For (active forced, PS\_IT = 8)

Time to trigger [0.5 x PS\_IT] **200 μs**

DC-kill ambient light [3 x PS\_IT] **1200 μs**

Proximity measurement [1 x PS\_IT] **400 μs**

VCSEL shutdown [1 x PS\_IT] **400 μs**

Read out of the proximity data **500 μs**

total: **3100 μs**

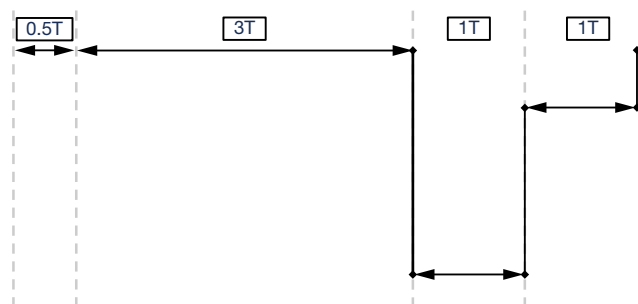

Fig. 20 - Timing Specification for Active Forced Mode

### INITIALIZATION STEPS

It is recommended to follow the following initialization steps to start the most basic proximity measurements using most important parameters:

1. Do the reset using recommended default values (so that the register will start with default values and will not affect the setting of the sensor)

PS\_CONF1\_L = 0x01  
PS\_CONF1\_H = 0x00  
PS\_CONF2\_L = 0x00  
PS\_CONF2\_H = 0x00  
PS\_CONF3\_L = 0x00  
PS\_CONF3\_H = 0x00

... the rest = follow the default value like in the datasheet page 8. Only do for registers that can do R/W only

2. Initialization and measurement steps:

Initialization and use of proximity function

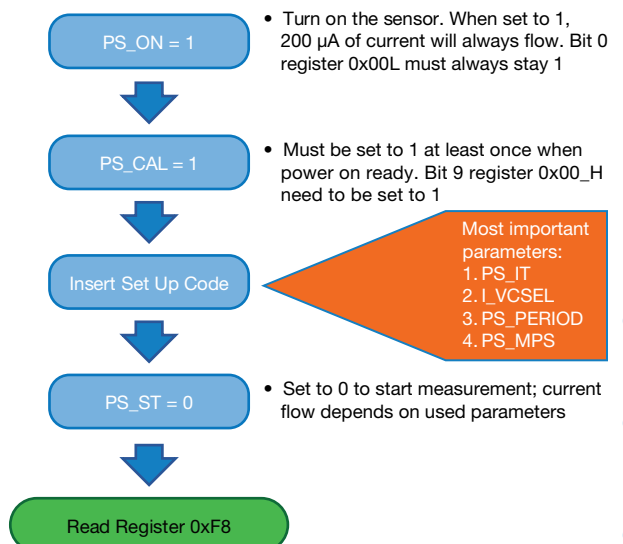

The DNA of tech.™

## Designing the VCNL36825T Into an Application

### INTERRUPT

The VCNL36825T features a very intelligent interrupt function. The interrupt function enables the sensor to work independently until a predefined proximity event or threshold occurs. It then sets an interrupt which requires the microcontroller to awaken. This helps customers reduce their software effort, and reduces power consumption by eliminating polling communication traffic between the sensor and microcontroller.

The interrupt pin, pin 1, of the VCNL36825T should be connected to a dedicated GPIO of the controller. A pull-up resistor is added to the same power supply that the controller is connected to. This INT pull-up resistor may be in the range of 8.2 kΩ to 22 kΩ.

The events that can generate an interrupt include:

1. A lower and an upper threshold for the proximity value can be defined. If the proximity value falls below the lower limit or exceeds the upper limit, an interrupt event will be generated. In this case, an interrupt flag bit in the read-out register 0xF9 will be set and the interrupt pad of the VCNL will be pulled to low by an open drain pull-down circuit. In order to eliminate false triggering of the interrupt by noise or disturbances, it is possible to define the number of consecutive measurements that have to occur before the interrupt is triggered
2. A too high infrared level, which could be caused by strong direct sunlight or a nearby halogen / incandescent lamp, can be observed with checking the bit: PS\_SPFLAG

### Application Example

The following example will demonstrate the ease of using the VCNL36825T sensor.

#### Offset

During development, the application-specific offset counts for the sensor were determined. As previously mentioned, the offset count is affected by the components surrounding the VCNL36825T, the window or cover being used, the distance from the sensor to the cover, and emitter intensity, which is controlled by the forward current.

In the following example, with a cover over the sensor and setting the emitter current to 20 mA and with PS\_MPS = 8 pulses, the offset counts are 300 counts (Fig. 21). Offset counts vary by application and can be anywhere from 0 counts to several hundred counts. It is important to note that the offset count may change slightly over time due to, for example, the window becoming scratched or dirty, or being exposed to high temperature changes. If possible, the offset value should occasionally be checked and, if necessary, modified.

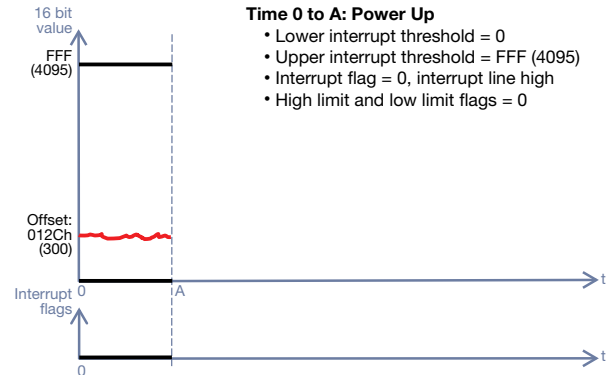

Fig. 21

### Power Up

As mentioned, there are four variables for proximity measurement that need to be set in the register when the sensor is powered up: the emitter current, the number of occurrences that must exceed a threshold to generate an interrupt, the threshold values, and the number of proximity measurements per second.

The sensor should detect skin at a distance of 5 cm. Development testing determined that a current of 20 mA produces adequate counts for detection. The proximity measurement rate is set so that about 14 measurements are done within a second and the number of occurrences to trigger an interrupt is set to four. Based on development testing, with a hand or skin approximately 5 cm above the window cover, the resulting total count is > 500. This will be used as the upper threshold (high threshold).

For smartphone applications it would be typical to initially set this top threshold and a lower threshold (bottom threshold). This is needed to indicate the removal of the phone from the user's ear. The measured counts without any additional object close by will be around this offset count value, always below the lower threshold value, as shown in Fig. 22.

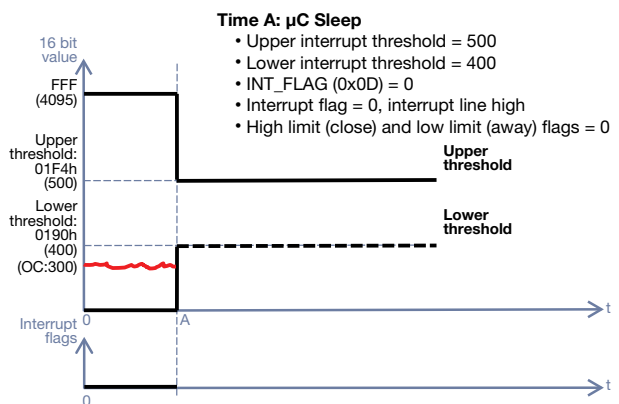

Fig. 22

The DNA of tech.™

## Designing the VCNL36825T Into an Application

By setting the number of occurrences before generating an interrupt to 4, a single proximity value above or below the thresholds will have no effect, as shown in Fig. 23.

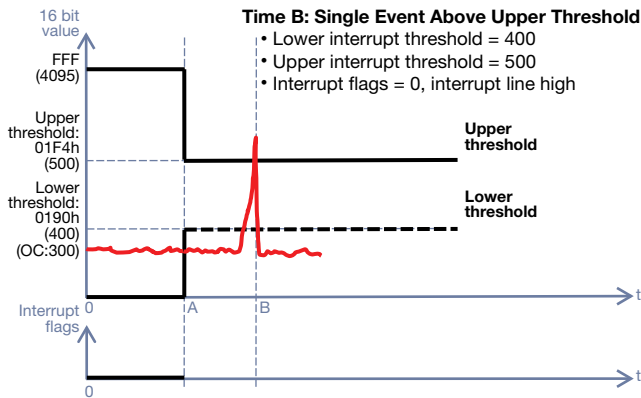

Fig. 23

A smartphone application will use a proximity sensor to detect when the phone is brought to the user's ear and disable the touchscreen and turn off the backlight. For other applications, such as automatic dispensing, the soap or towel will be dispensed.

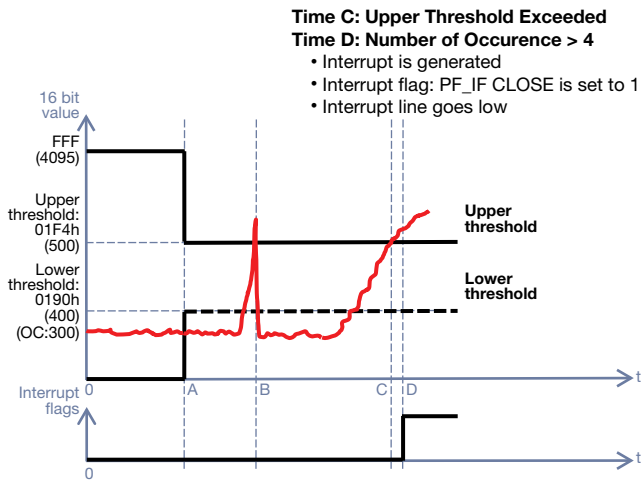

Fig. 24

In smartphone applications, the bottom threshold will also be programmed and wait for an interrupt signal. The prox\_threshold\_bottom should be set to "1" now and the

prox\_threshold\_top cleared by entering a "1" again, since the phone is already next to the user's ear. A lower threshold will occur when the phone call is complete and the phone is brought away from the user's ear, and the backlight and touchscreen will be turned back on.

For this example, the upper threshold will be set to 500 counts. The lower threshold is set to 400 counts; a value that is higher than the offset but low enough to indicate the removal of the phone from the user's ear.

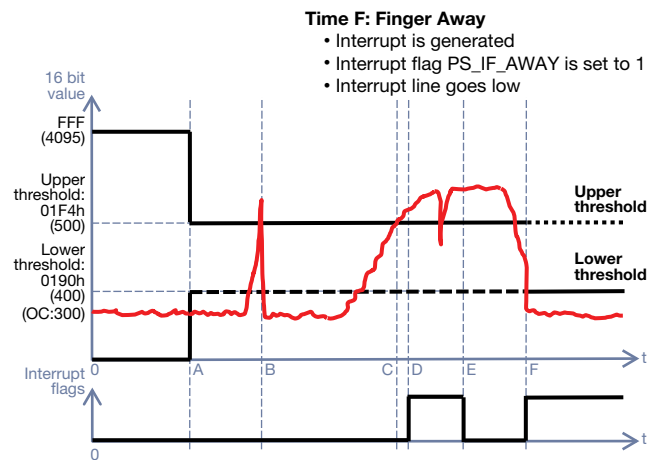

Fig. 25

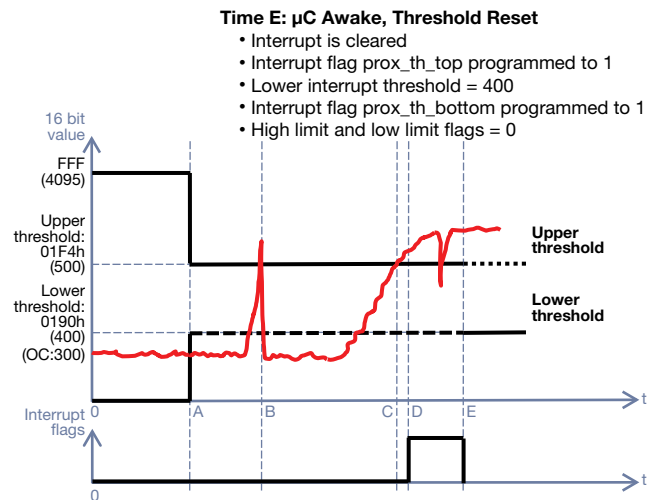

Fig. 26



The DNA of tech.™

# Designing the VCNL36825T Into an Application

## Interrupt Mode

TABLE 13 - INTERRUPT REGISTER DESCRIPTION				
Register	Command	Command Code	Bit	Description
PS_CONF2_L	PS_INT	0x03_L (0x03 data byte low)	3 : 2	(0 : 0) = interrupt disable, (0 : 1) = logic high / low mode, (1 : 0) = first high, (1 : 1) = interrupt enable
INT_FLAG	-	0xF9_H (0xF9 data byte high)	15 : 14 13 12 11 10 9 8	Reserved PS_ACFLAG, after PS finishing auto-calibration, INT raise PS_SPFLAG, PS entering protection mode Reserved Reserved PS_IF_CLOSE, PS rises above PS_THDH INT trigger event PS_IF_AWAY, PS drops below PS_THDL INT trigger event

The VCNL36825T has three interrupt modes which are “normal” interrupt mode, “first high” mode, and “logic high / low” mode. The user has to set the bit 3 : 2 within the register PS\_CONF2\_L. The description of each of the interrupt mode is as follows:

1. The “logic high / low” interrupt mode is selected with PS\_INT = trigger by logic high/low mode (0x03\_L, bit 3 : 2 = 0 : 1) within register PS\_CONF2\_L. When this mode is selected, the interrupt pin is pulled low (logic high) when the proximity counts reach the programmed high threshold (PS\_THDH) and will return to a high level (logic low) when counts drop below the count value for low threshold (PS\_THDL). There is no corresponding interrupt flag for this mode.
2. The “first high” interrupt mode is selected with PS\_INT = first high (0x03\_L, bit 3 : 2 = 1 : 0) within register PS\_CONF2\_L. In this mode, the initial interrupt event that is triggered needs to be with regard to the high threshold (PS\_THDH). Passing underneath the low threshold will have no effect until the first high threshold event has occurred. Therefore, the interrupt pin will be pulled low when the proximity counts first increase beyond the programmed high threshold (PS\_THDH), and simultaneously, the interrupt flag in the interrupt register will be set to “1”. On the other hand, after the first PS\_THDH event, the interrupt pin will also be pulled low when the proximity counts drop below the programmed low threshold (PS\_THDL) and simultaneously, the interrupt flag in the interrupt register will be set to “1”. The interrupt line will be pulled high again and the interrupt flag will be cleared to “0” once the interrupt register has been read.
3. The “normal” interrupt mode is selected with PS\_INT = interrupt enabled (0x03\_L, bit 3 : 2 = 1 : 1) within register PS\_CONF2\_L. When this mode is selected, the interrupt pin will be pulled low when the proximity counts increase beyond the programmed high threshold (PS\_THDH), and simultaneously, the interrupt flag in the interrupt register will be set to “1”. On the other hand, the interrupt pin will also be pulled low when the proximity counts drop below the programmed low threshold (PS\_THDL), and simultaneously, the interrupt flag in the interrupt register will be set to “1”. The interrupt line will be pulled high again and the interrupt flag will be cleared to “0” once the interrupt register has been read. The sequence which interrupts the event that occurs first, either PS\_THDH or PS\_THDL, does not play a role, unlike the “first high” mode.

The DNA of tech.™

## Designing the VCNL36825T Into an Application

Some measurements and features are shown with the demo tool and demo software with a cover glass at about a 1 mm distance.

1. Proximity set-up with 8T wide pulses, 20 mA VCSEL current, PS\_MPS = 8, and a period of 80 ms, which results in about 15 measurements per second

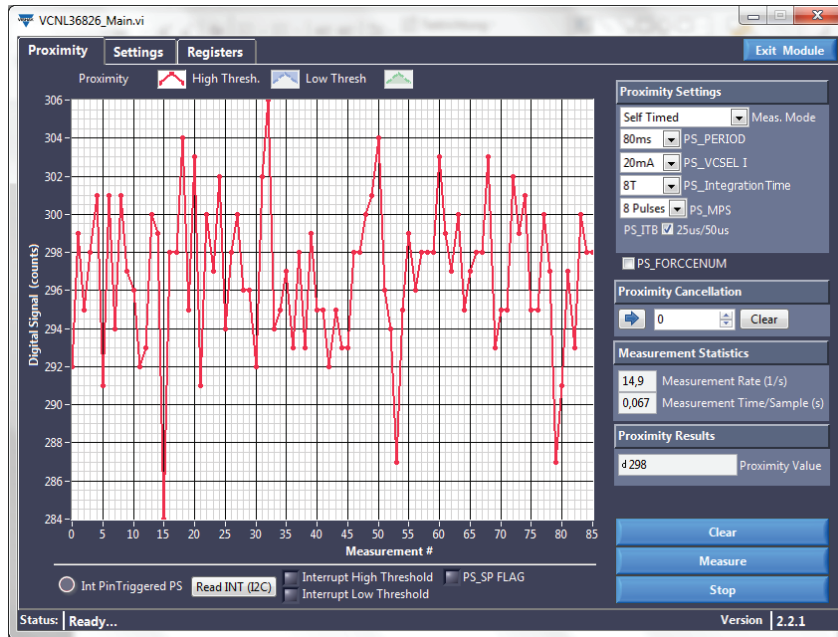

Fig. 27 - Screenshot of VCNL36825T Demo Software

2. If a hand or skin now comes as close as 5 cm, these 300 counts rise up to more than 500 counts.

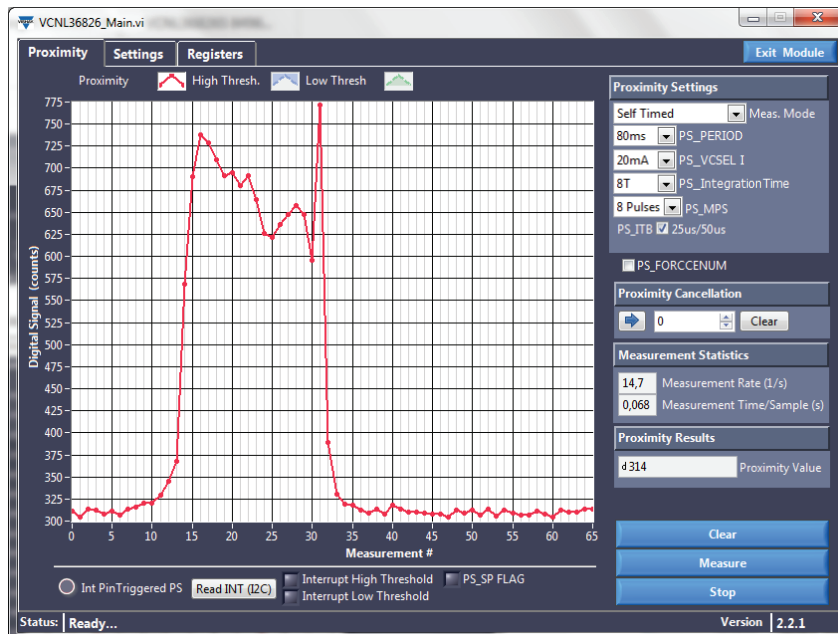

Fig. 28 - Hand in About 5 cm Distance Will Lead to More Than 500 Counts

The DNA of tech.™

## Designing the VCNL36825T Into an Application

- Here the thresholds are programmed as 500 for the upper and 400 for the lower. To see these, both “Show” buttons are activated. The presence of an object should only be recognized when four consecutive measurements are above that threshold.

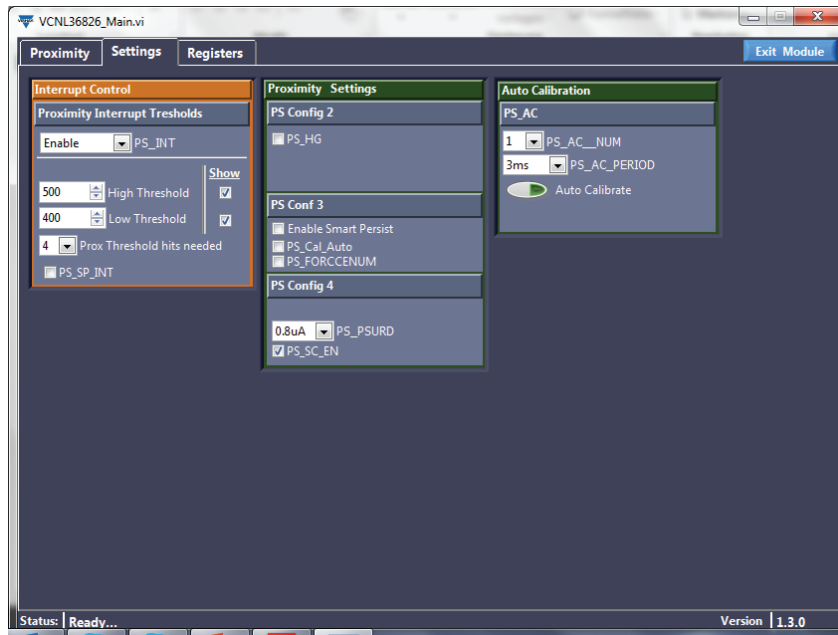

Fig. 29 - “Settings” Menu Within Demo Software

- Just one or two measurements above the threshold will not activate the interrupt.

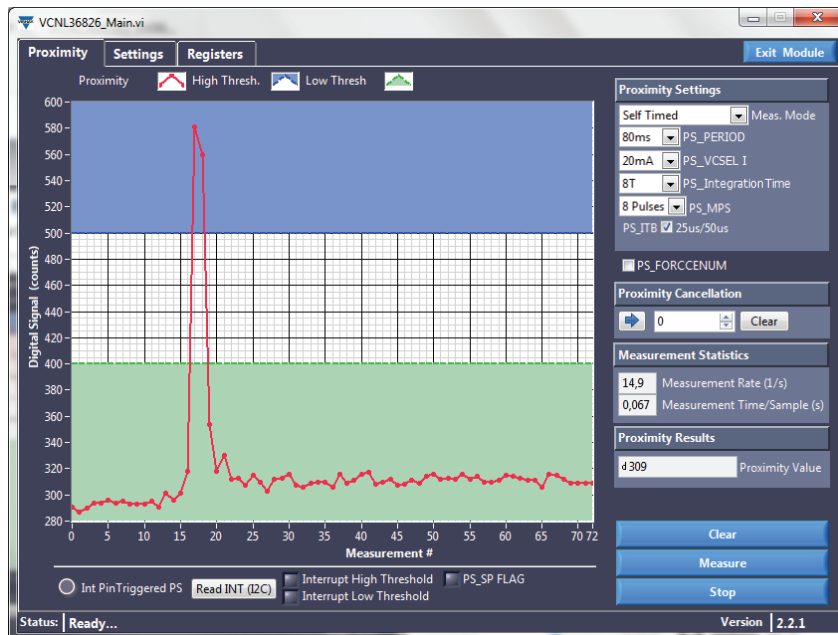

Fig. 30 - Upper and Lower Threshold Set and Hand in About 5 cm Distance



The DNA of tech.™

## Designing the VCNL36825T Into an Application

- With more than four measurements above the threshold, however, the interrupt is pulled low, as indicated by the red LED on the demo board and the red light: “Int Pin Triggered PS.”

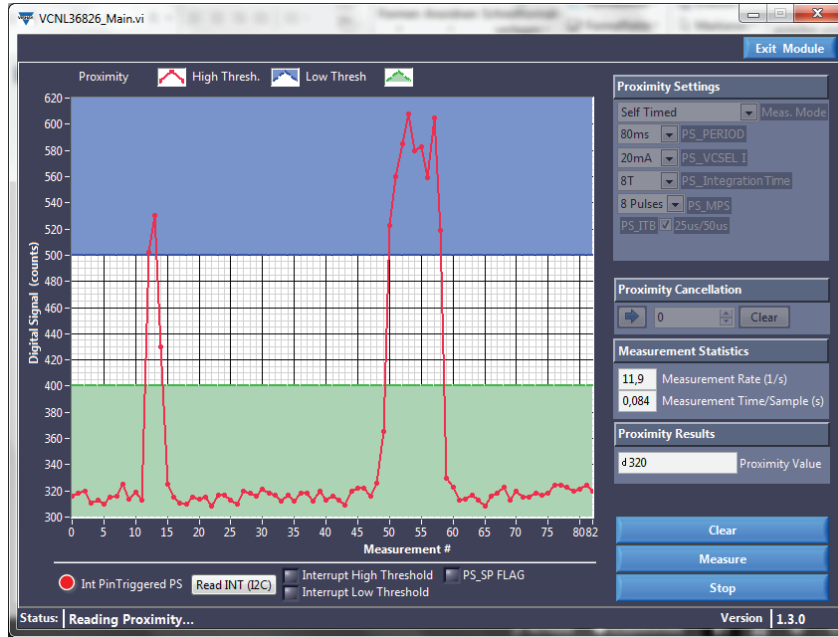

Fig. 31 - Hand in About 5 cm Distance for More Than 4 Consecutive Measurements Above Higher Threshold

- The cancellation feature is used below. The “before seen” offset counts are subtracted. To do so, the value of 300 is entered for register number 05 = Prox\_Cancellation.

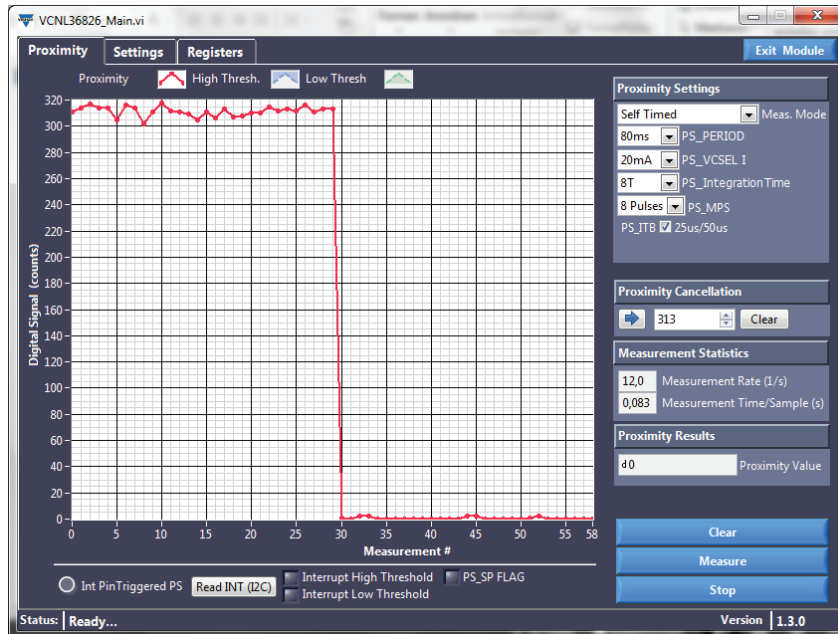

Fig. 32 - Cancellation Activated

The DNA of tech.™

## Designing the VCNL36825T Into an Application

- The “before seen” offset counts of about 300 are now subtracted:  $300 - 300 = 0$ . Also, the thresholds are now 300 counts lower. The higher threshold is 200 and lower is just 100.

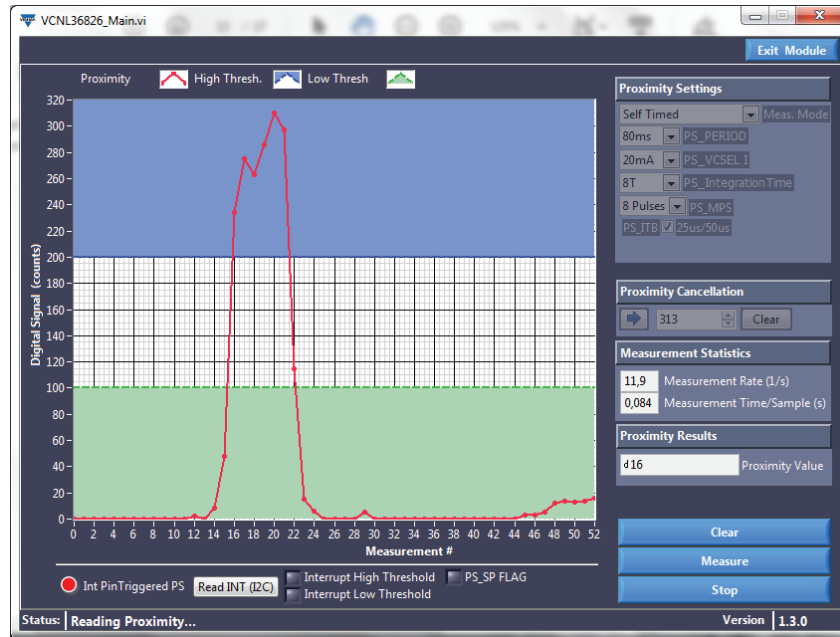

Fig. 33 - New Defined Thresholds With Cancellation Feature

If one chooses “logic mode” now and redefines the high threshold to 200 and low threshold as 100...

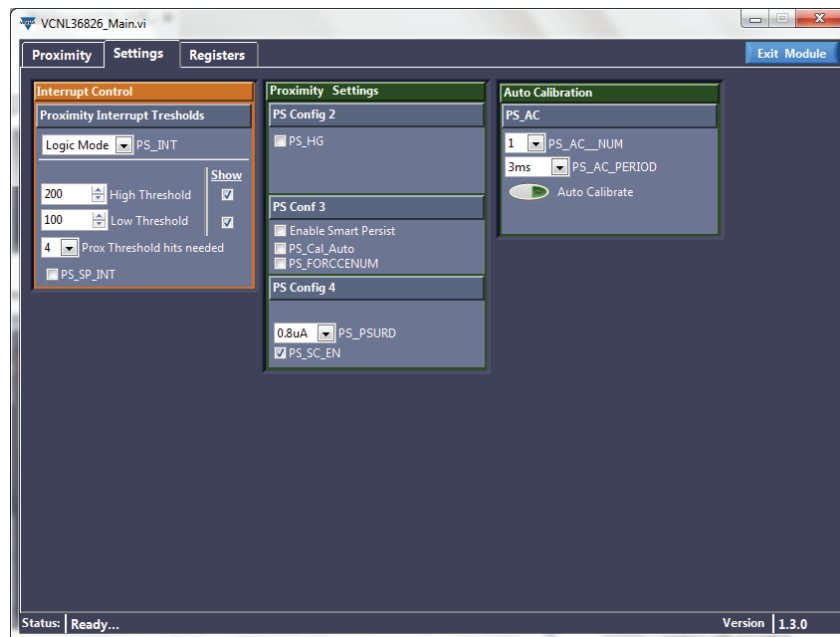

Fig. 34 - Logic Mode

The DNA of tech.™

## Designing the VCNL36825T Into an Application

... the interrupt will indicate the rise above the upper threshold and will also automatically be cleared when it falls below the lower threshold.

### SMART PERSIST

One special feature for faster proximity measurements is also implemented, which is called “smart persist.”

This feature reduces the total reaction time until the interrupt is set to active, although four consecutive measurements should be above (or below) the defined threshold for safe acknowledgment.

Without “smart persist”, but with programmed hits above the defined threshold set to four, it will take three times the time of PS\_PERIOD. With PS\_PERIOD set to 40 ms this would be 3 x 40 ms.

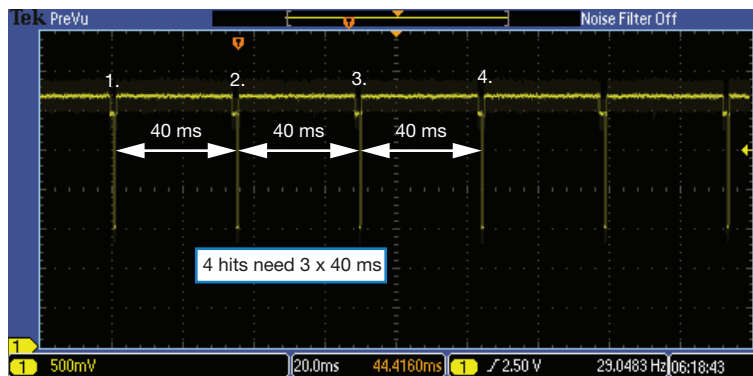
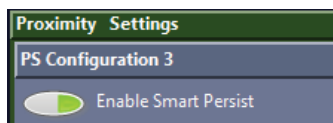

Fig. 35 - Interrupt Active After 4 Hits Above Threshold

With “smart persist” activated (bit 1 of PS\_CONF2\_L):

REGISTER: PS_CONF2_L DESCRIPTION		
REGISTER NAME		COMMAND CODE: 0x03_L (0x03 DATA BYTE LOW)
Command	Bit	Description
PS_PERIOD	7 : 6	(0 : 0) = 10 ms, (0 : 1) = 20 ms, (1 : 0) = 40 ms, (1 : 1) = 80 ms PS sample period setting
PS_PERS	5 : 4	(0 : 0) = 1, (0 : 1) = 2, (1 : 0) = 3, (1 : 1) = 4 PS interrupt persistence setting
PS_INT	3 : 2	(0 : 0) = interrupt disable, (0 : 1) = logic high / low mode, (1 : 0) = first away, (1 : 1) = interrupt enable
PS_SMART_PERS	1	0 = disable PS smart persistence, 1 = enable PS smart persistence
PS_ST	0	0 = PS start, 1 = PS stop, default = 1

or within the demo-tool:



The total needed time is reduced to just about 7 ms.

## Designing the VCNL36825T Into an Application

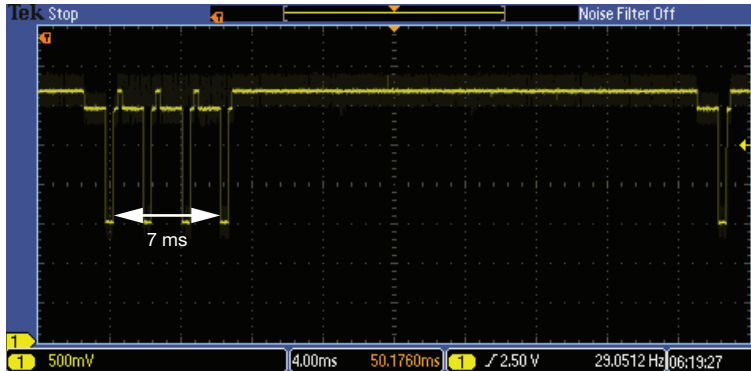

Fig. 36 - Smart Persist With PS\_IT = 8T = 400  $\mu$ s and PS\_PERIOD = 40 ms

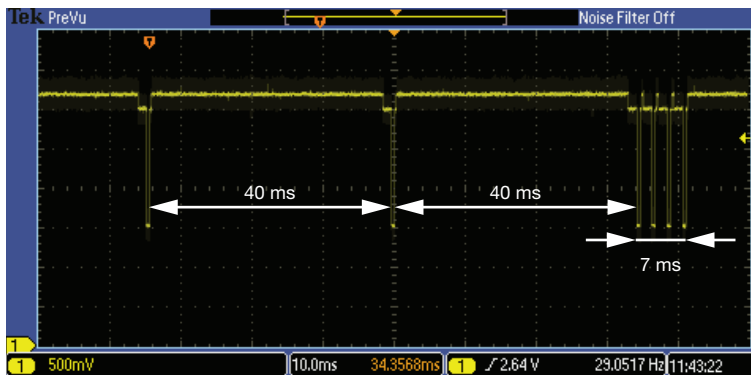

Fig. 37 - Always About 7 ms for These 4 Hits, Also When PS\_PERIOD is Programmed to Just 10 ms

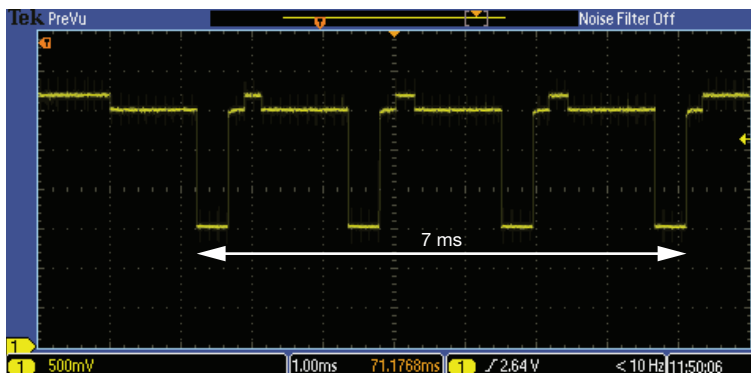

Fig. 38 - Smart Persist With Four Consecutive Proximity Pulses Short After Each Other

### MULTI PULSE FEATURE

For high detection ranges, the intensity for each proximity measurement will be chosen to the maximum possible value. This can be achieved by programming the VCSEL current to a maximum of 20 mA and longest measurement pulse PS\_IT of 400  $\mu$ s. Even further increase is possible using this so-called Multi-Pulse feature, PS\_MPS.

The DNA of tech.™

## Designing the VCNL36825T Into an Application

With this it is possible to send more than one pulse for a single proximity measurement. As shown within the table and illustrated with Fig. 39 and Fig. 40 below, a burst with either 2, 4, or even 8 pulses one after the other is possible.

REGISTER: PS_CONF2_H DESCRIPTION		
COMMAND CODE: 0x03_H (0x03 DATA BYTE HIGH)		
Command	Bit	Description
PS_IT	15 : 14	(0 : 0) = 1T, (0 : 1) = 2T, (1 : 0) = 4T, (1 : 1) = 8T
PS_MPS	13 : 12	(0 : 0) = 1, (0 : 1) = 2, (1 : 0) = 4, (1 : 1) = 8; PS multi-pulse setting
PS_ITB	11	0: ITB = 25 $\mu$ s, 1: ITB = 50 $\mu$ s
PS_HG	10	0 = disable, 1 = enable, PS high gain mode
Reserved	9 : 8	Default = (0 : 0)

With PS\_IT of 400  $\mu$ s and PS\_MPS = 8 this needs then about 6 ms for one measurement, see Fig. 39 below. Fig. 40 shows it with 4 pulses and Fig. 41 shows these 8 pulses within a period of 80 ms.

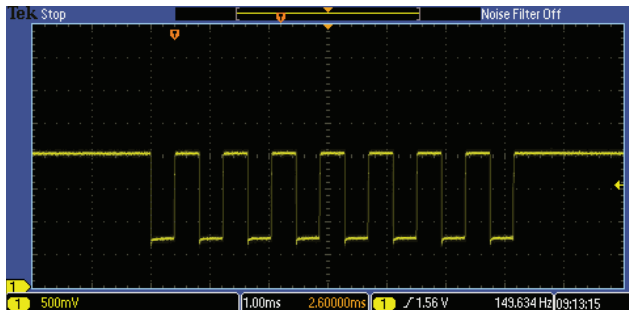

Fig. 39 - PS\_IT = 8T (400  $\mu$ s) and MPS = 8

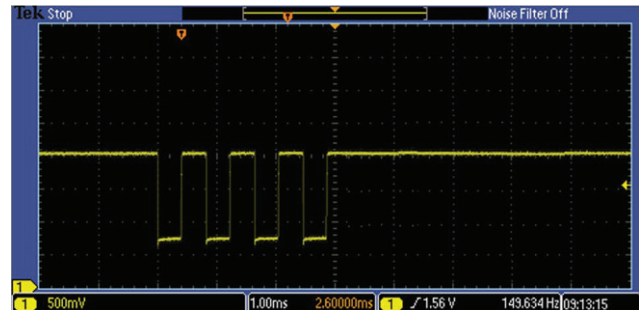

Fig. 40 - PS\_IT = 8T (400  $\mu$ s) and MPS = 4

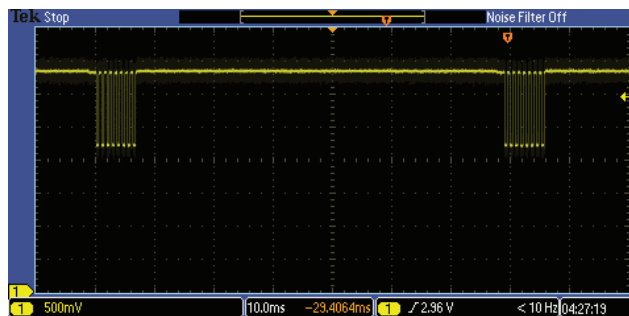

Fig. 41 - PS\_PERIOD = 80 ms and PS\_IT = 8T (400  $\mu$ s) and MPS = 8

With this much higher energy the detection distance could be increased up to about 40 cm (15 inch).

The DNA of tech.™

## Designing the VCNL36825T Into an Application

### AUTO CALIBRATION

This new feature offers a direct and internal subtraction of the so-called “offset” counts that are seen when the sensor is built-in within its end application where at least the cover will show significant offset counts.

To use this feature just this “PS\_AC” needs to be set to “1” = enable.

This auto calibration is carried out then with specific AC parameters that need to be chosen in advance: PS\_AC\_PERIOD and PS\_AC\_NUM. Possible periods are much faster than the ones for normal proximity measurements, just between 3 ms and 24 ms. The auto calibration is then done when PS\_AC\_TRIG is set. The whole procedure is shown within Fig. 42.

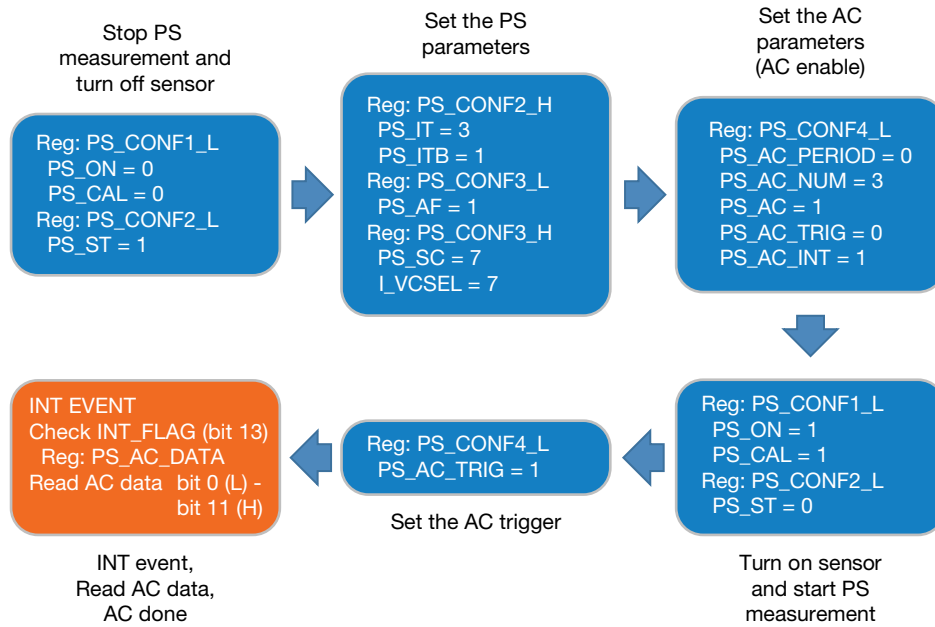

Fig. 42 - Software Flow Chart (for auto / dynamic calibration)

The DNA of tech.™

## Designing the VCNL36825T Into an Application

REGISTER: PS_CONF2_L Command Code: 0x03_L (0x03 Data Byte Low)		
COMMAND	BIT	Description
PS_PERIOD	7 : 6	(0 : 0) = 10 ms, (0 : 1) = 20 ms, (1 : 0) = 40 ms, (1 : 1) = 80 ms PS sample period setting

REGISTER: PS_CONF2_H Command Code: 0x03_H (0x03 Data Byte High)		
COMMAND	BIT	Description
PS_IT	15 : 14	(0 : 0) = 1T, (0 : 1) = 2T, (1 : 0) = 4T, (1 : 1) = 8T
PS_MPS	13 : 12	(0 : 0) = 1, (0 : 1) = 2, (1 : 0) = 4, (1 : 1) = 8 PS multi-pulse setting
PS_ITB	11	0: ITB = 25 μs, 1: ITB = 50 μs
PS_HG	10	0 = disable, 1 = enable, PS high gain mode
Reserved	9 : 8	Default = (0 : 0)

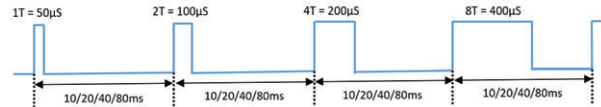

Fig. 43 - Normal PS Operation Setting

REGISTER: PS_CONF4_L Command Code: 0x08_L (0x08 Data Byte Low)		
COMMAND	BIT	Description
PS_AC_PERIOD	7 : 6	(0 : 0) = 3 ms, (0 : 1) = 6 ms, (1 : 0) = 12 ms, (1 : 1) = 24 ms PS auto-calibration detect sample period setting
PS_AC_NUM	5 : 4	(0 : 0) = 1, (0 : 1) = 2, (1 : 0) = 4, (1 : 1) = 8 PS auto-calibration detect sample number setting
PS_AC	3	0 = disable; 1 = enable PS auto-calibration enable; need set PS_AF = 1
PS_AC_TRIG	2	0 = disable; 1 = enable Trigger one time auto-calibration
Reserved	1	Reserved
PS_AC_INT	0	0 = disable; 1 = enable PS auto-calibration INT setting

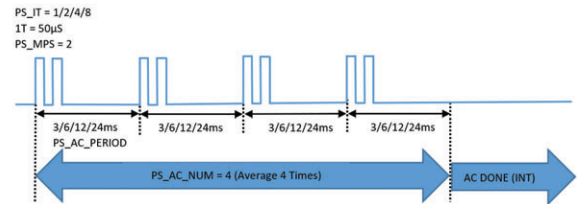

Fig. 44 - PS Auto Calibration Setting

REGISTER: PS_CONF4_L DESCRIPTION		
COMMAND CODE: 0x08_L (0x08 DATA BYTE LOW)		
Register	Bit	Description
PS_AC_PERIOD	7 : 6	(0 : 0) = 3 ms, (0 : 1) = 6 ms, (1 : 0) = 12 ms, (1 : 1) = 24 ms; PS auto-calibration detect sample period setting
PS_AC_NUM	5 : 4	(0 : 0) = 1, (0 : 1) = 2, (1 : 0) = 4, (1 : 1) = 8; PS auto-calibration detect sample number setting
PS_AC	3	0 = disable, 1 = enable; PS auto-calibration enable; need set PS_AF = 1
PS_AC_TRIG	2	0 = disable, 1 = enable; trigger one time auto-calibration
Reserved	1	Reserved
PS_AC_INT	0	0 = disable, 1 = enable; PS auto-calibration INT setting

APPLICATION NOTE



The DNA of tech.™

## Designing the VCNL36825T Into an Application

READ OUT REGISTER DESCRIPTION			
Register	Command Code	Bit	Description
PS_DATA_L	0xF8_L (0xF8 data byte low)	7 : 0	0x00 to 0xFF, PS output data (data byte low)
PS_DATA_H	0xF8_H (0xF8 data byte high)	11 : 8	0x00 to 0x0F, PS output data (data byte high)
INT_FLAG	0xF9_H (0xF9 data byte high)	15 : 14 13 12 11 10 9 8	Reserved PS_ACFLAG, after PS finishing auto-calibration, INT raise PS_SPFLAG, PS entering protection mode Reserved Reserved PS_IF_CLOSE, PS rises above PS_THDH INT trigger event PS_IF_AWAY, PS drops below PS_THDL INT trigger event
ID_L	0xFA_L (0xFA data byte low)	7 : 0	Default = 0010 0110, device ID (data byte low)
ID_H	0xFA_H (0xFA data byte high)	15 : 14 13 : 12 11 : 8	(0 : 0) (0 : 0) slave address = 0x60 Version code (0 : 0 : 0 : 0) device ID (data byte high)
PS_AC_DATA_L	0xFB_L (0xFB data byte low)	7 : 0	0x00 to 0xFF, PS auto-calibration data (data byte low)
PS_AC_DATA_H	0xFB_H (0xFB data byte high)	15 14 13 : 12 11 : 8	AC_BUSY, when AC, the bit will be "1" AC_SUN, PS enters sunlight protect during auto-calibration Reserved 0x00 to 0xFF, PS auto-calibration data (data byte high)