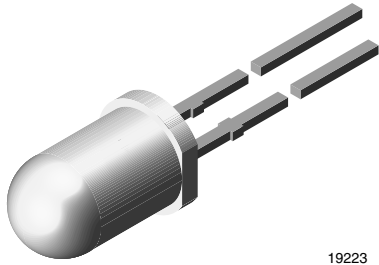




Ultrabright LED, Ø 5 mm Untinted Non-Diffused Package



19223

DESCRIPTION

The TLC.51.. series is a clear, non-diffused 5 mm LED for high end applications where supreme luminous intensity required.

These lamps with clear untinted plastic case utilize the highly developed ultrabright AllnGaP (AS).

The lens and the viewing angle is optimized to achieve best performance of light output and visibility.

PRODUCT GROUP AND PACKAGE DATA

- Product group: LED
- Package: 5 mm
- Product series: power
- Angle of half intensity: $\pm 9^\circ$

FEATURES

- Untinted non-diffused lens
- Utilizing ultrabright AllnGaP (AS)
- High luminous intensity
- High operating temperature: T_j (chip junction temperature) up to 125 °C for AllnGaP devices
- Luminous intensity and color categorized for each packing unit
- ESD-withstand voltage: up to 2 kV according to JESD22-A114-B
- Material categorization: for definitions of compliance please see www.vishay.com/doc?99912



APPLICATIONS

- Interior and exterior lighting
- Outdoor LED panels
- Instrumentation and front panel indicators
- Central high mounted stop lights (CHMSL) for motor vehicles
- Replaces incandescent lamps
- Traffic signals
- Light guide design

PARTS TABLE														
PART	COLOR	LUMINOUS INTENSITY (mcd)			at I _F (mA)	WAVELENGTH (nm)			at I _F (mA)	FORWARD VOLTAGE (V)			at I _F (mA)	TECHNOLOGY
		MIN.	TYP.	MAX.		MIN.	TYP.	MAX.		MIN.	TYP.	MAX.		
TLCS5100	Super red	2400	7500	-	50	626	630	638	50	-	2.1	2.7	50	AllnGaP on GaAs
TLCR5100	Red	4300	11 000	-	50	611	616	622	50	-	2.1	2.7	50	AllnGaP on GaAs
TLCYG5100	Yellow green	1350	3500	-	50	565	572	576	50	-	2.2	2.7	50	AllnGaP on GaAs
TLCPG5100	Pure green	430	1250	-	50	555	562	567	50	-	2.1	2.7	50	AllnGaP on GaAs

ABSOLUTE MAXIMUM RATINGS ($T_{amb} = 25^\circ\text{C}$, unless otherwise specified) TLCS5100, TLCR5100, TLCYG5100, TLCPG5100				
PARAMETER	TEST CONDITION	SYMBOL	VALUE	UNIT
Reverse voltage ⁽¹⁾		V_R	5	V
DC forward current	$T_{amb} \leq 85^\circ\text{C}$	I_F	50	mA
Surge forward current	$t_p \leq 10 \mu\text{s}$	I_{FSM}	1	A
Power dissipation		P_V	135	mW
Junction temperature		T_j	125	°C
Operating temperature range		T_{amb}	-40 to +100	°C
Storage temperature range		T_{stg}	-40 to +100	°C
Soldering temperature	$t \leq 5 \text{ s}$, 2 mm from body	T_{sd}	260	°C
Thermal resistance junction to ambient		R_{thJA}	300	K/W

Note

⁽¹⁾ Driving the LED in reverse direction is suitable for a short term application

**OPTICAL AND ELECTRICAL CHARACTERISTICS** ($T_{amb} = 25\text{ }^{\circ}\text{C}$, unless otherwise specified)
TLCS5100, SUPER RED

PARAMETER	TEST CONDITION	PART	SYMBOL	MIN.	TYP.	MAX.	UNIT
Luminous intensity ⁽¹⁾	$I_F = 50\text{ mA}$	TLCS5100	I_V	2400	7500	-	mcd
Dominant wavelength	$I_F = 50\text{ mA}$		λ_d	626	630	638	nm
Peak wavelength	$I_F = 50\text{ mA}$		λ_p	-	641	-	nm
Spectral bandwidth at 50 % $I_{rel\ max.}$	$I_F = 50\text{ mA}$		$\Delta\lambda$	-	20	-	nm
Angle of half intensity	$I_F = 50\text{ mA}$		ϕ	-	± 9	-	$^{\circ}$
Forward voltage	$I_F = 50\text{ mA}$		V_F	-	2.1	2.7	V
Reverse voltage	$I_R = 10\text{ }\mu\text{A}$		V_R	5	-	-	V
Temperature coefficient of V_F	$I_F = 50\text{ mA}$		TC_{VF}	-	-2	-	mV/K
Temperature coefficient of λ_d	$I_F = 50\text{ mA}$		TC_{λ_d}	-	0.04	-	nm/K

Note⁽¹⁾ In one packing unit $I_{Vmax.}/I_{Vmin.} \leq 2.0$ **OPTICAL AND ELECTRICAL CHARACTERISTICS** ($T_{amb} = 25\text{ }^{\circ}\text{C}$, unless otherwise specified)
TLCR5100, RED

PARAMETER	TEST CONDITION	PART	SYMBOL	MIN.	TYP.	MAX.	UNIT
Luminous intensity ⁽¹⁾	$I_F = 50\text{ mA}$	TLCR5100	I_V	4300	11 000	-	mcd
Dominant wavelength	$I_F = 50\text{ mA}$		λ_d	611	616	622	nm
Peak wavelength	$I_F = 50\text{ mA}$		λ_p	-	622	-	nm
Spectral bandwidth at 50 % $I_{rel\ max.}$	$I_F = 50\text{ mA}$		$\Delta\lambda$	-	18	-	nm
Angle of half intensity	$I_F = 50\text{ mA}$		ϕ	-	± 9	-	$^{\circ}$
Forward voltage	$I_F = 50\text{ mA}$		V_F	-	2.1	2.7	V
Reverse voltage	$I_R = 10\text{ }\mu\text{A}$		V_R	5	-	-	V
Temperature coefficient of V_F	$I_F = 50\text{ mA}$		TC_{VF}	-	-3.5	-	mV/K
Temperature coefficient of λ_d	$I_F = 50\text{ mA}$		TC_{λ_d}	-	0.05	-	nm/K

Note⁽¹⁾ In one packing unit $I_{Vmax.}/I_{Vmin.} \leq 2.0$ **OPTICAL AND ELECTRICAL CHARACTERISTICS** ($T_{amb} = 25\text{ }^{\circ}\text{C}$, unless otherwise specified)
TLCYG5100, YELLOW GREEN

PARAMETER	TEST CONDITION	PART	SYMBOL	MIN.	TYP.	MAX.	UNIT
Luminous intensity ⁽¹⁾	$I_F = 50\text{ mA}$	TLCYG5100	I_V	1350	3500	-	mcd
Dominant wavelength	$I_F = 50\text{ mA}$		λ_d	565	572	576	nm
Peak wavelength	$I_F = 50\text{ mA}$		λ_p	-	574	-	nm
Spectral bandwidth at 50 % $I_{rel\ max.}$	$I_F = 50\text{ mA}$		$\Delta\lambda$	-	15	-	nm
Angle of half intensity	$I_F = 50\text{ mA}$		ϕ	-	± 9	-	$^{\circ}$
Forward voltage	$I_F = 50\text{ mA}$		V_F	-	2.2	2.7	V
Reverse voltage	$I_R = 10\text{ }\mu\text{A}$		V_R	5	-	-	V
Temperature coefficient of V_F	$I_F = 50\text{ mA}$		TC_{VF}	-	-4.5	-	mV/K
Temperature coefficient of λ_d	$I_F = 50\text{ mA}$		TC_{λ_d}	-	0.1	-	nm/K

Note⁽¹⁾ In one packing unit $I_{Vmax.}/I_{Vmin.} \leq 2.0$

**OPTICAL AND ELECTRICAL CHARACTERISTICS** ($T_{amb} = 25\text{ }^{\circ}\text{C}$, unless otherwise specified)
TLCPG5100, PURE GREEN

PARAMETER	TEST CONDITION	PART	SYMBOL	MIN.	TYP.	MAX.	UNIT
Luminous intensity ⁽¹⁾	$I_F = 50\text{ mA}$	TLCPG5100	I_V	430	1250	-	mcd
Dominant wavelength	$I_F = 50\text{ mA}$		λ_d	555	562	567	nm
Peak wavelength	$I_F = 50\text{ mA}$		λ_p	-	563	-	nm
Spectral bandwidth at 50 % $I_{rel\ max.}$	$I_F = 50\text{ mA}$		$\Delta\lambda$	-	20	-	nm
Angle of half intensity	$I_F = 50\text{ mA}$		ϕ	-	± 9	-	$^{\circ}$
Forward voltage	$I_F = 50\text{ mA}$		V_F	-	2.1	2.7	V
Reverse voltage	$I_R = 10\ \mu\text{A}$		V_R	5	-	-	V
Temperature coefficient of V_F	$I_F = 50\text{ mA}$		TC_{V_F}	-	-3.5	-	mV/K
Temperature coefficient of λ_d	$I_F = 50\text{ mA}$		TC_{λ_d}	-	0.1	-	nm/K

Note

⁽¹⁾ In one packing unit $I_{Vmax.}/I_{Vmin.} \leq 2.0$

LUMINOUS INTENSITY CLASSIFICATION

GROUP STANDARD	LUMINOUS INTENSITY (mcd)	
	MIN.	MAX.
BB	430	860
CC	575	1150
DD	750	1500
EE	1000	2000
FF	1350	2700
GG	1800	3600
HH	2400	4800
II	3200	6400
KK	4300	8600
LL	5750	11 500
MM	7500	15 000
NN	10 000	20 000
PP	13 500	27 000
QQ	18 000	36 000
RR	24 000	48 000
SS	32 000	64 000
TT	43 000	86 000
UU	57 500	115 000

Note

- Luminous intensity is tested at a current pulse duration of 25 ms and an accuracy of $\pm 11\%$.
The above type numbers represent the order groups which include only a few brightness groups. Only one group will be shipped on each bag (there will be no mixing of two groups on each bag).
In order to ensure availability, single brightness groups will not be orderable.
In a similar manner for colors where wavelength groups are measured and binned, single wavelength groups will be shipped in any one bag.
In order to ensure availability, single wavelength groups will not be orderable

COLOR CLASSIFICATION						
GROUP	DOM. WAVELENGTH (nm)					
	RED		YELLOW GREEN		PURE GREEN	
	MIN.	MAX.	MIN.	MAX.	MIN.	MAX.
0	-	-	-	-	555	559
1	611	618	-	-	558	561
2	614	622	-	-	560	563
3	-	-	-	-	562	565
4	-	-	-	-	564	567
5	-	-	565	570	-	-
6	-	-	567	572	-	-
7	-	-	569	574	-	-
8	-	-	571	576	-	-

Note

- Wavelengths are tested at a current pulse duration of 25 ms and an accuracy of ± 1 nm

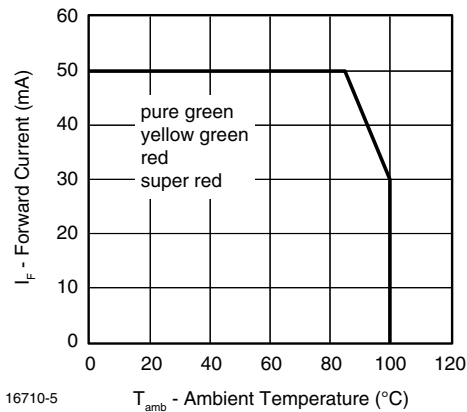
TYPICAL CHARACTERISTICS ($T_{amb} = 25^\circ\text{C}$, unless otherwise specified)


Fig. 1 - Forward Current vs. Ambient Temperature

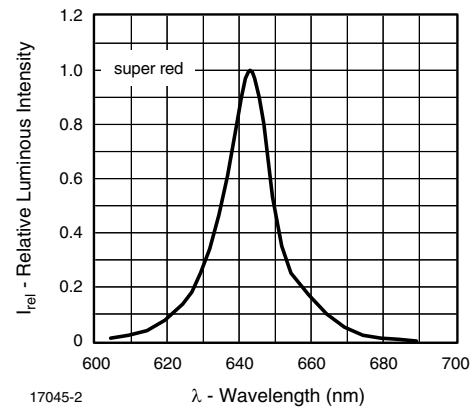


Fig. 3 - Relative Intensity vs. Wavelength

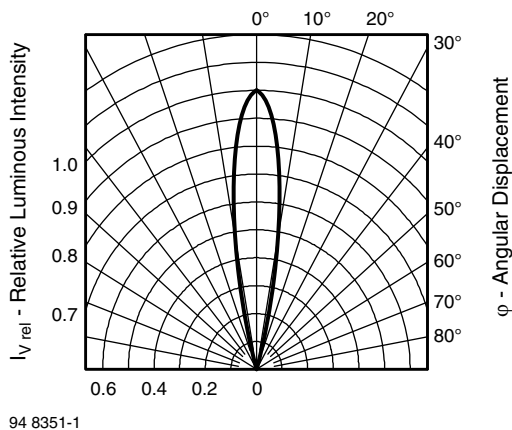


Fig. 2 - Relative Luminous Intensity vs. Angular Displacement

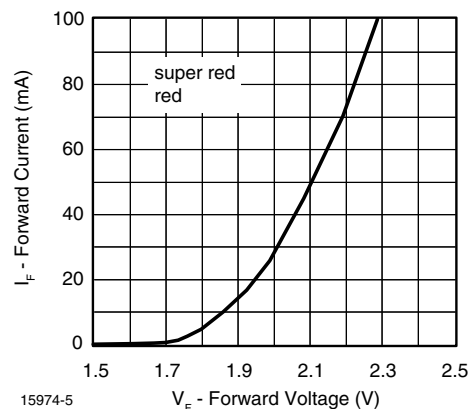


Fig. 4 - Forward Current vs. Forward Voltage

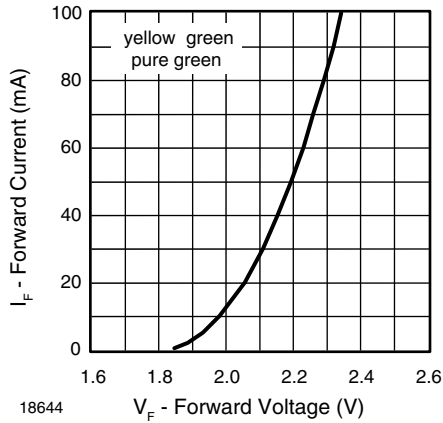


Fig. 5 - Forward Current vs. Forward Voltage

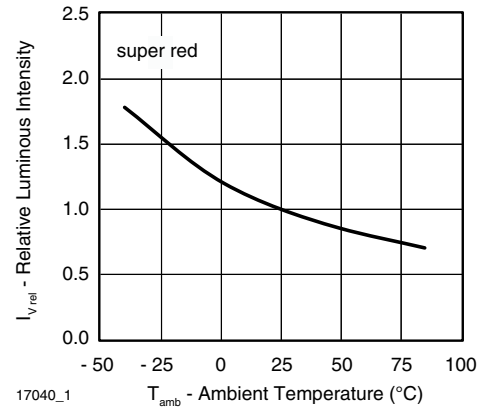


Fig. 8 - Relative Luminous Intensity vs. Ambient Temperature

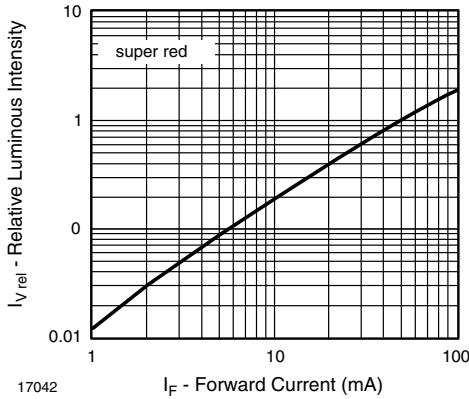


Fig. 6 - Relative Luminous Intensity vs. Forward Current

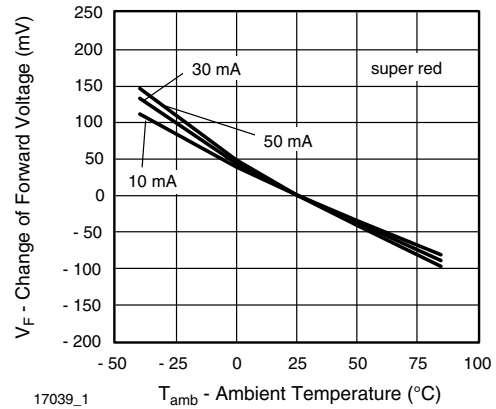


Fig. 9 - Change of Forward Voltage vs. Ambient Temperature

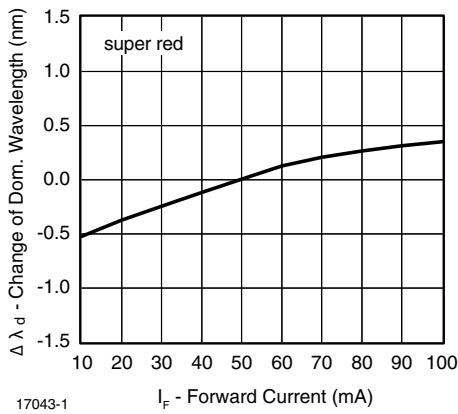


Fig. 7 - Change of Dominant Wavelength vs. Ambient Temperature

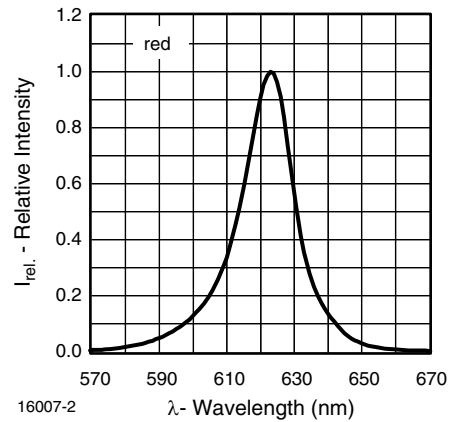


Fig. 10 - Relative Intensity vs. Wavelength

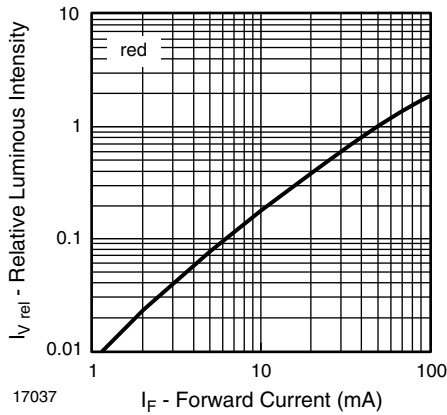


Fig. 11 - Relative Luminous Intensity vs. Forward Current

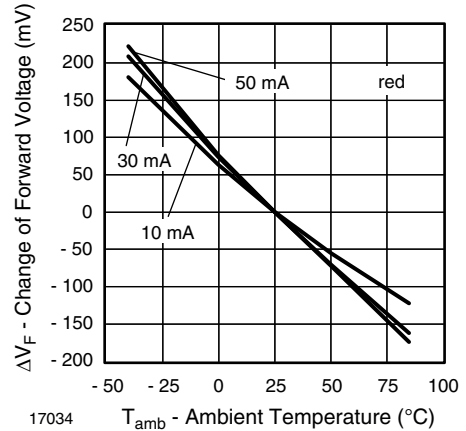


Fig. 14 - Change of Forward Voltage vs. Ambient Temperature

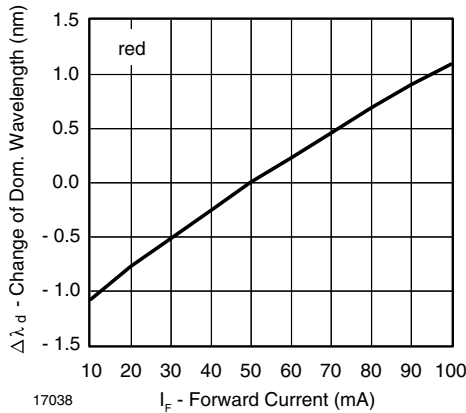


Fig. 12 - Changes of Dominant Wavelength vs. Forward Current

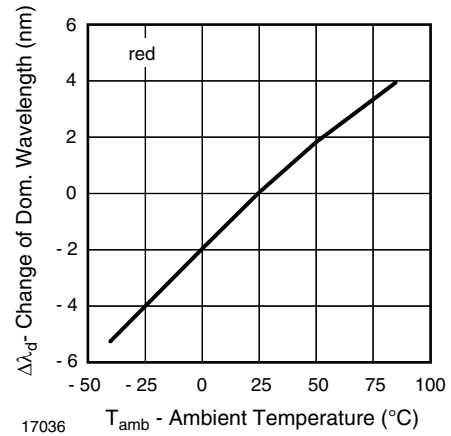


Fig. 15 - Change of Dominant Wavelength vs. Ambient Temperature

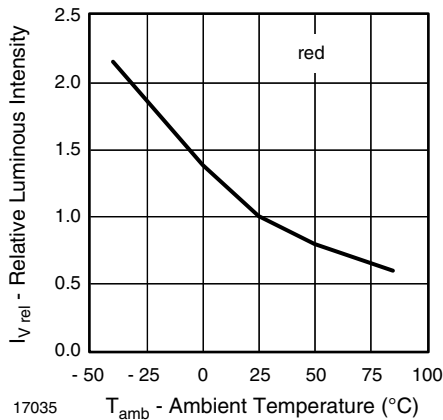


Fig. 13 - Relative Luminous Intensity vs. Ambient Temperature

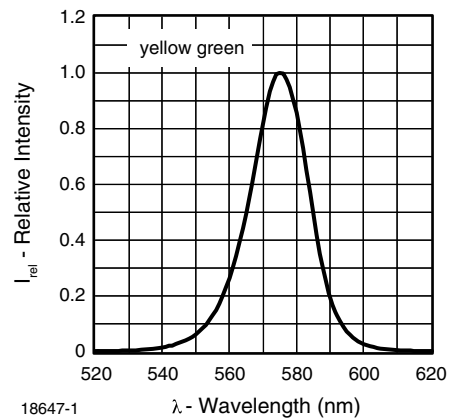


Fig. 16 - Relative Intensity vs. Wavelength

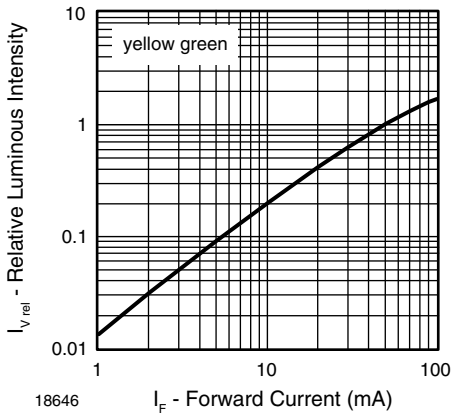


Fig. 17 - Relative Luminous Intensity vs. Forward Current

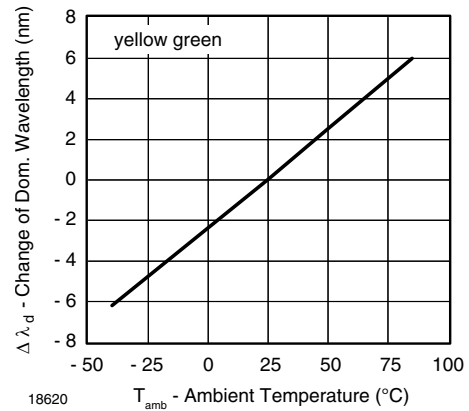


Fig. 20 - Change of Dominant Wavelength vs. Ambient Temperature

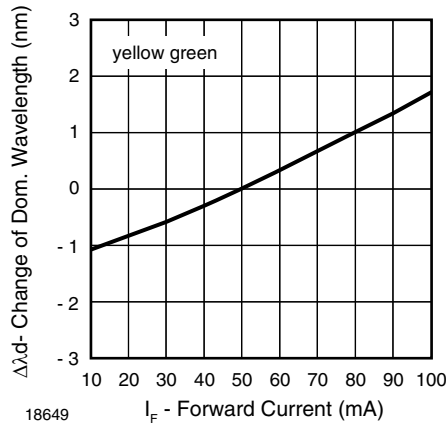


Fig. 18 - Change of Dominant Wavelength vs. Forward Current

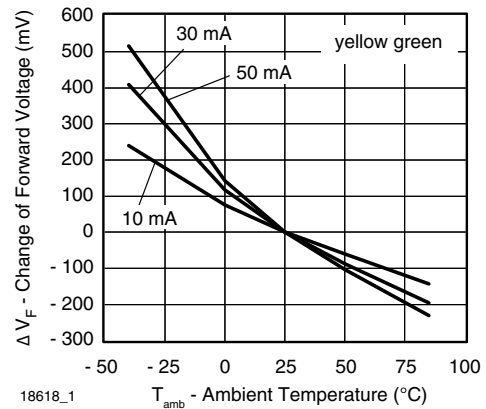


Fig. 21 - Change of Forward Voltage vs. Ambient Temperature

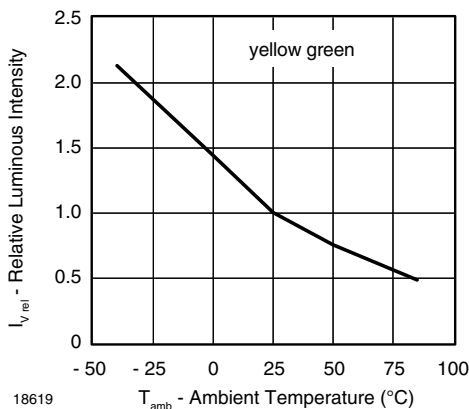


Fig. 19 - Relative Luminous Intensity vs. Ambient Temperature

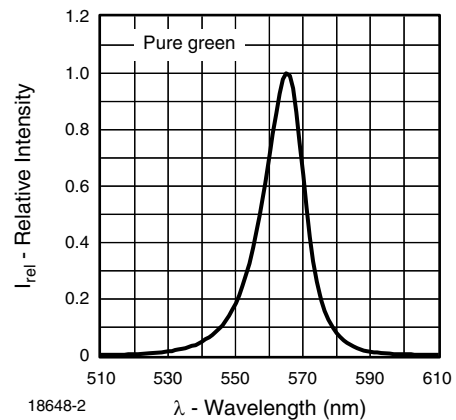


Fig. 22 - Relative Intensity vs. Wavelength

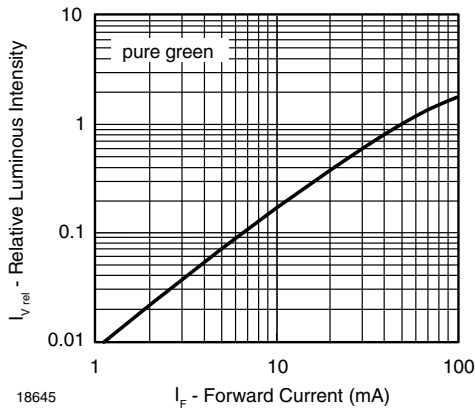


Fig. 23 - Relative Luminous Intensity vs. Forward Current

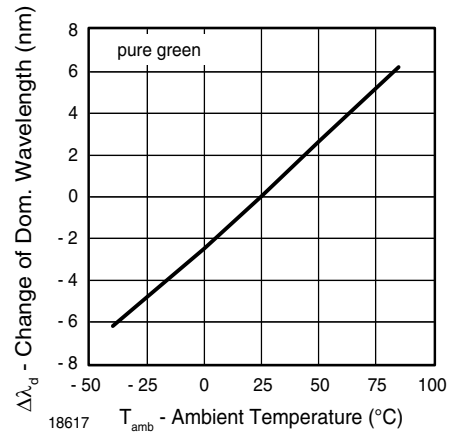


Fig. 26 - Change of Dominant Wavelength vs. Ambient Temperature

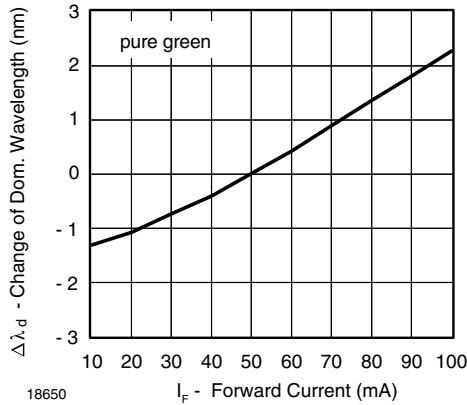


Fig. 24 - Change of Dominant Wavelength vs. Forward Current

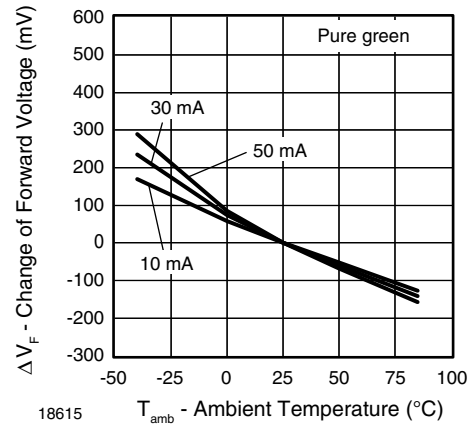


Fig. 27 - Change of Forward Voltage vs. Ambient Temperature

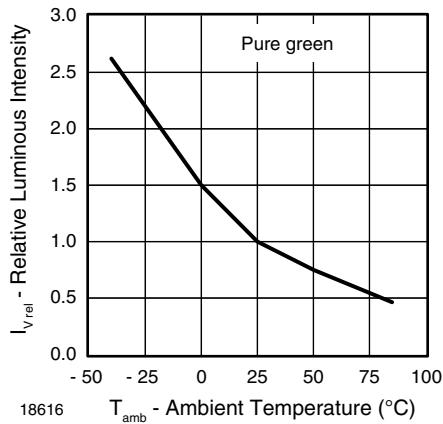
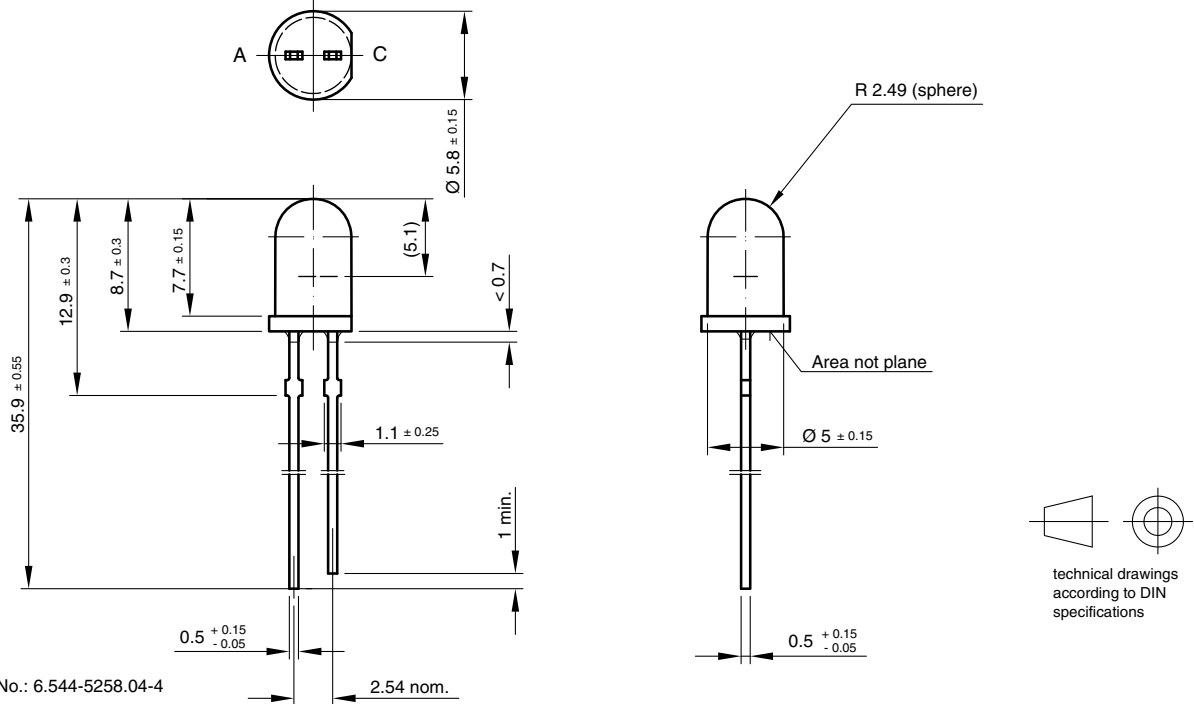


Fig. 25 - Relative Luminous Intensity vs. Ambient Temperature



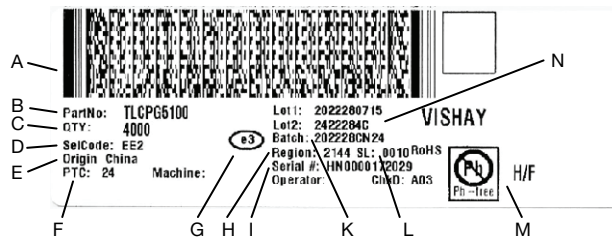
PACKAGE DIMENSIONS in millimeters



Drawing-No.: 6.544-5258.04-4
 Issue: 9; 23.07.10
 96 12121

PACKING		
MATERIAL	PACKING	QUANTITY
TLCx5100	Bulk	4000

BAR CODE PRODUCT LABEL (example)



- A. 2D barcode
- B. Part No: Vishay part number
- C. QTY: quantity
- D. SelCode: selection bin code
- E. Country of origin
- F. PTC: production plant code
- G. Termination finish
- H. Region code
- I. Serial#: serial number
- K. Batch number: year, week, country code, plant code
- L. SL: storage location
- M. Environmental symbols: RoHS, lead (Pb)-free, halogen-free
- N. Lot numbers



Disclaimer

ALL PRODUCT, PRODUCT SPECIFICATIONS AND DATA ARE SUBJECT TO CHANGE WITHOUT NOTICE TO IMPROVE RELIABILITY, FUNCTION OR DESIGN OR OTHERWISE.

Vishay Intertechnology, Inc., its affiliates, agents, and employees, and all persons acting on its or their behalf (collectively, "Vishay"), disclaim any and all liability for any errors, inaccuracies or incompleteness contained in any datasheet or in any other disclosure relating to any product.

Vishay makes no warranty, representation or guarantee regarding the suitability of the products for any particular purpose or the continuing production of any product. To the maximum extent permitted by applicable law, Vishay disclaims (i) any and all liability arising out of the application or use of any product, (ii) any and all liability, including without limitation special, consequential or incidental damages, and (iii) any and all implied warranties, including warranties of fitness for particular purpose, non-infringement and merchantability.

Statements regarding the suitability of products for certain types of applications are based on Vishay's knowledge of typical requirements that are often placed on Vishay products in generic applications. Such statements are not binding statements about the suitability of products for a particular application. It is the customer's responsibility to validate that a particular product with the properties described in the product specification is suitable for use in a particular application. Parameters provided in datasheets and / or specifications may vary in different applications and performance may vary over time. All operating parameters, including typical parameters, must be validated for each customer application by the customer's technical experts. Product specifications do not expand or otherwise modify Vishay's terms and conditions of purchase, including but not limited to the warranty expressed therein.

Hyperlinks included in this datasheet may direct users to third-party websites. These links are provided as a convenience and for informational purposes only. Inclusion of these hyperlinks does not constitute an endorsement or an approval by Vishay of any of the products, services or opinions of the corporation, organization or individual associated with the third-party website. Vishay disclaims any and all liability and bears no responsibility for the accuracy, legality or content of the third-party website or for that of subsequent links.

Except as expressly indicated in writing, Vishay products are not designed for use in medical, life-saving, or life-sustaining applications or for any other application in which the failure of the Vishay product could result in personal injury or death. Customers using or selling Vishay products not expressly indicated for use in such applications do so at their own risk. Please contact authorized Vishay personnel to obtain written terms and conditions regarding products designed for such applications.

No license, express or implied, by estoppel or otherwise, to any intellectual property rights is granted by this document or by any conduct of Vishay. Product names and markings noted herein may be trademarks of their respective owners.