



Designing the VEML6040 RGBW Color Sensor Into Applications

By Reinhard Schaar

The VEML6040 is an advanced RGB / ambient light sensor with an I²C protocol interface and designed with CMOS technology.

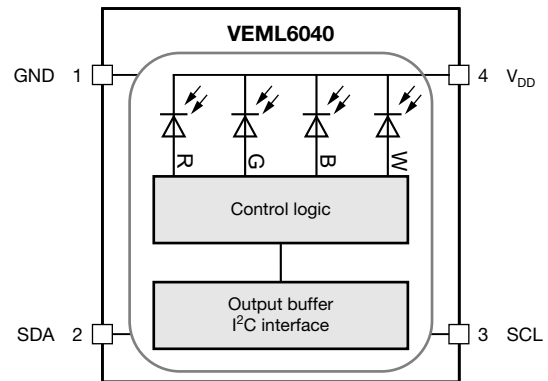
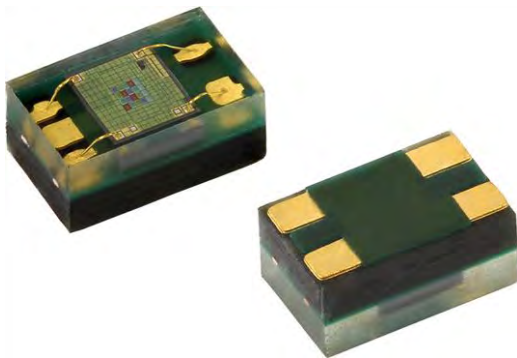

Fig. 1 - VEML6040 Block Diagram

The VEML6040 color sensor senses red, green, blue, and white light and incorporates photodiodes, amplifiers, and analog / digital circuits into a single CMOS chip. This digital RGBW information can be used in feedback control systems, among other things, to monitor and actively control a light source. For example, with the color sensor applied, the brightness and color temperature of a backlight can be adjusted, based on the ambient light conditions, in order to make the panel look more comfortable to the user's eyes. The VEML6040's adoption of the Filtron™ technology achieves an accurate response to the mid of each requested band for the red, green, and blue channel. Furthermore, it provides excellent temperature compensation, keeping the output stable under changing temperatures.

The VEML6040's functions are easily operated via simple commands sent over the I²C (SMBus compatible) bus.

The VEML6040 is packaged in a lead (Pb)-free 4-pin OPLGA package, which offers the best market-proven reliability.

The VEML6040 comes within a very small surface-mount package with dimensions of just 2.0 mm x 1.25 mm x 1.0 mm (L x W x H).

Designing the VEML6040 RGBW Color Sensor Into Applications

VEML6040 RGB SENSOR APPLICATIONS

- Automatic white balancing of digital cameras
- Eliminate unsightly blue or orange color casts
- Adjust the backlight of an LCD display to provide a white balance in all ambient light conditions
- Actively monitor and control the color output of LEDs

APPLICATION CIRCUIT FOR THE VEML6040

The VEML6040 operates within a supply voltage range from 2.5 V to 3.6 V. The necessary pull-up resistors for the I²C lines can be connected to the same supply as the host micro controller, and have a range between 1.7 V and 3.6 V.

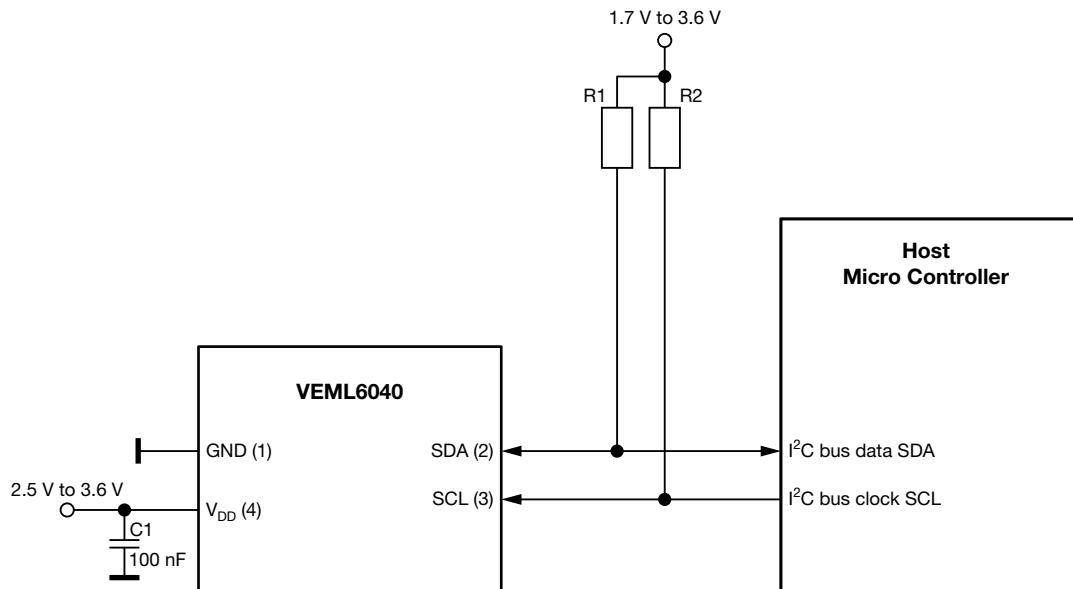

Fig. 2 - Application Circuit

The value of the pull-up resistors should be from 2.2 k Ω to 4.7 k Ω .

The current consumption of the VEML6040 is typically 200 μ A when measurements are being made. In the shut-down mode, which can always be chosen between any measurements (SD = 1), the current consumption goes down to about 800 nA.

Designing the VEML6040 RGBW Color Sensor Into Applications

SPECTRAL SENSITIVITY

The VEML6040 has peak sensitivities for red, green, and blue at 645 nm, 575 nm, and 460 nm, respectively. The bandwidth ($\lambda_{0.5}$) is shown to be ± 45 nm for red and green and about ± 35 nm for blue.

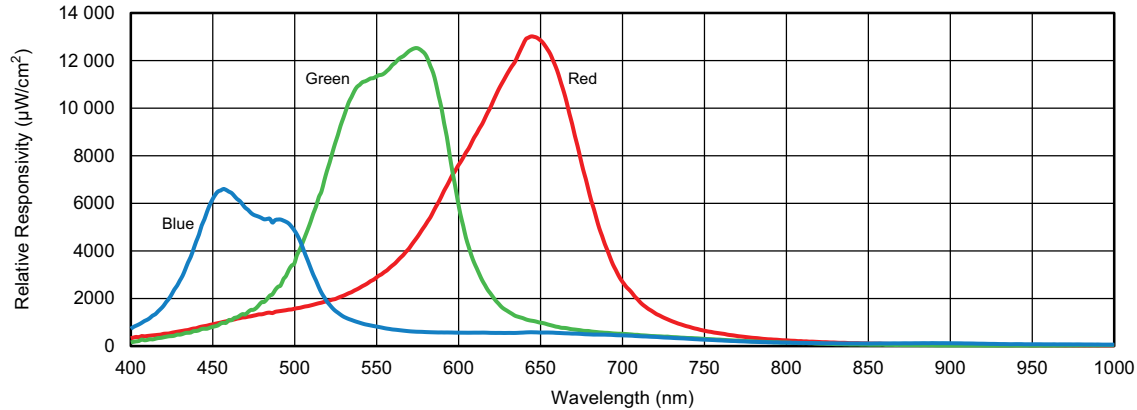

Fig. 3 - Relative Responsivity vs. Wavelength

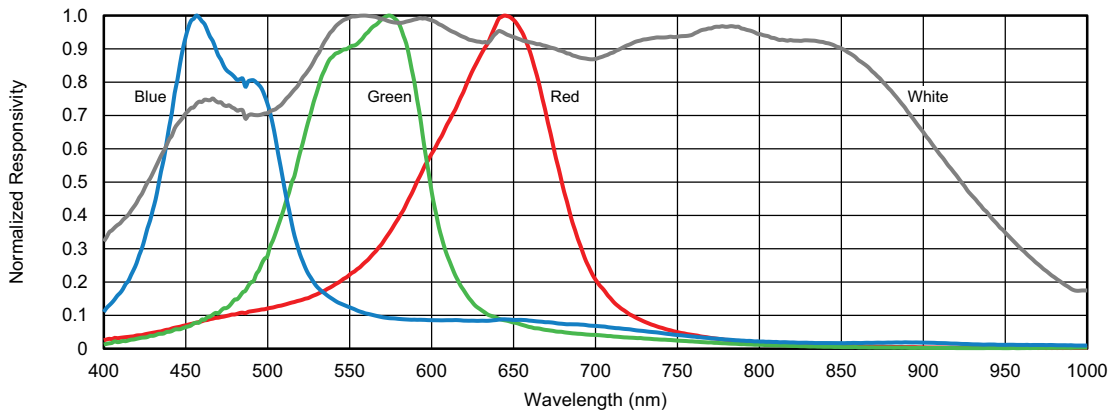

Fig. 4 - Normalized Responsivity vs. Wavelength



Designing the VEML6040 RGBW Color Sensor Into Applications

INITIALIZATION AND MEASUREMENT MODES

Set-up and initialization of the VEML6040 is done over the shutdown (SD) bit in register #0. Setting SD = 0 enables the device and starts measurements in either auto (self-timed) mode or “Active Force” mode. Upon setting SD = 0 with the bit AF = 0, the so-called “Auto” mode is started, and measurements are made continuously until SD is set to 1. With AF = 1, only a single measurement is made, after which the component waits for the next command. This single measurement cycle is triggered by setting TRIG = 1.

TABLE 1-1 - COMMAND CODE 00H BITS DESCRIPTION							
SLAVE ADDRESS: 0x10; REGISTER NAME: CONF; COMMAND CODE: 00H / DATA BYTE LOW							
X	IT			X	TRIG	AF	SD
BIT 7	BIT 6	BIT 5	BIT 4	BIT 3	BIT 2	BIT 1	BIT 0
0	IT2	IT1	IT0	0	TRIG	AF	SD
DESCRIPTION							
IT		Integration time setting					
TRIG		Proceed one detecting cycle at manual force mode					
AF		Auto / manual force mode					
SD		Chip shutdown setting					

INTEGRATION TIME SETTINGS

The time over which the sensor integrates per measurement cycle can be set via the IT bits in the command register 00H.

Command Code IT

The value set for IT defines the integration time and is set via bits 4, 5, and 6 in the command register. From 0 : 0 : 0 to 1 : 0 : 1, six different integration times are selectable. The selectable integration times are shown below:

TABLE 1-2 - COMMAND CODE 00H REGISTER SETTINGS					
BITS SETTINGS		DESCRIPTION	BITS SETTINGS		DESCRIPTION
BIT 7		Default = 0	BIT 3		Default = 0
BIT 6, 5, 4 IT (2 : 0)		(0 : 0 : 0) = 40 ms	BIT 2		0 = not trigger
		(0 : 0 : 1) = 80 ms	TRIG		1 = trigger one time detect cycle
		(0 : 1 : 0) = 160 ms	BIT 1		0 = auto mode
		(0 : 1 : 1) = 320 ms	AF		1 = force mode
		(1 : 0 : 0) = 640 ms	BIT 0		0 = enable color sensor
		(1 : 0 : 1) = 1280 ms	SD		1 = disable color sensor

The sensitivity of the component changes according to the set integration time. With a set integration time of 80 ms, the lux sensitivity of the green channel is 0.12584 lux/step. Choosing a longer integration time will increase the sensitivity accordingly, with the longest integration time of 1280 ms leading to the highest sensitivity of 0.007865 lux/step. The maximal detectable intensity is also derived from the set integration time. The sensitivity and detectable range for each of the selectable integration times is shown in table 2.

TABLE 2 - G CHANNEL RESOLUTION AND MAXIMUM DETECTION RANGE			
IT SETTINGS		G SENSITIVITY	MAX. DETECTABLE LUX
IT (2 : 0)	INTEGRATION TIME		
(0 : 0 : 0)	40 ms	0.25168 lux/step	16 496
(0 : 0 : 1)	80 ms	0.12584 lux/step	8248
(0 : 1 : 0)	160 ms	0.06292 lux/step	4124
(0 : 1 : 1)	320 ms	0.03146 lux/step	2062
(1 : 0 : 0)	640 ms	0.01573 lux/step	1031
(1 : 0 : 1)	1280 ms	0.007865 lux/step	515.4

Designing the VEML6040 RGBW Color Sensor Into Applications

READ OUT OF RGB RESULTS

The VEML6040 stores the 16-bit measurement results from the red, blue, and green channels in the registers 08H to 0AH. Each 16-bit result consists of a low and high byte, stored in the respective 8-bit registers as shown in the table below:

TABLE 3 - READ OUT COMMAND CODE DESCRIPTION			
COMMAND CODE	REGISTER	BIT	DESCRIPTION
08H_L (08H data byte low)	R_DATA_L	7 : 0	00H to FFH, R channel LSB output data
08H_H (08H data byte high)	R_DATA_M	7 : 0	00H to FFH, R channel MSB output data
09H_L (09H data byte low)	G_DATA_L	7 : 0	00H to FFH, G channel LSB output data
09H_H (09H data byte high)	G_DATA_M	7 : 0	00H to FFH, G channel MSB output data
0AH_L (0AH data byte low)	B_DATA_L	7 : 0	00H to FFH, B channel LSB output data
0AH_H (0AH data byte high)	B_DATA_M	7 : 0	00H to FFH, B channel MSB output data
0BH_L (0BH data byte low)	W_DATA_L	7 : 0	00H to FFH, W channel LSB output data
0BH_H (0BH data byte high)	W_DATA_M	7 : 0	00H to FFH, W channel MSB output data

The results will be updated after each measurement cycle, with each color channel being processed in parallel, so that red, green, and blue content of the light source is all measured at the same time. The amount of time taken for the completion of one measurement cycle depends on the IT setting in the command register. In self-timed mode the VEML6040 measures continuously; the host can poll the result registers. To ensure that the value read is current, an integration waiting period should be observed between readings. In “Active Force” mode, the VEML6040 executes one measurement cycle once the TRIG bit has been set. The result is updated after the measurement has completed, which remain in the result registers until a new measurement is made.

VEML6040 “GREEN” CHANNEL USED AS AMBIENT LIGHT SENSOR

The spectral characteristics of the green channel match well to the so-called “Human Eye” $v(\lambda)$ curve (fig. 5). Accordingly, reading the 16-bit green channel result data and multiplying this with the sensitivity factor, for the selected integration time, will lead to an accurate ALS result in lux. The lux sensitivity for every given integration time is shown in table 2.

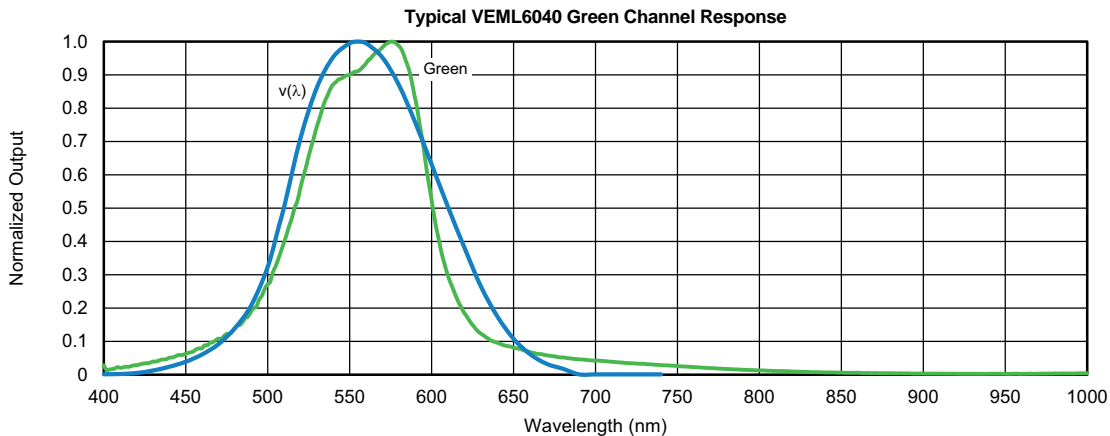

Fig. 5 - Normalized Green Channel Responsivity vs. Wavelength

The corresponding ALS lux level is as follows: $lux = G_DATA \times sensitivity$.

Example:

For a selected integration time of 40 ms, where sensitivity is 0.25168 lux/count multiplied with a 16-bit green data value of 3793 counts (shown in fig. 5), $ALS (lux) = 3793 \times 0.25168 = 954.62 lux$.

For a selected integration time of 80 ms, the sensitivity is 0.12584 lux/count. If the 16-bit green data value is 15 024, the $ALS (lux) = 15\ 024 \times 0.12584 = 1890.62 lux$.

Designing the VEML6040 RGBW Color Sensor Into Applications

The output of each channel is seen to be linear over the different integration times.

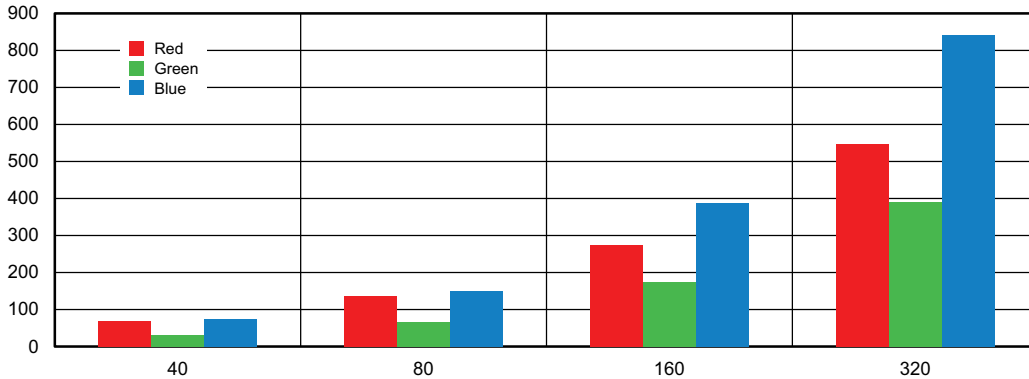

Fig. 6 - Linearity of Integration Times

CORRELATED COLOR TEMPERATURE (CCT)

Another major application of an RGB sensor is to sense the correlated color temperature (CCT). This information can then be used in a feedback system to control a light source, such as a television backlight or an LED array. This can help to maintain the light sources' output with reference to drifts associated with aging and temperature changes. Ambient light conditions in a room may also be monitored, so that backlights can be adjusted to make the screen appear more appealing to the human eye. The procedure for calculating the CCT from the sensors' raw RGB channels is explained below.

XYZ TRISTIMULUS VALUES AND THE COLOR GAMUT

In order to help define a light source to specific common parameters, the International Commission on Illumination (CIE) has defined a color space called the XYZ color space. These XYZ values are called the "tristimulus" values. The color space calls upon a set of specified spectral sensitivity functions, called the color matching functions, from which the tristimulus values are derived. The tristimulus values are arrived at by integrating over the visible spectrum. The color matching functions and the corresponding tristimulus values are shown below:

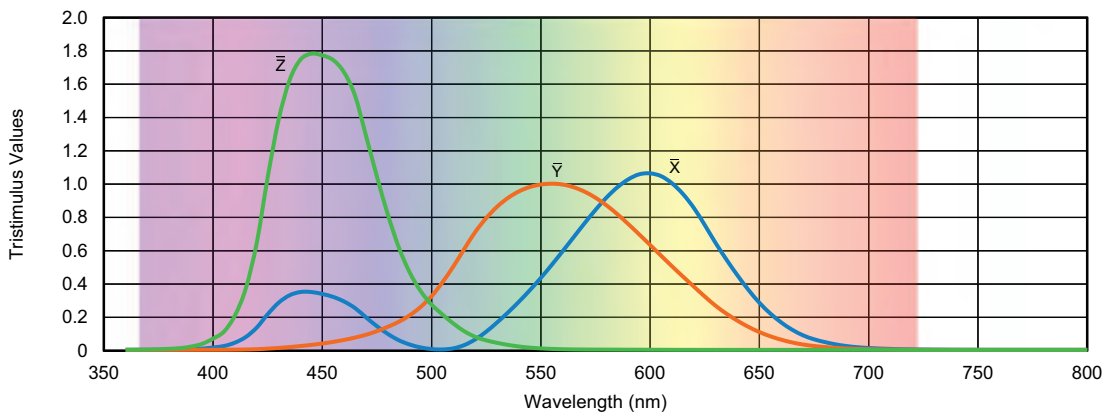

Fig. 7 - Color Matching Functions

$$X = \int_{360}^{780} \bar{X}(\lambda)d\lambda, \quad Y = \int_{360}^{780} \bar{Y}(\lambda)d\lambda, \quad Z = \int_{360}^{780} \bar{Z}(\lambda)d\lambda$$

Designing the VEML6040 RGBW Color Sensor Into Applications

The chromaticity coordinates (x, y) values can then be derived from the normalized XYZ values. This allows the color gamut (CIE 1931 chromaticity diagram) to be used to arrive at the color of the light and calculate the color temperature, for example, by using the McCamy formula. The process of calculating the CCT from the RGB sensor values is described in the next section. The color gamut and the corresponding equations to arrive at the (x, y) coordinates are shown below.

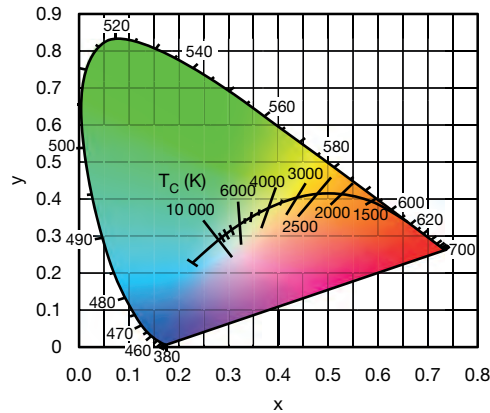

Fig. 8 - The CIE1931 (x, y) Chromaticity Space, also Showing the Chromaticities of Black-Body Light Sources of Various Temperatures (Planckian Locus), and Lines of Constant Correlated Color Temperature

$$y = \frac{Y}{X + Y + Z}$$

$$x = \frac{X}{X + Y + Z}$$

When converting between the XYZ color space and the xyY color space, the Y value (illuminance) is simply kept the same:

$$Y = Y$$

Designing the VEML6040 RGBW Color Sensor Into Applications

USING THE VEML6040 TO CALCULATE THE CCT (McCAMY FORMULA)

In order to calculate CCT values from the RGB values (counts) that are read by the VEML6040, the following steps can be taken:

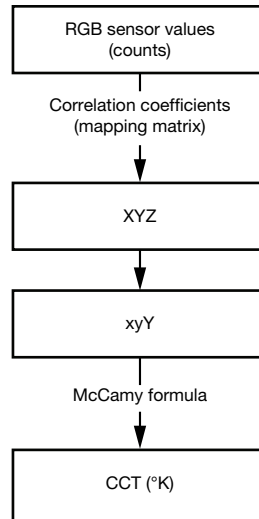

As indicated by the first step, a so-called mapping matrix is required to convert the RGB values to XYZ values. The coefficients in this matrix map the RGB sensor values to the defined color matching functions, to then accurately arrive at the XYZ tristimulus values. Once the correlation coefficients of the mapping matrix are found, the following equation can be used to arrive at the XYZ values:

$$\begin{bmatrix} X \\ Y \\ Z \end{bmatrix} = \begin{bmatrix} M_1 & M_2 & M_3 \\ M_4 & M_5 & M_6 \\ M_7 & M_8 & M_9 \end{bmatrix} \times \begin{bmatrix} R \\ G \\ B \end{bmatrix}$$

Where $\begin{bmatrix} M_1 & M_2 & M_3 \\ M_4 & M_5 & M_6 \\ M_7 & M_8 & M_9 \end{bmatrix}$ is the mapping matrix and $\begin{bmatrix} R \\ G \\ B \end{bmatrix}$ are the values read from the sensor.



Designing the VEML6040 RGBW Color Sensor Into Applications

CALCULATING THE MAPPING MATRIX

In order to get accurate results for the calculated XYZ values, accurate correlation coefficients need to be derived to fill the mapping matrix. This is done through a calibration procedure where values read from the sensor are mapped to xyY values measured by a reference chroma meter or lux meter (e.g. Minolta CL-200). This is done over a range of different light sources in order to allow for a broad transformation. The light sources chosen for the calibration should be close enough to the desirable limits that are to be measured, as well as a light source that is very close to the conditions the application will be exposed to. Accurate results can be found by using at least three light sources. Typical choices here are:

- “A” light or 60 W incandescent - this light source has high IR content
- 6500 K compact fluorescent for cool color temperature
- 2700 K compact fluorescent for warm color temperature

The measurements taken during the calibration process are then used to populate the matrices of the following equation, to then arrive at the correlation coefficients matrix:

$$\text{Corr_Coeff.} = \underbrace{\begin{bmatrix} X_{60\text{ W}} & X_{2700\text{ CF}} & X_{6700\text{ CF}} \\ Y_{60\text{ W}} & Y_{2700\text{ CF}} & Y_{6500\text{ CF}} \\ Z_{60\text{ W}} & Z_{2700\text{ CF}} & Z_{6500\text{ CF}} \end{bmatrix}}_{\text{Values from chroma meter}} \times \underbrace{\begin{bmatrix} R_{60\text{ W}} & R_{2700\text{ CF}} & R_{6700\text{ CF}} \\ G_{60\text{ W}} & G_{2700\text{ CF}} & G_{6500\text{ CF}} \\ B_{60\text{ W}} & B_{2700\text{ CF}} & B_{6500\text{ CF}} \end{bmatrix}}_{\text{Counts from VEML6040}}^{-1}$$

The calibration procedure is conducted as follows:

- Place the sensor and reference chroma meter side by side, so that they are exposed to the same light conditions throughout the calibration
- Warm up illuminant “A” light source to a stable brightness and color temperature condition. Use the chroma meter to measure the Y, x, and y value of the illuminant “A” light source and use the VEML6040 to make a measurement, reading out the red, green, and blue channel
- Use these values to populate the first column in both matrices
- Warm up the 6500 K light source to a stable brightness and color temperature condition. Again take note of the Y, x, and y values from the chroma meter and the red, green, and blue results from the VEML6040
- Use these values to populate the second column in both matrices
- Warm up the 2700 K light source to a stable brightness and color temperature. Again take note of the Y, x, and y values from the chroma meter and the red, green, and blue results from the VEML6040
- Use these values to populate the third column in both matrices

Now that the matrices are complete, the equation can be solved and the correlation coefficient can be found. When the sensor is exposed to just typical open-air values, the correlation coefficients were found to be as follows:

$$\text{Corr_Coeff.} = \begin{bmatrix} 0.048403 & 0.183633 & -0.253589 \\ 0.022916 & 0.176388 & -0.183205 \\ -0.077436 & 0.124541 & 0.032081 \end{bmatrix}$$

This can then be plugged into the XYZ equation to give the following:

$$\begin{bmatrix} X \\ Y \\ Z \end{bmatrix} = \begin{bmatrix} 0.048403 & 0.183633 & -0.253589 \\ 0.022916 & 0.176388 & -0.183205 \\ -0.077436 & 0.124541 & 0.032081 \end{bmatrix} \times \begin{bmatrix} R \\ G \\ B \end{bmatrix}$$



Designing the VEML6040 RGBW Color Sensor Into Applications

The same calibration procedure was followed with different light sources, giving the following coefficients:

- “A” light or 60 W incandescent - this light source has high IR content
- 2700 K compact fluorescent for warm color temperature
- 5000 K white LED for cool color temperature

$$\text{Corr_Coeff.} = \begin{bmatrix} -0.023249 & 0.291014 & -0.364880 \\ -0.042799 & 0.272148 & -0.279591 \\ -0.155901 & 0.251534 & -0.076240 \end{bmatrix}$$

CALCULATING THE X, Y VALUES USING THE McCAMY FORMULA TO CALCULATE CCT

Once the XYZ have been found, these can be used to derive the (x, y) coordinates, which then denote a specific color, as depicted on the axes CIE color gamut on page 7. For this the following equations can be used:

$$x = X/(X + Y + Z)$$

$$y = Y/(X + Y + Z)$$

To give a sample calculation, the following RGB values will be used, which were measured with the VEML6040 sensor under the standard room lighting in our lab:

$$\begin{bmatrix} R = 5132 \text{ counts} \\ G = 4279 \text{ counts} \\ B = 2353 \text{ counts} \end{bmatrix}$$

Using the standard correlation matrix stated above and solving for X, Y and Z gives the following

$$\begin{bmatrix} X \\ Y \\ Z \end{bmatrix} = \begin{bmatrix} 0.048403 & 0.183633 & -0.253589 \\ 0.022916 & 0.176388 & -0.183205 \\ -0.077436 & 0.124541 & 0.032081 \end{bmatrix} \times \begin{bmatrix} 5132 \\ 4279 \\ 2353 \end{bmatrix}$$

$$\begin{bmatrix} X \\ Y \\ Z \end{bmatrix} = \begin{bmatrix} 520.11 \\ 520.66 \\ 267.04 \end{bmatrix}$$

Having found the XYZ values, the (x, y) coordinates can be calculated using the equations above:

$$x = 520.11/(520.11 + 520.66 + 267.04) = 0.3977$$

$$y = 520.66/(520.11 + 520.66 + 267.04) = 0.3981$$

Plotting these coordinates on the CIE gamut chart shows that it is a white light source that is close to 4000 Kelvin, which is what we would have expected for our lab light lighting:

APPLICATION NOTE

Designing the VEML6040 RGBW Color Sensor Into Applications

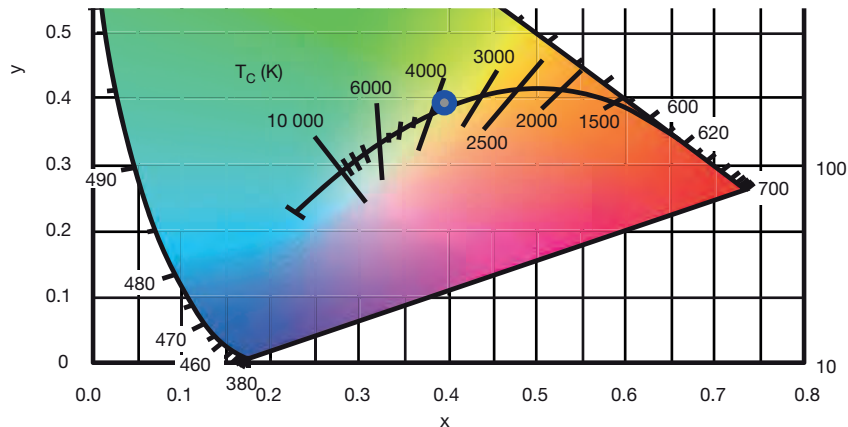

The (x, y) coordinates can now be used to calculate the correlated color temperature (CCT). This can be done via the McCamy formula which is stated as follows:

$$CCT = 449.0 \times n^3 + 3525.0 \times n^2 + 6823.3 \times n + 5520.33$$

Where:

$$n = (x - X_e)/(Y_e - y)$$

X_e and Y_e are constants:

$$X_e = 0.3320$$

$$Y_e = 0.1858$$

For our test this gives the following result for n:

$$n = (0.3977 - 0.3320)/(0.1858 - 0.3981) = -0.3094$$

This can now be inserted into the McCamy formula to calculate the CCT value:

$$CCT = 449.0 \times (-0.3094)^3 + 3525.0 \times (-0.3094)^2 + 6823.3 \times (-0.3094) + 5520.33 = 3733 \text{ K}$$

Designing the VEML6040 RGBW Color Sensor Into Applications

USING THE VEML6040 TO CALCULATE THE CCT (EMPIRICAL APPROACH)

A less accurate but less computationally intensive method of calculating CCT can be found using an empirical approach. This is based on the following estimation, which was arrived at by mapping CCT values calculated from the sensor results to CCT values measured by a chroma meter:

$$CCT = 4278.6 \times CCT_i^{-1.2455}$$

Where:

$$CCT_i = CCT_{i_Raw} + \text{offset}$$

$$CCT_{i_Raw} = \left(\frac{R - B}{G} \right)$$

$$\text{Offset (open air)} = 0.5$$

In open-air conditions the offset = 0.5. Depending on the optical conditions (e.g. cover glass) this offset may change.

VEML6040 SENSOR BOARD AND DEMO SOFTWARE

With the help of the VEML6040 sensor board and the accompanying demo software, it is easy to test the RGB sensor. The six possible integration times are selectable over the GUI (1), as shown in fig. 9. As shown in fig. 10, the output results of the sensor are strictly linear over the integration times. A factor of 2 in the integration time leads to a factor of 2 in the output data counts, shown on the graph and the color results section (3). Depending on the chosen integration time, the measurement rate will be affected accordingly (2).

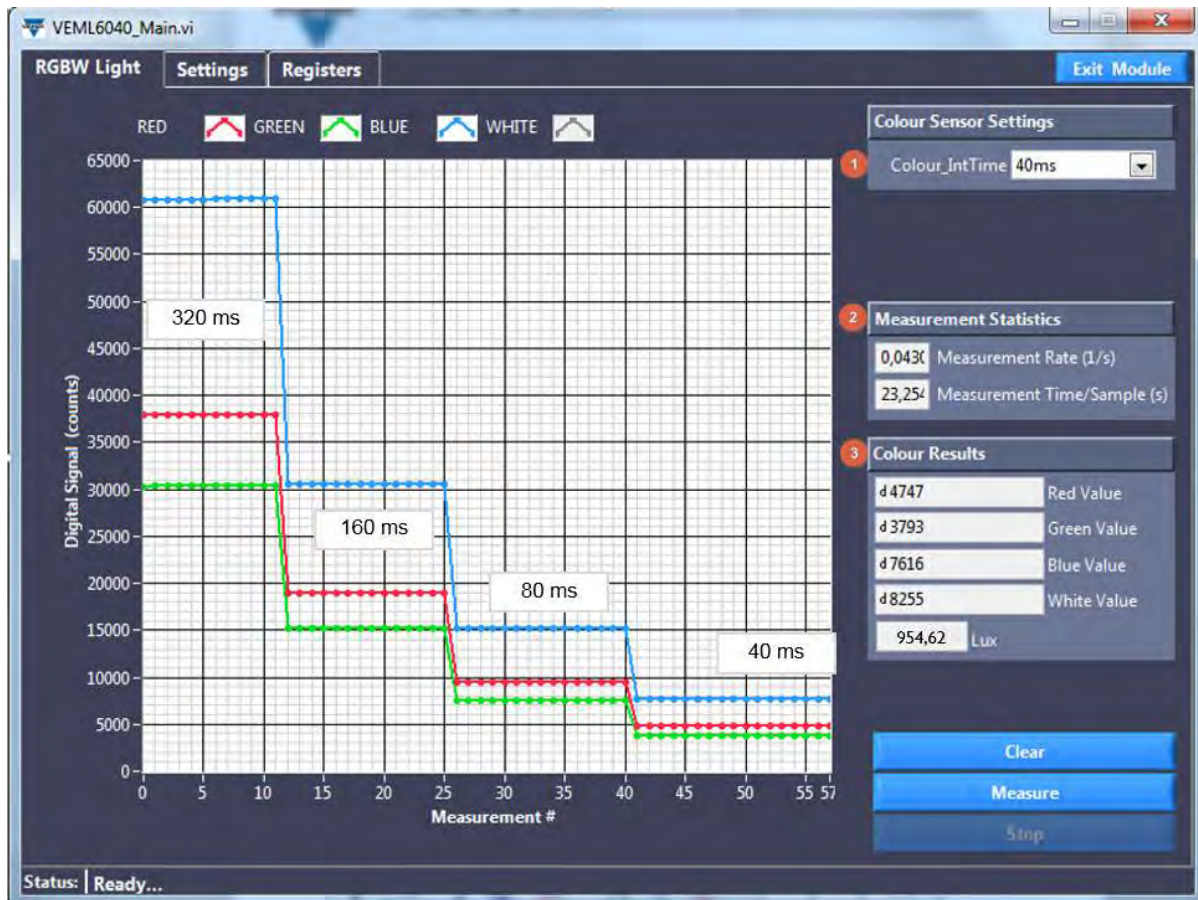

Fig. 9 - Linearity of the Integration Times

Designing the VEML6040 RGBW Color Sensor Into Applications

MECHANICAL CONSIDERATIONS AND WINDOW CALCULATION FOR THE VEML6040

For optimal performance, the window size should be large enough to maximize the light irradiating the sensor. In calculating the window size, the only dimensions that the design engineer needs to consider are the distance from the top surface of the sensor to the outside surface of the window and the size of the window. These dimensions will determine the size of the detection zone.

First, the center of the sensor and center of the window should be aligned.

The VEML6040 has an angle of half sensitivity of about $\pm 55^\circ$, as shown in the figure below.

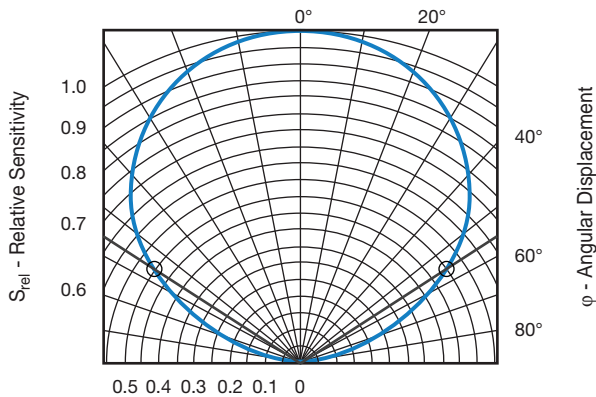

Fig. 10 - Relative Radiant Sensitivity vs. Angular Displacement

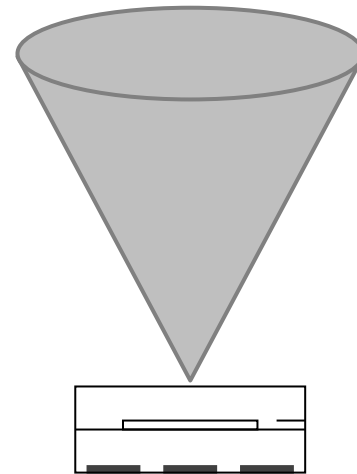

Fig. 11 - Angle of Half Sensitivity: Cone

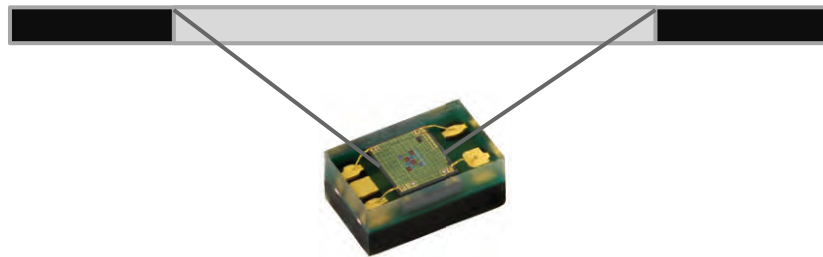

Fig. 12 - Window Above Sensitive Area

Remark:

This wide angle and the placement of the sensor as close as possible to the cover is needed to show good responsivity.

Designing the VEML6040 RGBW Color Sensor Into Applications

The size of the window is simply calculated according to triangular rules. The dimensions of the device, as well as the sensitive area, is shown within the datasheet. Best results are achieved with a known distance below the windows, upper surface and the specified angle below the given window diameter (w).

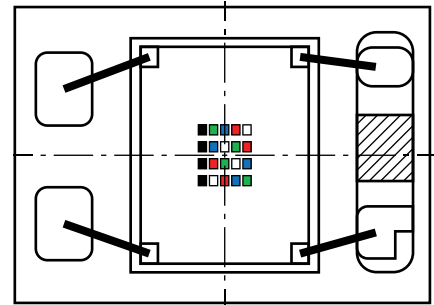
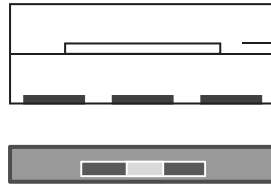
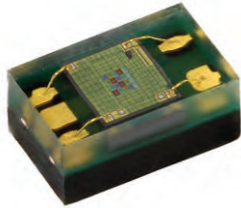

Dimensions (L x W x H in mm): 2.0 x 1.25 x 1.0

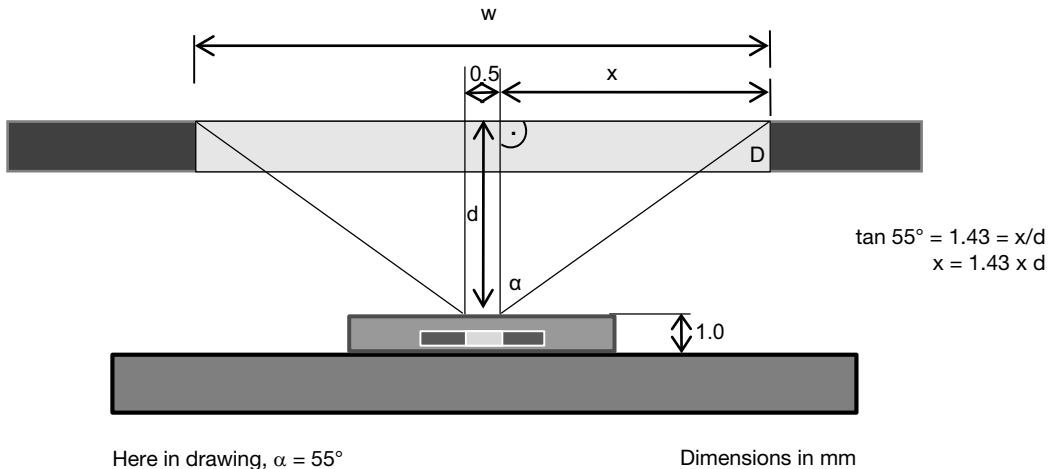

Fig. 13 - Window Area for an Opening Angle of $\pm 55^\circ$

The calculation is then: $\tan \alpha = x/d \rightarrow$ with $\alpha = 55^\circ$ and $\tan 55^\circ = 1.43 = x/d \rightarrow x = 1.43 \times d$
 Then the total width is $w = 0.5 \text{ mm} + 2 \times x$.

$d = 0.5 \text{ mm}$	\rightarrow	$x = 0.72 \text{ mm}$	\rightarrow	$w = 0.5 \text{ mm} + 1.44 \text{ mm}$	$= 1.94 \text{ mm}$
$d = 1.0 \text{ mm}$	\rightarrow	$x = 1.43 \text{ mm}$	\rightarrow	$w = 0.5 \text{ mm} + 2.86 \text{ mm}$	$= 3.36 \text{ mm}$
$d = 1.5 \text{ mm}$	\rightarrow	$x = 2.15 \text{ mm}$	\rightarrow	$w = 0.5 \text{ mm} + 4.30 \text{ mm}$	$= 4.80 \text{ mm}$
$d = 2.0 \text{ mm}$	\rightarrow	$x = 2.86 \text{ mm}$	\rightarrow	$w = 0.5 \text{ mm} + 5.72 \text{ mm}$	$= 6.22 \text{ mm}$
$d = 2.5 \text{ mm}$	\rightarrow	$x = 3.58 \text{ mm}$	\rightarrow	$w = 0.5 \text{ mm} + 7.16 \text{ mm}$	$= 7.66 \text{ mm}$
$d = 3.0 \text{ mm}$	\rightarrow	$x = 4.29 \text{ mm}$	\rightarrow	$w = 0.5 \text{ mm} + 8.58 \text{ mm}$	$= 9.08 \text{ mm}$

Designing the VEML6040 RGBW Color Sensor Into Applications

A smaller window will also be sufficient, although it will reduce the total sensitivity of the sensor.

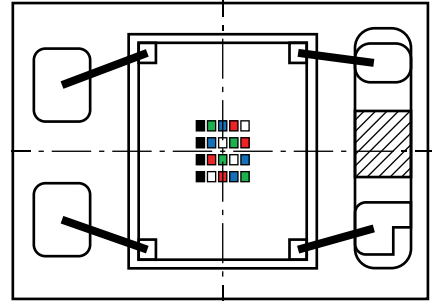
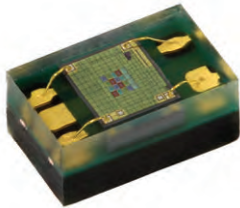

Dimensions (L x W x H in mm): 2.0 x 1.25 x 1.0

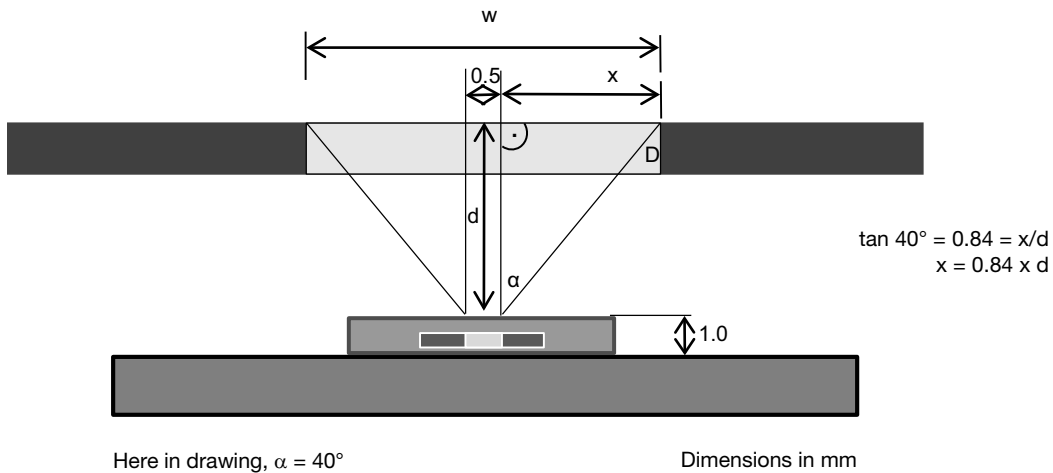

Fig. 14 - Window Area for an Opening Angle of $\pm 40^\circ$

The calculation is then: $\tan \alpha = x/d \rightarrow$ with $\alpha = 40^\circ$ and $\tan 40^\circ = 0.84 = x/d \rightarrow x = 0.84 \times d$
 Then the total width is $w = 0.5 \text{ mm} + 2 \times x$.

$d = 0.5 \text{ mm}$	\rightarrow	$x = 0.42 \text{ mm}$	\rightarrow	$w = 0.5 \text{ mm} + 0.84 \text{ mm}$	$=$	1.34 mm
$d = 1.0 \text{ mm}$	\rightarrow	$x = 0.84 \text{ mm}$	\rightarrow	$w = 0.5 \text{ mm} + 1.68 \text{ mm}$	$=$	2.18 mm
$d = 1.5 \text{ mm}$	\rightarrow	$x = 1.28 \text{ mm}$	\rightarrow	$w = 0.5 \text{ mm} + 2.56 \text{ mm}$	$=$	3.06 mm
$d = 2.0 \text{ mm}$	\rightarrow	$x = 1.68 \text{ mm}$	\rightarrow	$w = 0.5 \text{ mm} + 3.36 \text{ mm}$	$=$	3.86 mm
$d = 2.5 \text{ mm}$	\rightarrow	$x = 2.10 \text{ mm}$	\rightarrow	$w = 0.5 \text{ mm} + 4.20 \text{ mm}$	$=$	4.70 mm
$d = 3.0 \text{ mm}$	\rightarrow	$x = 2.52 \text{ mm}$	\rightarrow	$w = 0.5 \text{ mm} + 5.04 \text{ mm}$	$=$	5.54 mm



Designing the VEML6040 RGBW Color Sensor Into Applications

VEML6040 REFERENCE CODE

```

//-----
// Global definition for VEML6040 registers
//-----
#define VEML6040_SLAVE_ADD 0x10
#define CONF 0x00
#define R_DATA 0x08
#define G_DATA 0x09
#define B_DATA 0x0A
#define W_DATA 0x0B
//-----
// C main function
//-----
void main ()
{
WORD VEML6040_DATA_R;
WORD VEML6040_DATA_G;
WORD VEML6040_DATA_B;
WORD VEML6040_DATA_W;
//-----
// Write Initial Command to VEML6040
// Command Code: 0x00,
// Low Byte 20 (0010:0001)
// IT = 160 ms
// TRIG = No trigger
// AF = Auto mode
// SD = Disable
//
// High Byte 00 (0000:0000)
// Default = 00
// -----
// Shut Down Color Sensor
WriteBytes(VEML6040_SLAVE_ADD, CONF, 0x21, 0x00, 2);
// Enable Color Sensor
WriteBytes(VEML6040_SLAVE_ADD, CONF, 0x20, 0x00, 2);
// Read VEML6040 Data Loop
while (1)
{
Delay(200);
// Read VEML6040 R Channel Data
VEML6040_DATA_R = read_veml6040_data(R_DATA);
// Read VEML6040 G Channel Data
VEML6040_DATA_G = read_veml6040_data(G_DATA);
// Read VEML6040 B Channel Data
VEML6040_DATA_B = read_veml6040_data(B_DATA);
// Read VEML6040 W Channel Data
VEML6040_DATA_W = read_veml6040_data(W_DATA);
}
}

```



Designing the VEML6040 RGBW Color Sensor Into Applications

VEML6040 REFERENCE CODE (continued)

```
//-----  
// FUNCTION NAME: read_veml6040_data  
//  
// DESCRIPTION:  
//-----  
WORD read_veml6040_data(WORD channel)  
{  
  BYTE buff[2];  
  BYTE lsb, msb;  
  WORD channel_data;  
  ReadBytes(VEML6040_SLAVE_ADD, channel, buff, 2);  
  lsb = buff[0];  
  msb = buff[1];  
  channel_data = ((WORD)msb << 8) | (WORD)lsb;  
  return channel_data;  
}
```

VEML6040 SENSOR BOARD AND DEMO SOFTWARE

The small blue VEML6040 sensor board is compatible with the SensorXplorer™.
Please also see: www.vishay.com/optoelectronic/SensorXplorer.