

RF PIN Diodes - Dual, Common Cathode in SOT-323

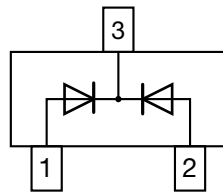

FEATURES

- High voltage current controlled RF resistor
- Small diode capacitance
- AEC-Q101 qualified available
- Low series inductance
- Low forward resistance
- Material categorization:
for definitions of compliance please see www.vishay.com/doc?99912

RoHS
COMPLIANT

LINKS TO ADDITIONAL RESOURCES



DESCRIPTION

Characterized by low reverse capacitance the PIN diode BAR64-05W was designed for RF signal switching and tuning. As a function of the forward bias current the forward resistance (RF) can be adjusted over a wide range. A long carrier life time offers low signal distortion for signals over 10 MHz up to 3 GHz. Typical applications for these PIN diodes are switches and attenuators in wireless, mobile, and TV-systems.

APPLICATIONS

- For frequencies up to 3 GHz
- RF-signal tuning
- Signal attenuator and switches
- Mobile, wireless, and TV-applications

ORDERING INFORMATION

PART NUMBER	ENVIRONMENTAL AND QUALITY CODE				PACKAGING CODE		ORDERING CODE (EXAMPLE)
	AEC-Q101 QUALIFIED	RoHS-COMPLIANT + LEAD (Pb)-FREE TERMINATIONS	TIN PLATED	REVISION CODE	3K PER 7" REEL (8 mm TAPE) 15K/BOX = MOQ	10K PER 13" REEL (8 mm TAPE) 10K/BOX = MOQ	
BAR64-05W-		E	3	-	08		BAR64-05W-E3-08
BAR64-05W-	H	E	3	-	08		BAR64-05W-HE3-08
BAR64-05W-		E	3	-		18	BAR64-05W-E3-18
BAR64-05W-	H	E	3	-		18	BAR64-05W-HE3-18

ABSOLUTE MAXIMUM RATINGS ($T_{amb} = 25\text{ }^{\circ}\text{C}$, unless otherwise specified)

PART	TEST CONDITION	SYMBOL	VALUE	UNIT
Reverse voltage		V_R	100	V
Forward continuous current		I_F	100	mA
ESD-immunity	HBM (Human Body Model) acc. AEC-Q101-001	V_{ESD}	750	V

PACKAGE DATA

DEVICE NAME	PACKAGE NAME	TYPE CODE	WEIGHT	MOLDING COMPOUND FLAMMABILITY RATING	MOISTURE SENSITIVITY LEVEL	SOLDERING CONDITIONS
BAR64-05W	SOT-323	R64	5.65 mg	UL 94 V-0	MSL level 1 (according J-STD-020)	Peak temperature max. 260 °C

THERMAL CHARACTERISTICS ($T_{amb} = 25\text{ }^{\circ}\text{C}$, unless otherwise specified)

PARAMETER	TEST CONDITION	SYMBOL	VALUE	UNIT
Junction temperature		T_j	150	°C
Storage temperature range		T_{stg}	-65 to +150	°C
Operating temperature range		T_{op}	-55 to +125	°C



ELECTRICAL CHARACTERISTICS (T _{amb} = 25 °C, unless otherwise specified)						
PARAMETER	TEST CONDITION	SYMBOL	MIN.	TYP.	MAX.	UNIT
Forward voltage	I _F = 50 mA	V _F	-	-	1.1	V
Reverse voltage	I _R = 10 μA	V _R	100	-	-	V
Reverse current	V _R = 50 V	I _R	-	-	0.05	μA
Diode capacitance	f = 1 MHz, V _R = 0 V	C _D	-	0.5	-	pF
	f = 1 MHz, V _R = 1 V	C _D	-	0.37	0.5	pF
	f = 1 MHz, V _R = 20 V	C _D	-	0.23	0.35	pF
Differential forward resistance	f = 100 MHz, I _F = 1 mA	r _f	-	10	20	Ω
	f = 100 MHz, I _F = 10 mA	r _f	-	2	3.8	Ω
	f = 100 MHz, I _F = 100 mA	r _f	-	0.8	1.35	Ω
Charge carrier lifetime	I _F = 10 mA, I _R = 6 mA, i _R = 3 mA	t _{rr}	-	1.4	-	μs
Series inductance		L _S	-	1.4	-	nH

TYPICAL CHARACTERISTICS (T_{amb} = 25 °C, unless otherwise specified)

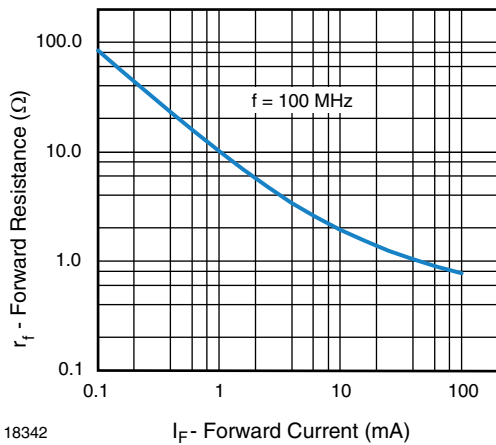

Fig. 1 - Forward Resistance vs. Forward Current

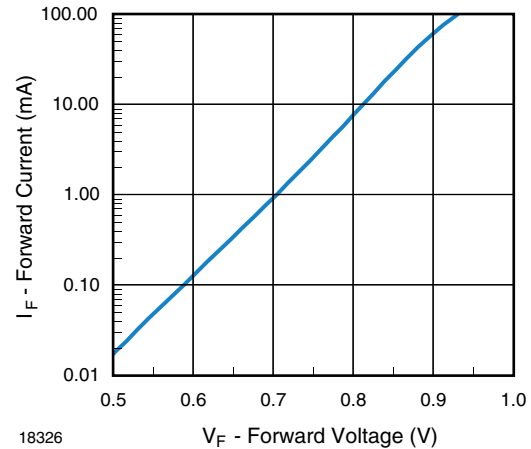

Fig. 3 - Forward Current vs. Forward Voltage

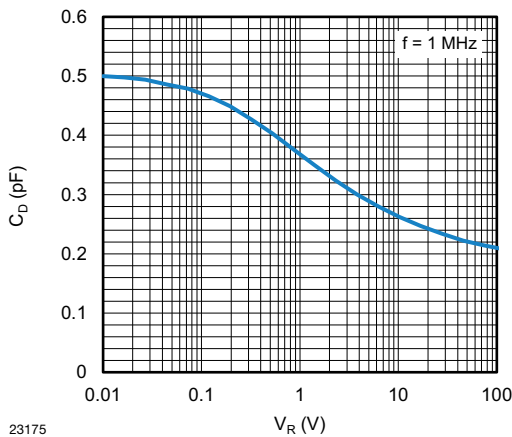

Fig. 2 - Diode Capacitance vs. Reverse Voltage

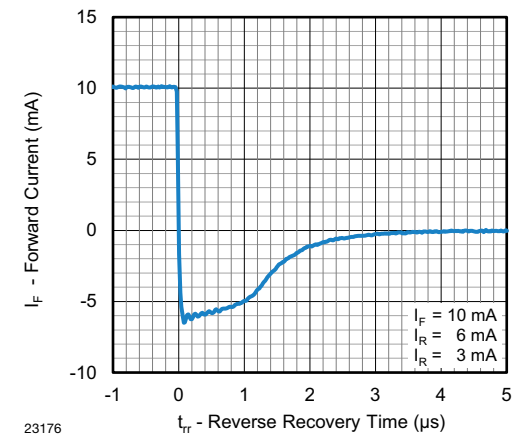
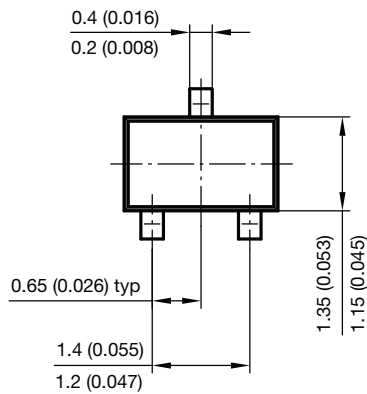
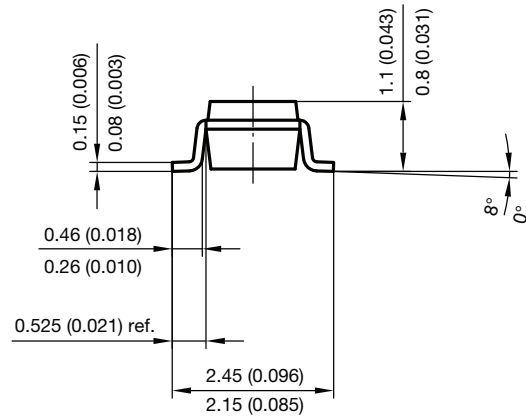
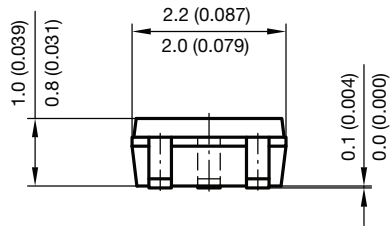

Fig. 4 - Typical Charge Recovery Curve



PACKAGE DIMENSIONS in millimeters (inches): SOT-323



foot print recommendation:

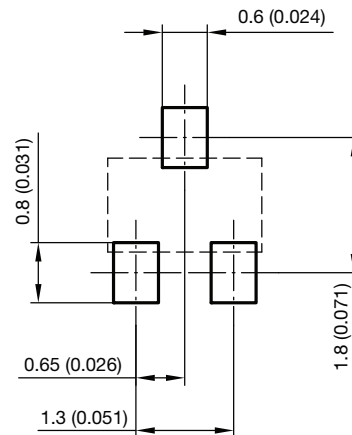

Document no.: 6.541-5040.02-4
Rev. 1 - Date: 06. April 2010
21113

ORIENTATION IN CARRIER TAPE SOT-323

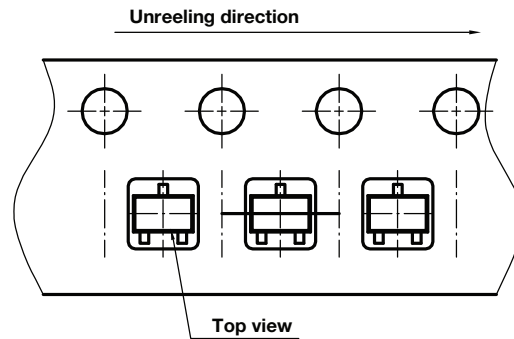

Document no.: S8-V-3717.08-002 (4)
 Created - Date: 09. Feb. 2010
 22761

CARRIER TAPE SOT-323

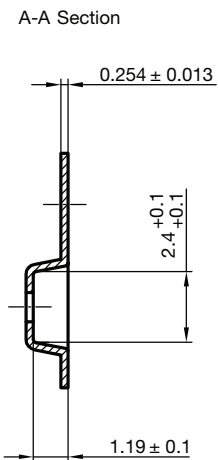
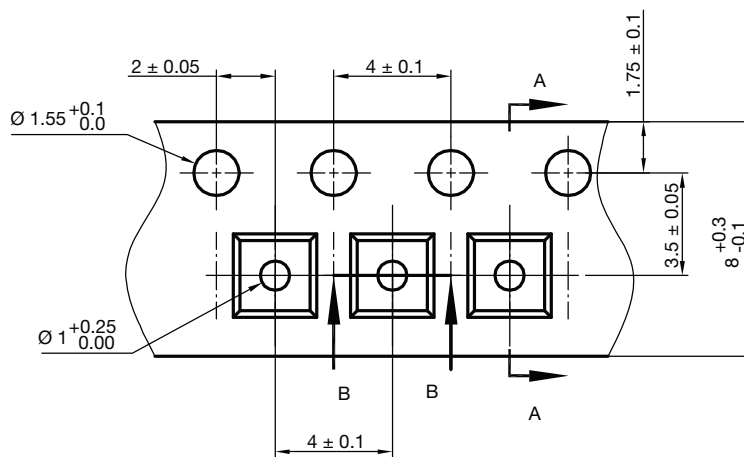

B-B Section

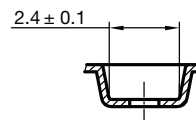

Document no.: S8-V-3717.08-002 (4)
 Created - Date: 09. Feb. 2010
 22762



Disclaimer

ALL PRODUCT, PRODUCT SPECIFICATIONS AND DATA ARE SUBJECT TO CHANGE WITHOUT NOTICE TO IMPROVE RELIABILITY, FUNCTION OR DESIGN OR OTHERWISE.

Vishay Intertechnology, Inc., its affiliates, agents, and employees, and all persons acting on its or their behalf (collectively, "Vishay"), disclaim any and all liability for any errors, inaccuracies or incompleteness contained in any datasheet or in any other disclosure relating to any product.

Vishay makes no warranty, representation or guarantee regarding the suitability of the products for any particular purpose or the continuing production of any product. To the maximum extent permitted by applicable law, Vishay disclaims (i) any and all liability arising out of the application or use of any product, (ii) any and all liability, including without limitation special, consequential or incidental damages, and (iii) any and all implied warranties, including warranties of fitness for particular purpose, non-infringement and merchantability.

Statements regarding the suitability of products for certain types of applications are based on Vishay's knowledge of typical requirements that are often placed on Vishay products in generic applications. Such statements are not binding statements about the suitability of products for a particular application. It is the customer's responsibility to validate that a particular product with the properties described in the product specification is suitable for use in a particular application. Parameters provided in datasheets and / or specifications may vary in different applications and performance may vary over time. All operating parameters, including typical parameters, must be validated for each customer application by the customer's technical experts. Product specifications do not expand or otherwise modify Vishay's terms and conditions of purchase, including but not limited to the warranty expressed therein.

Hyperlinks included in this datasheet may direct users to third-party websites. These links are provided as a convenience and for informational purposes only. Inclusion of these hyperlinks does not constitute an endorsement or an approval by Vishay of any of the products, services or opinions of the corporation, organization or individual associated with the third-party website. Vishay disclaims any and all liability and bears no responsibility for the accuracy, legality or content of the third-party website or for that of subsequent links.

Except as expressly indicated in writing, Vishay products are not designed for use in medical, life-saving, or life-sustaining applications or for any other application in which the failure of the Vishay product could result in personal injury or death. Customers using or selling Vishay products not expressly indicated for use in such applications do so at their own risk. Please contact authorized Vishay personnel to obtain written terms and conditions regarding products designed for such applications.

No license, express or implied, by estoppel or otherwise, to any intellectual property rights is granted by this document or by any conduct of Vishay. Product names and markings noted herein may be trademarks of their respective owners.