

# HEXFRED®

## Ultra Fast Soft Recovery Diode, 320 A

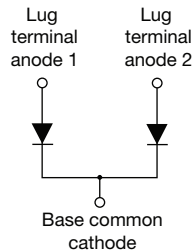

TO-244

**FEATURES**

- Very low  $Q_{rr}$  and  $t_{rr}$
- UL approved file E222165
- Designed and qualified for industrial level
- Material categorization: for definitions of compliance please see [www.vishay.com/doc?99912](http://www.vishay.com/doc?99912)

**RoHS**  
COMPLIANT

**BENEFITS**

- Reduced RFI and EMI
- Reduced snubbing

**DESCRIPTION / APPLICATIONS**

HEXFRED® diodes are optimized to reduce losses and EMI/RFI in high frequency power conditioning systems. An extensive characterization of the recovery behavior for different values of current, temperature and  $di_F/dt$  simplifies the calculations of losses in the operating conditions. The softness of the recovery eliminates the need for a snubber in most applications. These devices are ideally suited for power converters, motors drives and other applications where switching losses are significant portion of the total losses.

**PRIMARY CHARACTERISTICS**

$I_{F(AV)}$	320 A
$V_R$	400 V
$I_{F(DC)}$ at $T_C$	255 A at 85 °C
Package	TO-244
Circuit configuration	Two diodes common cathode

**ABSOLUTE MAXIMUM RATINGS**

PARAMETER	SYMBOL	TEST CONDITIONS	MAX.	UNITS
Cathode to anode voltage	$V_R$		400	V
Continuous forward current	$I_F$	$T_C = 25\text{ °C}$	420	A
		$T_C = 85\text{ °C}$	255	
		$T_C = 115\text{ °C}$	160	
Single pulse forward current	$I_{FSM}$	Limited by junction temperature	1200	
Non-repetitive avalanche energy	$E_{AS}$	$L = 100\ \mu\text{H}$ , duty cycle limited by maximum $T_J$	1.4	mJ
Maximum power dissipation	$P_D$	$T_C = 25\text{ °C}$	625	W
		$T_C = 100\text{ °C}$	250	
Operating junction and storage temperature range	$T_J, T_{Stg}$		-55 to +150	°C

**ELECTRICAL SPECIFICATIONS ( $T_J = 25\text{ °C}$  unless otherwise specified)**

PARAMETER	SYMBOL	TEST CONDITIONS	MIN.	TYP.	MAX.	UNITS
Cathode to anode breakdown voltage	$V_{BR}$	$I_R = 100\ \mu\text{A}$	400	-	-	V
Maximum forward voltage	$V_{FM}$	$I_F = 160\text{ A}$	-	1.10	1.35	
		$I_F = 320\text{ A}$	-	1.30	1.54	
		$I_F = 160\text{ A}, T_J = 125\text{ °C}$	-	1.00	1.20	
Maximum reverse leakage current	$I_{RM}$	$T_J = 125\text{ °C}, V_R = 400\text{ V}$	See fig. 2	0.9	3	mA
Junction capacitance	$C_T$	$V_R = 200\text{ V}$	See fig. 3	370	500	pF
Series inductance	$L_S$	From top of terminal hole to mounting plane	-	5.0	-	nH



DYNAMIC RECOVERY CHARACTERISTICS (T <sub>J</sub> = 25 °C unless otherwise specified)						
PARAMETER	SYMBOL	TEST CONDITIONS	MIN.	TYP.	MAX.	UNITS
Reverse recovery time See fig. 5	t <sub>rr</sub>	I <sub>F</sub> = 1.0 A, di <sub>F</sub> /dt = 200 A/μs, V <sub>R</sub> = 30 V	-	45	-	ns
		T <sub>J</sub> = 25 °C	-	90	140	
		T <sub>J</sub> = 125 °C	-	290	440	
Peak recovery current See fig. 6	I <sub>RRM</sub>	T <sub>J</sub> = 25 °C	-	8.7	20	A
		T <sub>J</sub> = 125 °C	-	18	30	
Reverse recovery charge See fig. 7	Q <sub>rr</sub>	T <sub>J</sub> = 25 °C	-	420	1100	nC
		T <sub>J</sub> = 125 °C	-	2600	7000	
Peak rate of recovery current See fig. 8	di <sub>(rec)</sub> /dt	T <sub>J</sub> = 25 °C	-	300	-	A/μs
		T <sub>J</sub> = 125 °C	-	280	-	

THERMAL - MECHANICAL SPECIFICATIONS						
PARAMETER	SYMBOL	MIN.	TYP.	MAX.	UNITS	
Maximum junction and storage temperature range	T <sub>J</sub> , T <sub>Stg</sub>	- 55	-	150	°C	
Thermal resistance, junction to case	per leg	-	-	0.19	°C/W K/W	
	per module	-	-	0.095		
Typical thermal resistance, case to heatsink	R <sub>thCS</sub>	-	0.10	-		
Weight		-	68	-	g	
		-	2.4	-	oz.	
Mounting torque (1)		30 (3.4)	-	40 (4.6)	lbf · in (N · m)	
	center hole	12 (1.4)	-	18 (2.1)		
Terminal torque		30 (3.4)	-	40 (4.6)		
Vertical pull		-	-	80	lbf · in	
2" lever pull		-	-	35		

**Note**

(1) Mounting surface must be smooth, flat, free of burrs or other protrusions. Apply a thin even film or thermal grease to mounting surface. Gradually tighten each mounting bolt in 5 to 10 lbf · in steps until desired or maximum torque limits are reached.

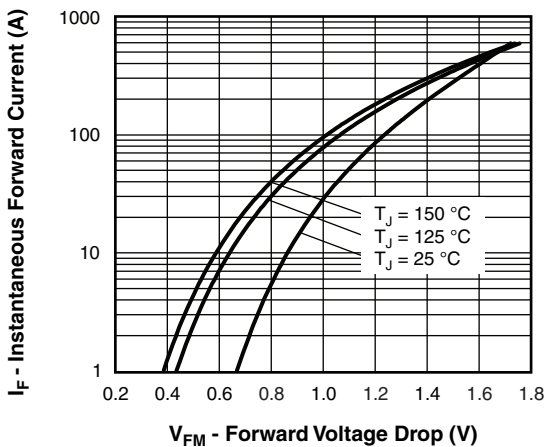

Fig. 1 - Maximum Forward Voltage Drop vs. Instantaneous Forward Current (Per Leg)

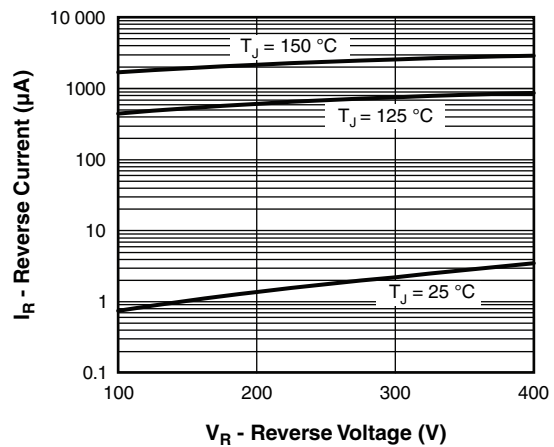

Fig. 2 - Typical Reverse Current vs. Reverse Voltage (Per Leg)

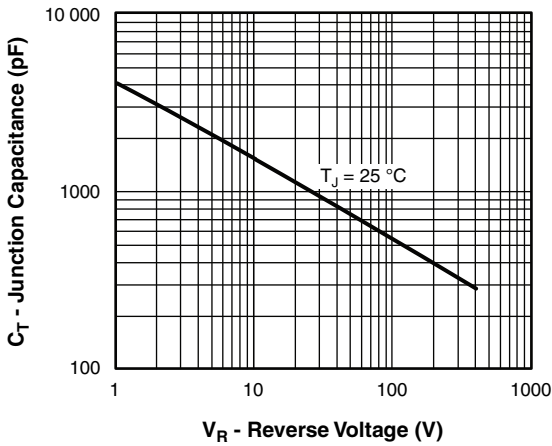

Fig. 3 - Typical Junction Capacitance vs. Reverse Voltage (Per Leg)

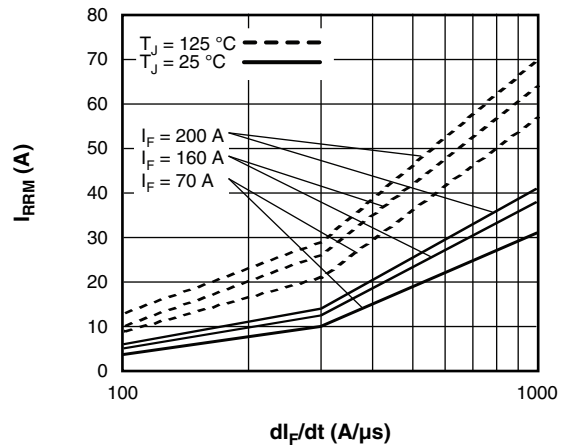

Fig. 6 - Typical Recovery Current vs.  $di_F/dt$  (Per Leg)

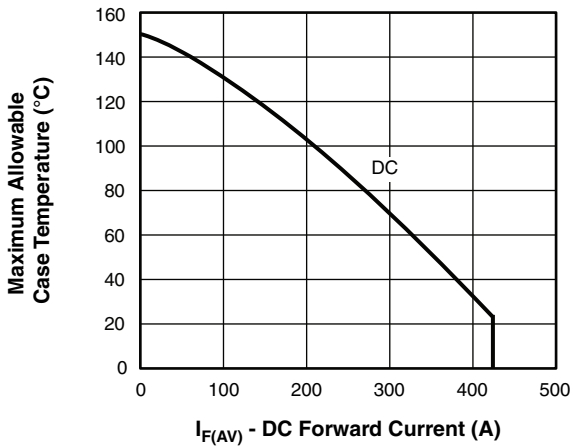

Fig. 4 - Maximum Allowable Case Temperature vs. DC Forward Current (Per Leg)

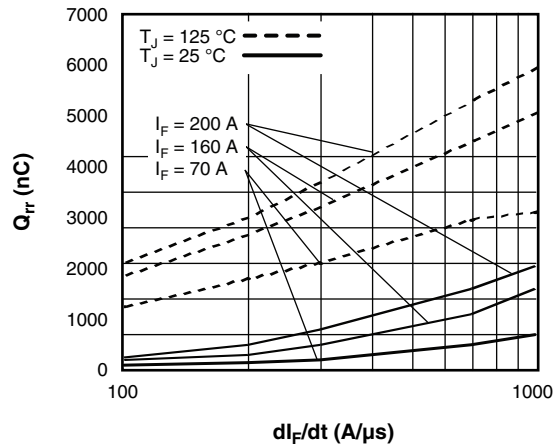

Fig. 7 - Typical Stored Charge vs.  $di_F/dt$  (Per Leg)

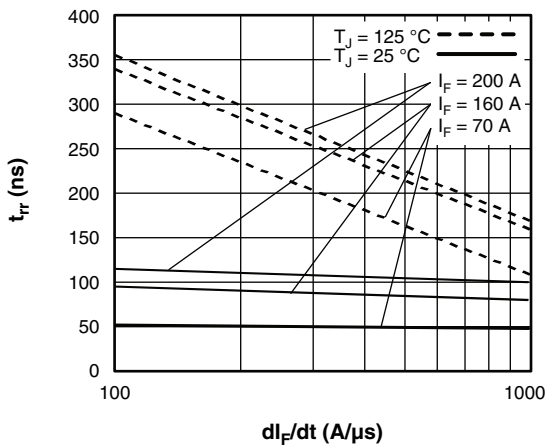

Fig. 5 - Typical Reverse Recovery Time vs.  $di_F/dt$  (Per Leg)

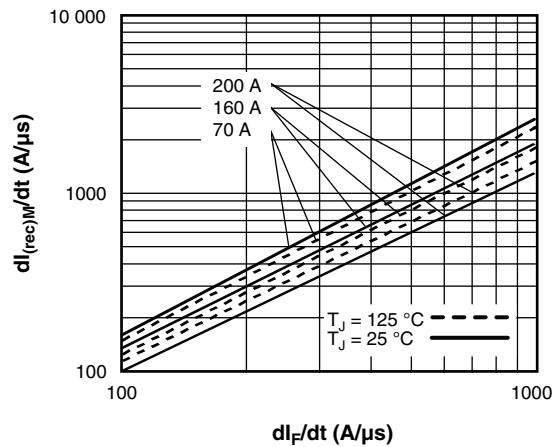

Fig. 8 - Typical  $di_{(rec)M}/dt$  vs.  $di_F/dt$  (Per Leg)

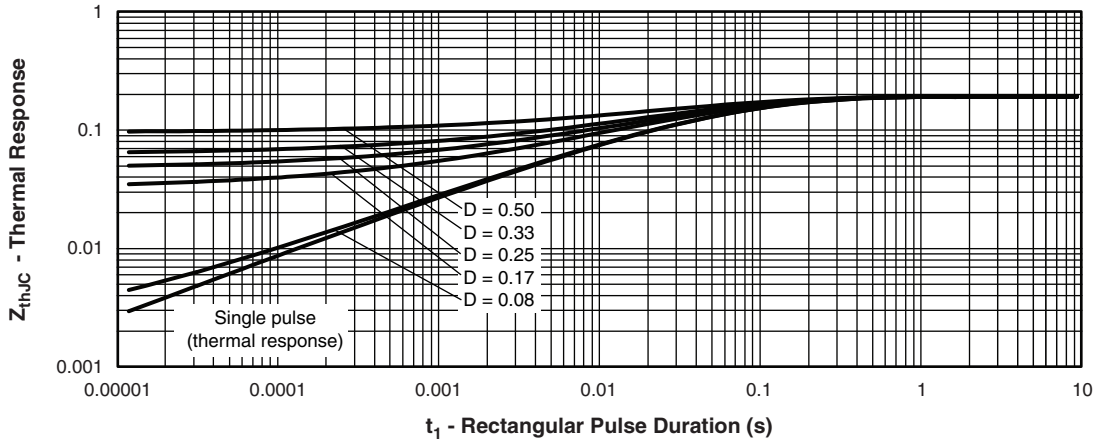

Fig. 9 - Maximum Thermal Impedance  $Z_{thJC}$  Characteristics (Per Leg)

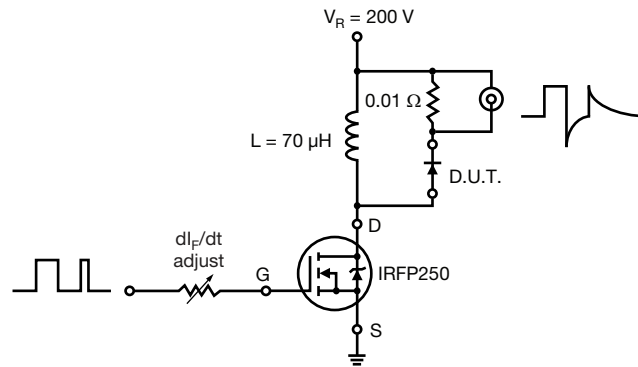
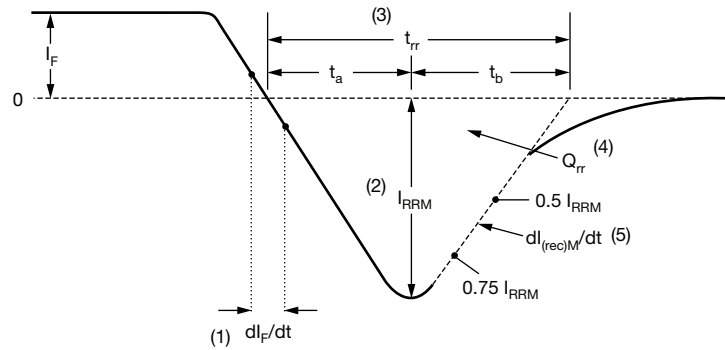

Fig. 10 - Reverse Recovery Parameter Test Circuit



- (1)  $dI_F/dt$  - rate of change of current through zero crossing
- (2)  $I_{RRM}$  - peak reverse recovery current
- (3)  $t_{rr}$  - reverse recovery time measured from zero crossing point of negative going  $I_F$  to point where a line passing through  $0.75 I_{RRM}$  and  $0.50 I_{RRM}$  extrapolated to zero current.
- (4)  $Q_{rr}$  - area under curve defined by  $t_{rr}$  and  $I_{RRM}$
- (5)  $dI_{(rec)M}/dt$  - peak rate of change of current during  $t_b$  portion of  $t_{rr}$

$$Q_{rr} = \frac{t_{rr} \times I_{RRM}}{2}$$

Fig. 11 - Reverse Recovery Waveform and Definitions

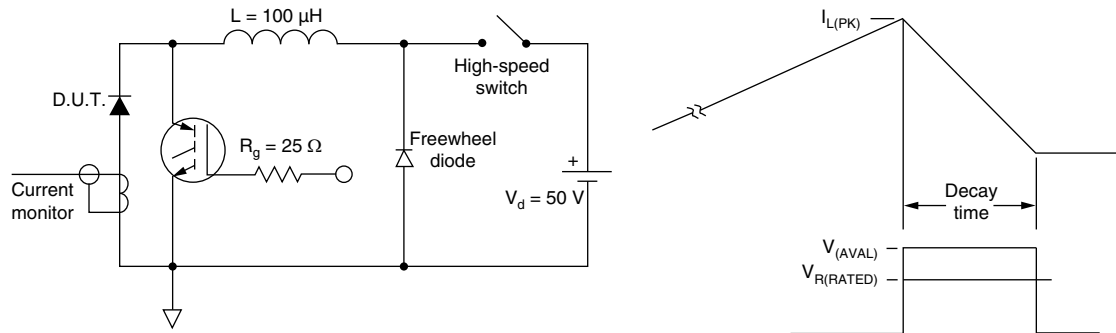

Fig. 12 - Avalanche Test Circuit and Waveforms

**ORDERING INFORMATION TABLE**

Device code	VS-	HFA	320	NJ	40	C	PbF
	1	2	3	4	5	6	7
	1	2	3	4	5	6	7
	1	2	3	4	5	6	7

- 1 - Vishay Semiconductors product
- 2 - HEXFRED® family, electron irradiated
- 3 - Average current rating
- 4 - NJ = TO-244
- 5 - Voltage rating (400 V)
- 6 - C = common cathode
- 7 - Lead (Pb)-free

**LINKS TO RELATED DOCUMENTS**

Dimensions	<a href="http://www.vishay.com/doc?95021">www.vishay.com/doc?95021</a>
------------	--





## Disclaimer

ALL PRODUCT, PRODUCT SPECIFICATIONS AND DATA ARE SUBJECT TO CHANGE WITHOUT NOTICE TO IMPROVE RELIABILITY, FUNCTION OR DESIGN OR OTHERWISE.

Vishay Intertechnology, Inc., its affiliates, agents, and employees, and all persons acting on its or their behalf (collectively, "Vishay"), disclaim any and all liability for any errors, inaccuracies or incompleteness contained in any datasheet or in any other disclosure relating to any product.

Vishay makes no warranty, representation or guarantee regarding the suitability of the products for any particular purpose or the continuing production of any product. To the maximum extent permitted by applicable law, Vishay disclaims (i) any and all liability arising out of the application or use of any product, (ii) any and all liability, including without limitation special, consequential or incidental damages, and (iii) any and all implied warranties, including warranties of fitness for particular purpose, non-infringement and merchantability.

Statements regarding the suitability of products for certain types of applications are based on Vishay's knowledge of typical requirements that are often placed on Vishay products in generic applications. Such statements are not binding statements about the suitability of products for a particular application. It is the customer's responsibility to validate that a particular product with the properties described in the product specification is suitable for use in a particular application. Parameters provided in datasheets and / or specifications may vary in different applications and performance may vary over time. All operating parameters, including typical parameters, must be validated for each customer application by the customer's technical experts. Product specifications do not expand or otherwise modify Vishay's terms and conditions of purchase, including but not limited to the warranty expressed therein.

Hyperlinks included in this datasheet may direct users to third-party websites. These links are provided as a convenience and for informational purposes only. Inclusion of these hyperlinks does not constitute an endorsement or an approval by Vishay of any of the products, services or opinions of the corporation, organization or individual associated with the third-party website. Vishay disclaims any and all liability and bears no responsibility for the accuracy, legality or content of the third-party website or for that of subsequent links.

Except as expressly indicated in writing, Vishay products are not designed for use in medical, life-saving, or life-sustaining applications or for any other application in which the failure of the Vishay product could result in personal injury or death. Customers using or selling Vishay products not expressly indicated for use in such applications do so at their own risk. Please contact authorized Vishay personnel to obtain written terms and conditions regarding products designed for such applications.

No license, express or implied, by estoppel or otherwise, to any intellectual property rights is granted by this document or by any conduct of Vishay. Product names and markings noted herein may be trademarks of their respective owners.