

## Three Phase AC Switch (Power Modules), 100 A



MTK

**RoHS**  
COMPLIANT

### FEATURES

- Package fully compatible with the industry standard INT-A-PAK power modules series
- High thermal conductivity package, electrically insulated case
- Outstanding number of power encapsulated components
- Excellent power volume ratio
- 4000  $V_{RMS}$  isolating voltage
- UL E78996 approved
- Designed and qualified for industrial level
- Material categorization: for definitions of compliance please see [www.vishay.com/doc?99912](http://www.vishay.com/doc?99912)

### DESCRIPTION

A range of extremely compact, encapsulated three phase AC switches offering efficient and reliable operation. They are intended for use in general purpose and heavy duty applications as control motor starter.

PRIMARY CHARACTERISTICS	
$I_o$	100 A
$V_{RRM}$	800 V to 1600 V
Package	MTK
Circuit configuration	Three phase AC switch

MAJOR RATINGS AND CHARACTERISTICS			
SYMBOL	CHARACTERISTICS	VALUES	UNITS
$I_o$		100	A
	$T_C$	80	°C
$I_{FSM}$	50 Hz	1130	A
	60 Hz	1180	
$I^2t$	50 Hz	6380	A <sup>2</sup> s
	60 Hz	5830	
$I^2\sqrt{t}$		63 800	A <sup>2</sup> √s
$V_{RRM}$	Range	800 to 1600	V
$T_{Stg}$	Range	-40 to +125	°C
$T_J$	Range	-40 to +125	

### ELECTRICAL SPECIFICATIONS

VOLTAGE RATINGS					
TYPE NUMBER	VOLTAGE CODE	$V_{RRM}$ , MAXIMUM REPETITIVE PEAK REVERSE VOLTAGE V	$V_{RSM}$ , MAXIMUM NON-REPETITIVE PEAK REVERSE VOLTAGE V	$V_{DRM}$ , MAXIMUM REPETITIVE PEAK OFF-STATE VOLTAGE, GATE OPEN CIRCUIT V	$I_{RRM}/I_{DRM}$ , MAXIMUM AT $T_J = 125$ °C mA
VS-104MT..K	80	800	900	800	40 <sup>(1)</sup>
	100	1000	1100	1000	
	120	1200	1300	1200	
	140	1400	1500	1400	
	160	1600	1700	1600	

#### Note

<sup>(1)</sup> For single AC switch



FORWARD CONDUCTION					
PARAMETER	SYMBOL	TEST CONDITIONS		VALUES	UNITS
Maximum I <sub>RMS</sub> output current at case temperature	I <sub>O</sub>	For all conduction angle		100	A
				80	°C
Maximum peak, one-cycle forward, non-repetitive on state surge current	I <sub>TSM</sub>	t = 10 ms	No voltage reapplied	1130	A
		t = 8.3 ms			
		t = 10 ms	100 % V <sub>RRM</sub> reapplied	950	
		t = 8.3 ms			
Maximum I <sup>2</sup> t for fusing	I <sup>2</sup> t	t = 10 ms	No voltage reapplied	6380	A <sup>2</sup> s
		t = 8.3 ms			
		t = 10 ms	100 % V <sub>RRM</sub> reapplied	4510	
		t = 8.3 ms			
Maximum I <sup>2</sup> √t for fusing	I <sup>2</sup> √t	t = 0.1 ms to 10 ms, no voltage reapplied		63 800	A <sup>2</sup> √s
Low level value of threshold voltage	V <sub>T(TO)1</sub>	(16.7 % × π × I <sub>T(AV)</sub> < I < π × I <sub>T(AV)</sub> ), T <sub>J</sub> maximum		0.99	V
High level value of threshold voltage	V <sub>T(TO)2</sub>	(I > π × I <sub>T(AV)</sub> ), T <sub>J</sub> maximum		1.15	
Low level value on-state slope resistance	r <sub>t1</sub>	16.7 % × π × I <sub>T(AV)</sub> < I < π × I <sub>T(AV)</sub> , T <sub>J</sub> maximum		3.90	mΩ
High level value on-state slope resistance	r <sub>t2</sub>	(I > π × I <sub>T(AV)</sub> ), T <sub>J</sub> maximum		3.48	
Maximum on-state voltage drop	V <sub>TM</sub>	I <sub>pk</sub> = 150 A, T <sub>J</sub> = 25 °C, t <sub>p</sub> = 400 μs single junction		1.53	V
Maximum non-repetitive rate of rise of turned on current	dI/dt	T <sub>J</sub> = 25 °C, from 0.67 V <sub>DRM</sub> , I <sub>TM</sub> = π × I <sub>T(AV)</sub> , I <sub>g</sub> = 500 mA, t <sub>r</sub> < 0.5 μs, t <sub>p</sub> > 6 μs		150	A/μs
Maximum holding current	I <sub>H</sub>	T <sub>J</sub> = 25 °C, anode supply = 6 V, resistive load, gate open circuit		200	mA
Maximum latching current	I <sub>L</sub>	T <sub>J</sub> = 25 °C, anode supply = 6 V, resistive load		400	

BLOCKING					
PARAMETER	SYMBOL	TEST CONDITIONS		VALUES	UNITS
RMS isolation voltage	V <sub>INS</sub>	T <sub>J</sub> = 25 °C all terminal shorted f = 50 Hz, t = 1 s		4000	V
Maximum critical rate of rise of off-state voltage	dV/dt (1)	T <sub>J</sub> = T <sub>J</sub> maximum, linear to 0.67 V <sub>DRM</sub> , gate open circuit		500	V/μs

**Note**

(1) Available with dV/dt = 1000 V/μs, to complete code add S90 i. e. 104MT160KBS90

TRIGGERING					
PARAMETER	SYMBOL	TEST CONDITIONS		VALUES	UNITS
Maximum peak gate power	P <sub>GM</sub>	T <sub>J</sub> = T <sub>J</sub> maximum		10	W
Maximum average gate power	P <sub>G(AV)</sub>			2.5	
Maximum peak gate current	I <sub>GM</sub>			2.5	A
Maximum peak negative gate voltage	-V <sub>GT</sub>			10	V
Maximum required DC gate voltage to trigger	V <sub>GT</sub>	T <sub>J</sub> = 40 °C	Anode supply = 6 V, resistive load	4.0	V
		T <sub>J</sub> = 25 °C		2.5	
		T <sub>J</sub> = 125 °C		1.7	
Maximum required DC gate current to trigger	I <sub>GT</sub>	T <sub>J</sub> = -40 °C		270	mA
		T <sub>J</sub> = 25 °C		150	
		T <sub>J</sub> = 125 °C		80	
Maximum gate voltage that will not trigger	V <sub>GD</sub>	T <sub>J</sub> = T <sub>J</sub> maximum, rated V <sub>DRM</sub> applied		0.25	V
Maximum gate current that will not trigger	I <sub>GD</sub>			6	mA

THERMAL AND MECHANICAL SPECIFICATIONS				
PARAMETER	SYMBOL	TEST CONDITIONS	VALUES	UNITS
Maximum junction operating and storage temperature range	$T_J, T_{Stg}$		-40 to +125	°C
Maximum thermal resistance, junction to case	$R_{thJC}$	DC operation per single AC switch	0.34	K/W
		DC operation per junction	0.69	
		180 °C sine conduction angle per single AC switch	0.36	
		180 °C sine conduction angle per junction	0.72	
Maximum thermal resistance, case to heat sink	$R_{thCS}$	Per module Mounting surface smooth, flat and greased	0.03	
Mounting torque $\pm 100\%$	to heat sink to terminal	A mounting compound is recommended and the torque should be rechecked after a period of 3 hours to allow for the spread of the compound. Lubricated threads.	4 to 6	Nm
			3 to 4	
Approximate weight			225	g

$\Delta R$ CONDUCTION PER JUNCTION											
DEVICES	SINUSOIDAL CONDUCTION AT $T_J$ MAXIMUM					RECTANGULAR CONDUCTION AT $T_J$ MAXIMUM					UNITS
	180°	120°	90°	60°	30°	180°	120°	90°	60°	30°	
104MT.K	0.027	0.033	0.042	0.057	0.081	0.023	0.037	0.046	0.059	0.082	K/W

**Note**

- Table shows the increment of thermal resistance  $R_{thJC}$  when devices operate at different conduction angles than DC

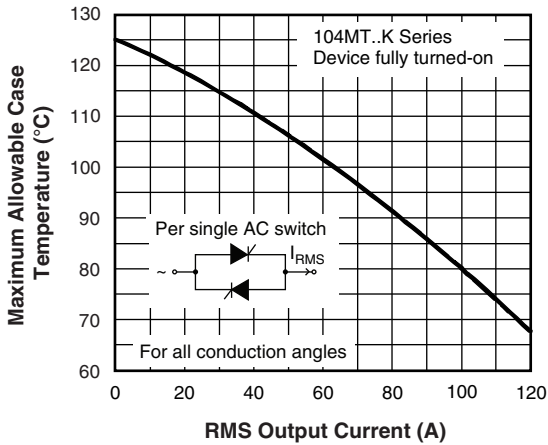

Fig. 1 - Current Ratings Characteristic

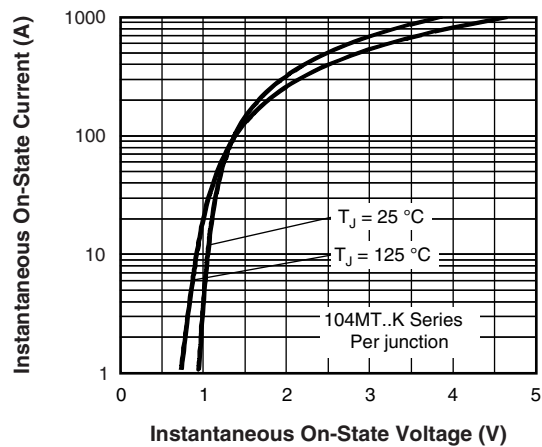

Fig. 2 - Forward Voltage Drop Characteristics

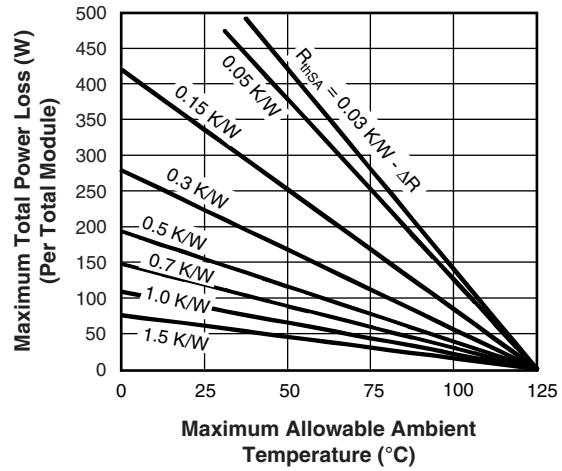
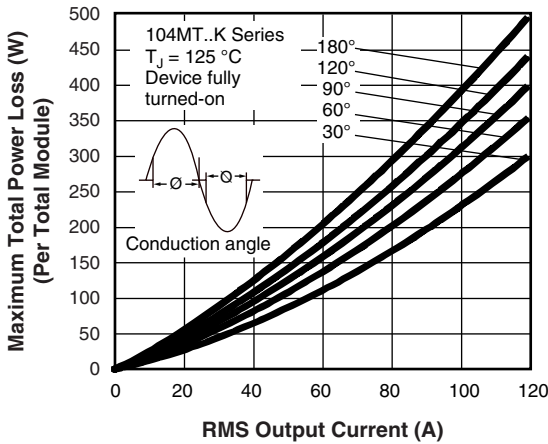

Fig. 3 - Total Power Loss Characteristics

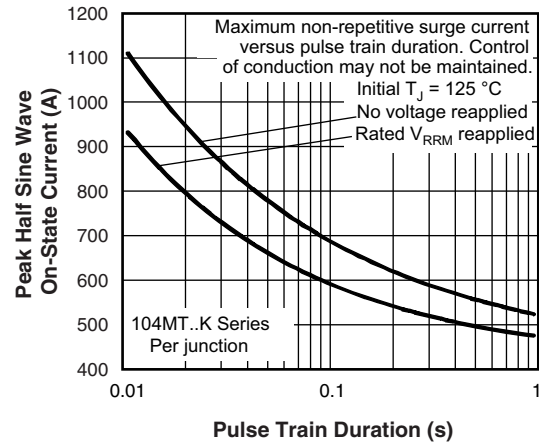
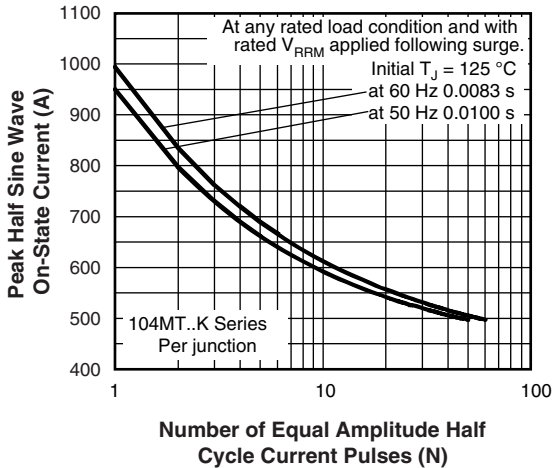

Fig. 4 - Maximum Non-Repetitive Surge Current

Fig. 5 - Maximum Non-Repetitive Surge Current

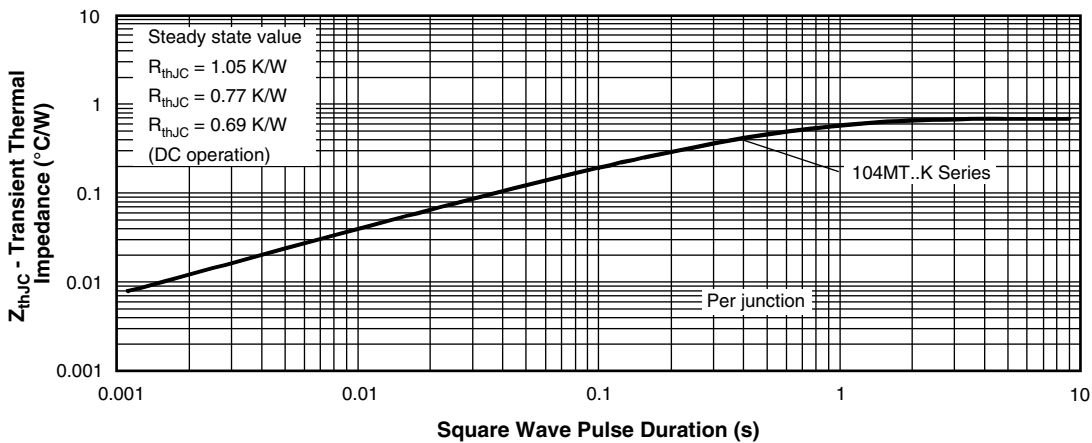

Fig. 6 - Thermal Impedance  $Z_{thJC}$  Characteristics

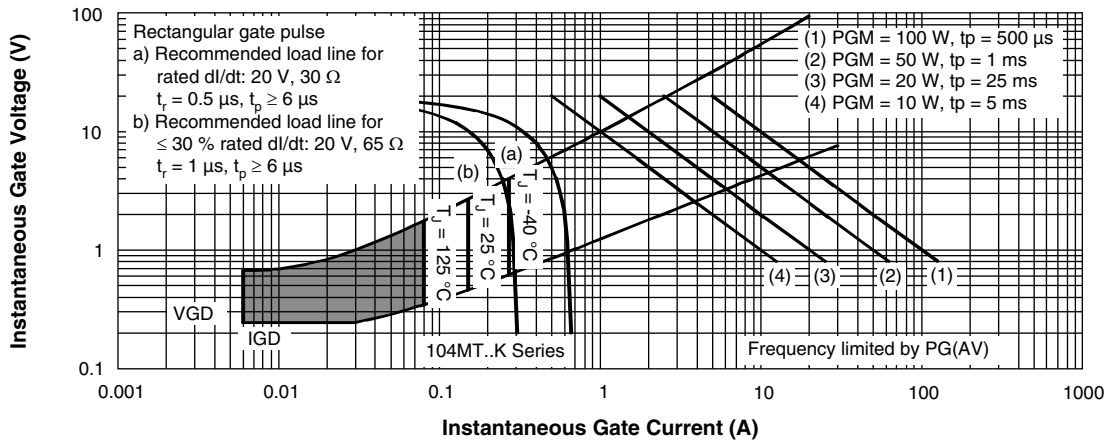

Fig. 7 - Gate Characteristics

**ORDERING INFORMATION TABLE**

Device code	<b>VS-</b>	<b>10</b>	<b>4</b>	<b>MT</b>	<b>160</b>	<b>K</b>	<b>PbF</b>
	(1)	(2)	(3)	(4)	(5)	(6)	(6)

- 1** - Vishay Semiconductors product
- 2** - Current rating code: 10 = 100 A (average)
- 3** - AC switch
- 4** - Essential part number
- 5** - Voltage code x 10 =  $V_{RRM}$  (see Voltage Ratings table)
- 6** - PbF = lead (Pb)-free

**Note**

- To order the optional hardware go to [www.vishay.com/doc?95172](http://www.vishay.com/doc?95172)

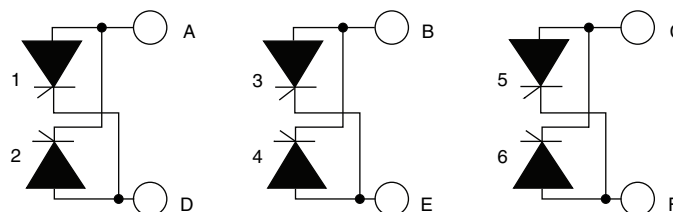
**CIRCUIT CONFIGURATION**

**LINKS TO RELATED DOCUMENTS**

Dimensions	<a href="http://www.vishay.com/doc?95004">www.vishay.com/doc?95004</a>
------------	--

## MTK (with and without optional barrier)

### DIMENSIONS WITH OPTIONAL BARRIERS in millimeters (inches)



# Outline Dimensions

Vishay Semiconductors MTK (with and without optional barrier)



## DIMENSIONS WITHOUT OPTIONAL BARRIERS in millimeters (inches)

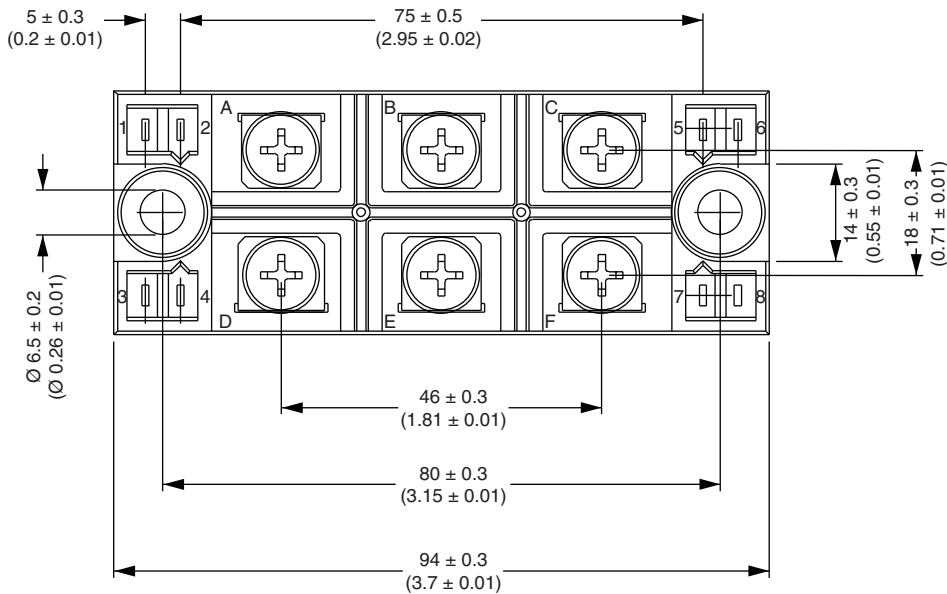
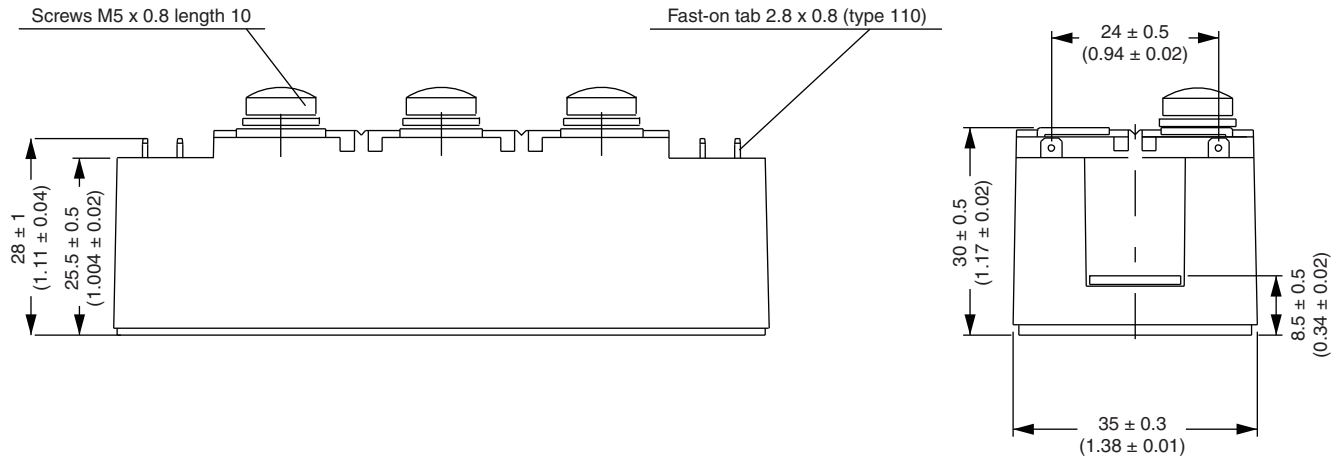



## Disclaimer

ALL PRODUCT, PRODUCT SPECIFICATIONS AND DATA ARE SUBJECT TO CHANGE WITHOUT NOTICE TO IMPROVE RELIABILITY, FUNCTION OR DESIGN OR OTHERWISE.

Vishay Intertechnology, Inc., its affiliates, agents, and employees, and all persons acting on its or their behalf (collectively, "Vishay"), disclaim any and all liability for any errors, inaccuracies or incompleteness contained in any datasheet or in any other disclosure relating to any product.

Vishay makes no warranty, representation or guarantee regarding the suitability of the products for any particular purpose or the continuing production of any product. To the maximum extent permitted by applicable law, Vishay disclaims (i) any and all liability arising out of the application or use of any product, (ii) any and all liability, including without limitation special, consequential or incidental damages, and (iii) any and all implied warranties, including warranties of fitness for particular purpose, non-infringement and merchantability.

Statements regarding the suitability of products for certain types of applications are based on Vishay's knowledge of typical requirements that are often placed on Vishay products in generic applications. Such statements are not binding statements about the suitability of products for a particular application. It is the customer's responsibility to validate that a particular product with the properties described in the product specification is suitable for use in a particular application. Parameters provided in datasheets and / or specifications may vary in different applications and performance may vary over time. All operating parameters, including typical parameters, must be validated for each customer application by the customer's technical experts. Product specifications do not expand or otherwise modify Vishay's terms and conditions of purchase, including but not limited to the warranty expressed therein.

Hyperlinks included in this datasheet may direct users to third-party websites. These links are provided as a convenience and for informational purposes only. Inclusion of these hyperlinks does not constitute an endorsement or an approval by Vishay of any of the products, services or opinions of the corporation, organization or individual associated with the third-party website. Vishay disclaims any and all liability and bears no responsibility for the accuracy, legality or content of the third-party website or for that of subsequent links.

Except as expressly indicated in writing, Vishay products are not designed for use in medical, life-saving, or life-sustaining applications or for any other application in which the failure of the Vishay product could result in personal injury or death. Customers using or selling Vishay products not expressly indicated for use in such applications do so at their own risk. Please contact authorized Vishay personnel to obtain written terms and conditions regarding products designed for such applications.

No license, express or implied, by estoppel or otherwise, to any intellectual property rights is granted by this document or by any conduct of Vishay. Product names and markings noted herein may be trademarks of their respective owners.