

650 V Power SiC Gen 3 Merged PIN Schottky Diode, 8 A

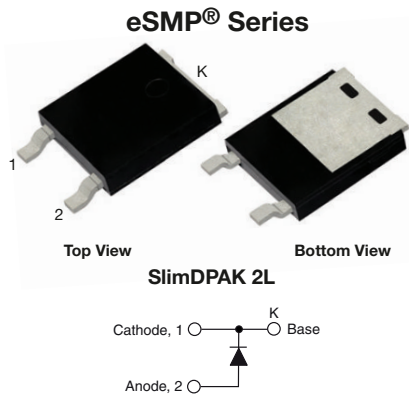

RoHS
COMPLIANT
HALOGEN
FREE

FEATURES

- Creepage and clearance distance 2.8 mm minimum
- Very low profile – typical height of 1.3 mm
- Majority carrier diode using Schottky technology on SiC wide band gap material
- Improved V_F and efficiency by thin wafer technology
- Positive V_F temperature coefficient for easy paralleling
- Virtually no recovery tail and no switching losses
- Temperature invariant switching behavior
- 175 °C maximum operating junction temperature
- MPS structure for high ruggedness to forward current surge events
- Meets JESD 201 class 2 whisker test
- Meet MSL level 1, per J-STD-020, LF maximum peak of 260 °C
- Material categorization: for definitions of compliance please see www.vishay.com/doc?99912

LINKS TO ADDITIONAL RESOURCES



DESCRIPTION / APPLICATIONS

Wide band gap SiC based 650 V Schottky diode, designed for high performance and ruggedness.

Optimum choice for high speed hard switching and efficient operation over a wide temperature range, it is also recommended for all applications suffering from Silicon ultrafast recovery behavior.

Typical applications include AC/DC PFC and DC/DC ultra high frequency output rectification in FBPS and LLC converters.

MECHANICAL DATA

Case: SlimDPAK 2L

Molding compound meets UL 94 V-0 flammability rating Base P/N-M3 - halogen-free, RoHS-compliant

Terminals: matte tin plated leads, solderable per J-STD-002 and JESD 22-B102

PRIMARY CHARACTERISTICS	
$I_{F(AV)}$	8 A
V_R	650 V
V_F at I_F at 25 °C, typ.	1.30 V
T_J max.	175 °C
I_R at V_R at 175 °C	25 μ A
Q_C ($V_R = 400$ V)	22 nC
Package	SlimDPAK 2L
Circuit configuration	Single

MAXIMUM RATINGS ($T_A = 25$ °C unless otherwise specified)				
PARAMETER	SYMBOL	NOTES / TEST CONDITIONS	VALUES	UNITS
Peak repetitive reverse voltage	V_{RRM}		650	V
Continuous forward current	I_F	$T_M = 151$ °C (DC)	8	A
DC blocking voltage	V_{DC}		650	V
Repetitive peak surge current	I_{FRM}	$T_M = 25$ °C, $f = 50$ Hz, square wave, DC = 25 %	42	A
Non-repetitive peak forward surge current	I_{FSM}	$T_M = 25$ °C, $t_p = 10$ ms, half sine wave	52	A
		$T_M = 110$ °C, $t_p = 10$ ms, half sine wave	51	
Power dissipation	$P_{tot}^{(1)}$	$T_M = 25$ °C	79	W
		$T_M = 110$ °C	34	
	$P_{tot}^{(2)}$	$T_M = 25$ °C	103	W
		$T_M = 110$ °C	45	
I^2t value	$\int i^2 dt$	$T_M = 25$ °C	13.5	A ² s
		$T_M = 110$ °C	12.5	
Operating junction and storage temperatures	$T_J^{(3)}, T_{Stg}$		-55 to +175	°C

Notes

(1) Based on maximum R_{th}

(2) Based on typical R_{th}

(3) The heat generated must be less than the thermal conductivity from junction-to-ambient: $dP_D/dT_J < 1/R_{\theta JA}$



ELECTRICAL SPECIFICATIONS (T _J = 25 °C unless otherwise specified)						
PARAMETER	SYMBOL	TEST CONDITIONS	MIN.	TYP.	MAX.	UNITS
Forward voltage	V _F	I _F = 8 A	-	1.3	1.5	V
		I _F = 8 A, T _J = 150 °C	-	1.50	1.80	
		I _F = 8 A, T _J = 175 °C	-	1.58	-	
Reverse leakage current	I _R	V _R = V _R rated	-	0.35	90	μA
		V _R = V _R rated, T _J = 150 °C	-	8	180	
		V _R = V _R rated, T _J = 175 °C	-	25	-	
Total capacitance	C	V _R = 1 V, f = 1 MHz	-	340	-	pF
		V _R = 400 V, f = 1 MHz	-	34	-	
Total capacitive charge	Q _C	V _R = 400 V, f = 1 MHz	-	22	-	nC

THERMAL - MECHANICAL SPECIFICATIONS (T _A = 25 °C unless otherwise specified)						
PARAMETER	SYMBOL	TEST CONDITIONS	MIN.	TYP.	MAX.	UNITS
Thermal resistance, junction-to-mount	R _{thJM}		-	1.45	1.90	°C/W
Marking device			3C08EV07T			

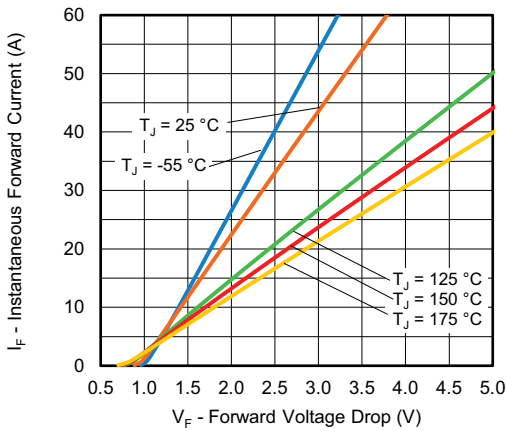

Fig. 1 - Typical Forward Voltage Drop Characteristics

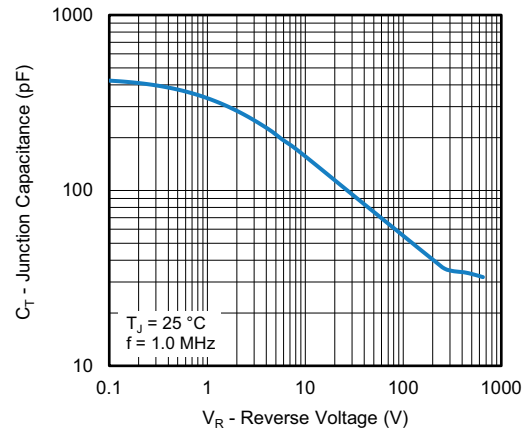

Fig. 3 - Typical Junction Capacitance vs. Reverse Voltage

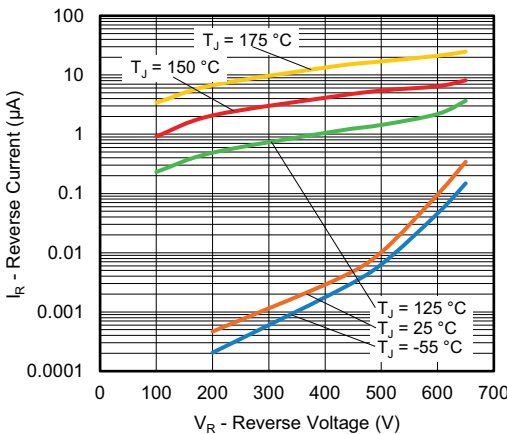

Fig. 2 - Typical Values of Reverse Current vs. Reverse Voltage

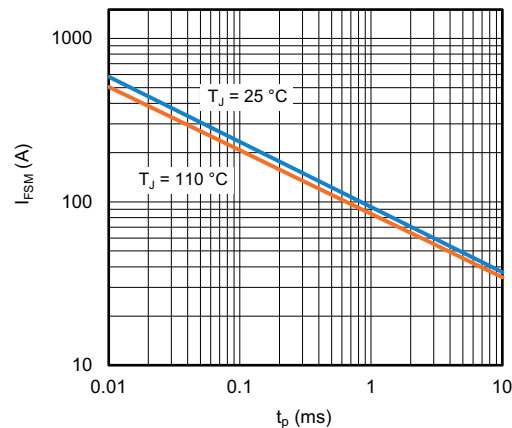

Fig. 4 - Non-Repetitive Peak Forward Surge Current vs. Pulse Duration (Square Wave)

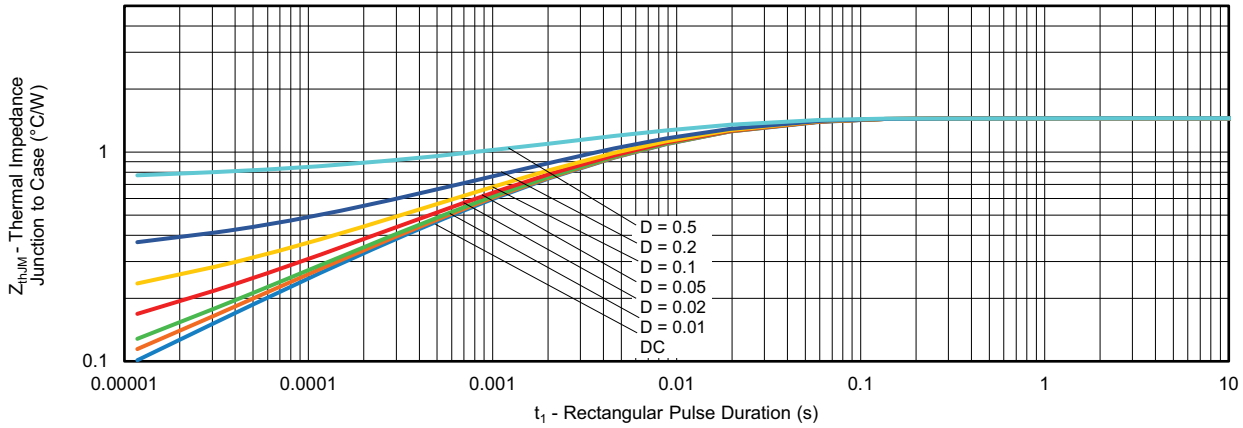

Fig. 5 - Typical Thermal Impedance Z_{thJM} Characteristics

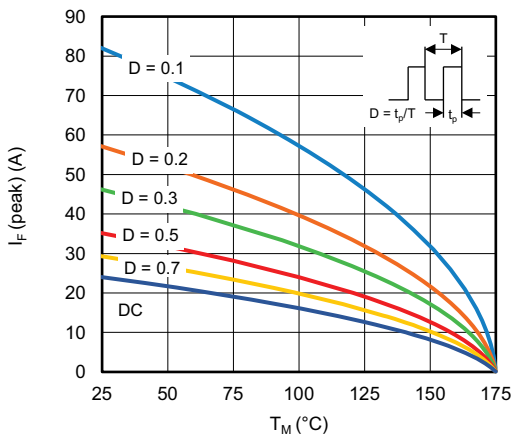

Fig. 6 - Peak Forward Current vs. Maximum Allowable Mount Temperature

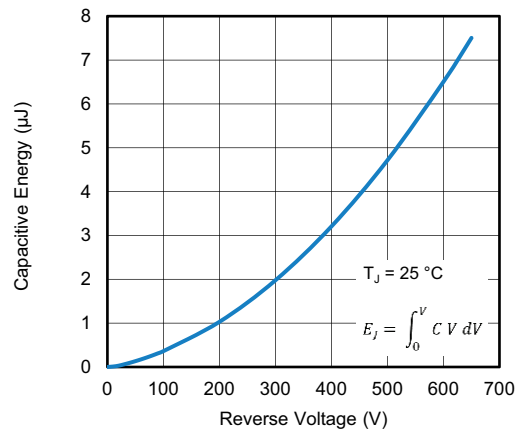

Fig. 8 - Typical Capacitive Energy vs. Reverse Voltage

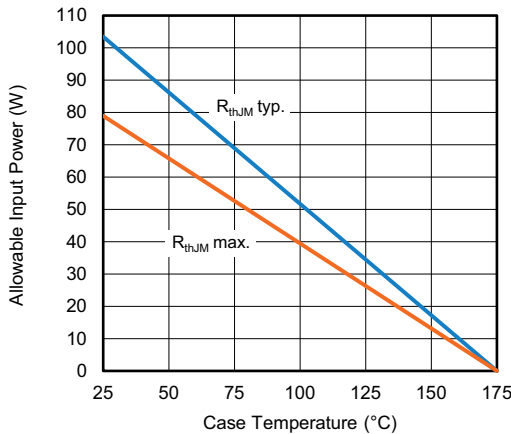

Fig. 7 - Forward Power Loss Characteristics

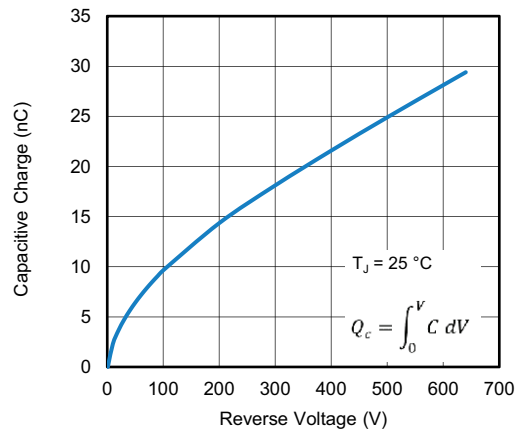
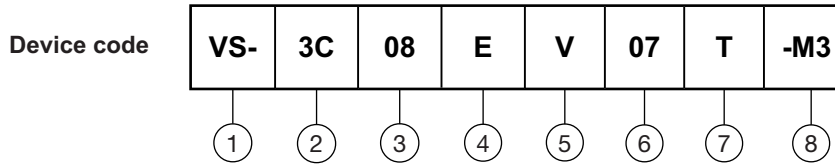

Fig. 9 - Typical Capacitive Charge vs. Reverse Voltage



ORDERING INFORMATION TABLE



- ① - Vishay Semiconductors product
- ② - 3C = SiC diode, Generation 3
- ③ - Current rating (08 = 8 A)
- ④ - E = single diode
- ⑤ - Package SlimDPAK
- ⑥ - Voltage rating: (07 = 650 V)
- ⑦ - T = true 2 pin
- ⑧ - Environmental digit:
-M3 = halogen-free, RoHS-compliant, and termination lead (Pb)-free

ORDERING INFORMATION (Example)				
ORDERING P/N	UNIT WEIGHT (g)	PACKAGE CODE	BASE QUANTITY	PACKAGING DESCRIPTION
VS-3C08EV07T-M3/I	0.20	I	4500	13" diameter plastic tape and reel

LINKS TO RELATED DOCUMENTS	
Dimensions	www.vishay.com/doc?97058
Part marking information	www.vishay.com/doc?97104
Packaging information	www.vishay.com/doc?88869



SlimDPAK 2L

DIMENSIONS in millimeters (inches)

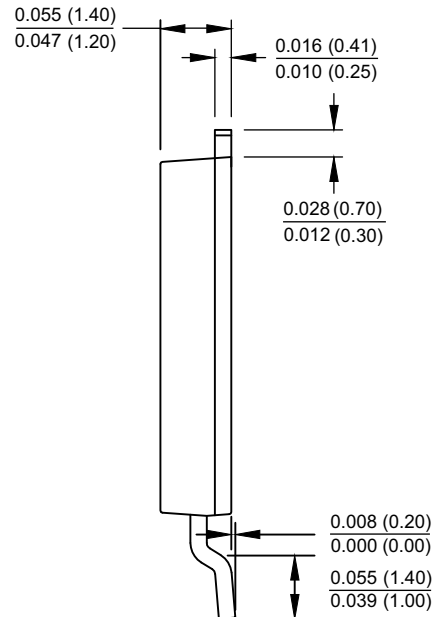
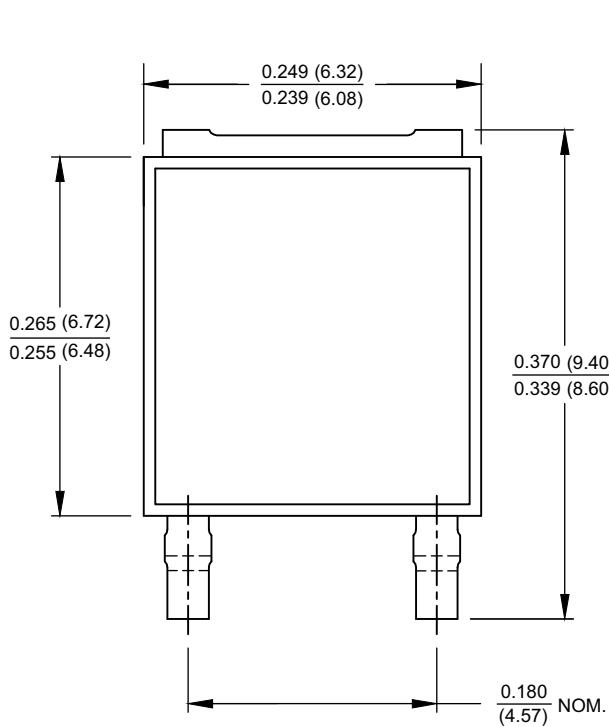

Mounting Pad Layout

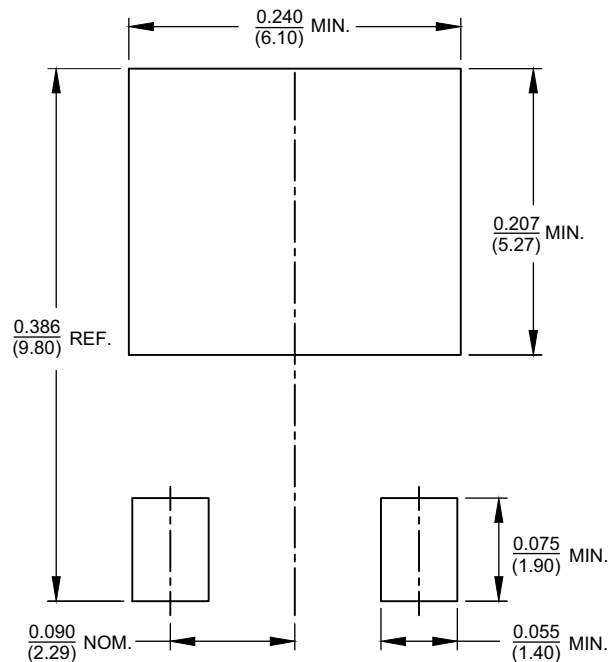
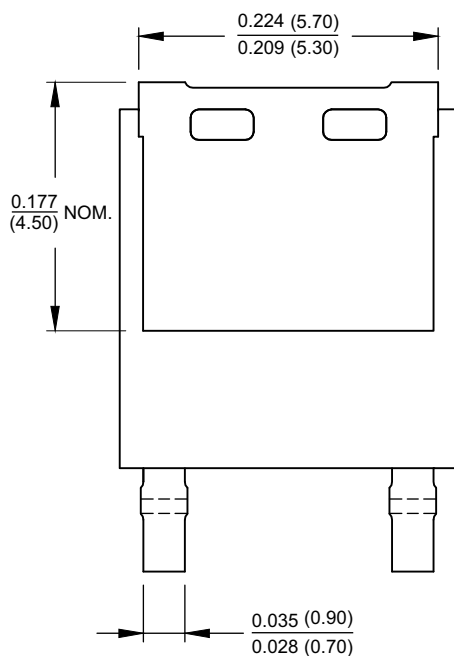



Disclaimer

ALL PRODUCT, PRODUCT SPECIFICATIONS AND DATA ARE SUBJECT TO CHANGE WITHOUT NOTICE TO IMPROVE RELIABILITY, FUNCTION OR DESIGN OR OTHERWISE.

Vishay Intertechnology, Inc., its affiliates, agents, and employees, and all persons acting on its or their behalf (collectively, "Vishay"), disclaim any and all liability for any errors, inaccuracies or incompleteness contained in any datasheet or in any other disclosure relating to any product.

Vishay makes no warranty, representation or guarantee regarding the suitability of the products for any particular purpose or the continuing production of any product. To the maximum extent permitted by applicable law, Vishay disclaims (i) any and all liability arising out of the application or use of any product, (ii) any and all liability, including without limitation special, consequential or incidental damages, and (iii) any and all implied warranties, including warranties of fitness for particular purpose, non-infringement and merchantability.

Statements regarding the suitability of products for certain types of applications are based on Vishay's knowledge of typical requirements that are often placed on Vishay products in generic applications. Such statements are not binding statements about the suitability of products for a particular application. It is the customer's responsibility to validate that a particular product with the properties described in the product specification is suitable for use in a particular application. Parameters provided in datasheets and / or specifications may vary in different applications and performance may vary over time. All operating parameters, including typical parameters, must be validated for each customer application by the customer's technical experts. Product specifications do not expand or otherwise modify Vishay's terms and conditions of purchase, including but not limited to the warranty expressed therein.

Hyperlinks included in this datasheet may direct users to third-party websites. These links are provided as a convenience and for informational purposes only. Inclusion of these hyperlinks does not constitute an endorsement or an approval by Vishay of any of the products, services or opinions of the corporation, organization or individual associated with the third-party website. Vishay disclaims any and all liability and bears no responsibility for the accuracy, legality or content of the third-party website or for that of subsequent links.

Except as expressly indicated in writing, Vishay products are not designed for use in medical, life-saving, or life-sustaining applications or for any other application in which the failure of the Vishay product could result in personal injury or death. Customers using or selling Vishay products not expressly indicated for use in such applications do so at their own risk. Please contact authorized Vishay personnel to obtain written terms and conditions regarding products designed for such applications.

No license, express or implied, by estoppel or otherwise, to any intellectual property rights is granted by this document or by any conduct of Vishay. Product names and markings noted herein may be trademarks of their respective owners.