



# XClampR™ TVS Application Note

By Sweetman Kim

## INTRODUCTION

Vishay's XClampR™ series of transient voltage suppressor (TVS) diodes with avalanche and snapback characteristics features an extremely low clamping ratio between the breakdown voltage and maximum clamping voltage. This low clamping ratio provides a lower clamping voltage at a higher peak pulse current than conventional TVS, allowing designers to use capacitors with lower working voltages, in addition to switching devices including polarity protection diodes, load switch MOSFETs, and regulator ICs

Additionally, XClampR TVS have a very stable breakdown voltage at a wide operating range of - 55 °C through + 175 °C. Stable operating characteristic of XClampR TVS makes the circuit meet automotive and industrial standard test and tough operating conditions.

This article explaining XClampR TVS, describes its advantages as compared to conventional TVS and overview of typical applications.

Vishay released 3 XClampR TVS of 24 V withstand voltage type of high power TVS.

**TABLE 1-1: SIMPLE TABLE OF XMC7K24CA, XLD5A24CA, AND XLD8A24CA SPECIFICATION**

PARAMETER	SYMBOL	PART NUMBER		
		XMC7K24CA	XLD5A24CA	XLD8A24CA
Maximum working stand-off voltage	$V_{WM}$	24 V		
Breakdown voltage	$V_{BR}$	26.7 V to 29.5 V		
Maximum clamping voltage	$V_{CL \text{ max.}}$	24 V	26 V	26 V
Maximum peak pulse power	$P_{PPM} (10 \mu\text{s}/1000 \mu\text{s})$	7000 W <sup>(1)</sup>	7700 W <sup>(1)</sup>	11 000 W <sup>(1)</sup>
	$P_{PPM} (10 \mu\text{s}/10\ 000 \mu\text{s})$	1200 W <sup>(1)</sup>	4600 W <sup>(1)</sup>	7000 W <sup>(1)</sup>
Maximum peak pulse current	$I_{PPM} (10 \mu\text{s}/1000 \mu\text{s})$	180 A	200 A	300 A
	$I_{PPM} (10 \mu\text{s}/10\ 000 \mu\text{s})$	30 A	120 A	180 A
Package	Package	SMC (DO-214AB)	DO-218AB	

### Note

<sup>(1)</sup> Equivalent  $P_{PPM}$  with conventional TVS

## XClampR™ TVS EXPLANATION

### 1. Characteristics of XClampR TVS

- 1-1. Unique snapback characteristics of XClampR TVS
- 1-2. Extremely low clamping voltage ratio in wide current range
- 1-3. High transient current clamping capability
- 1-4. Extremely stable characteristics in wide temperature range
- 1-5. Basic over-voltage protections and XClampR TVS
- 1-6. Clamping voltage range extending of XClampR™ TVS with conventional TVS

### 1. Example applications

- 1-1. Automotive load dump protection
- 1-2. DC-Link capacitor protection of 48 V powertrain
- 1-3. Drive circuit protection for robot arms and industrial purpose

The DNA of tech.™

# XClampR™ TVS Application Note

## 1. CHARACTERISTICS OF XClampR™ TVS

### 1-1. Unique Snapback characteristics of XClampR TVS

The snapback characteristics of the XClampR TVS make differences to a conventional TVS at breakdown and clamping operation.

I-V curve of conventional bidirectional TVS and XClampR TVS is as Fig.1-1.

Snapback operation of XClampR is initiated (triggered) by a small reverse leakage current at a certain voltage and avalanche operating at a sufficiently large voltage applied across the cathode and anode.

Clamping voltage is lower than the initial breakdown voltage and it can make a higher max. peak pulse current capability than a conventional TVS.

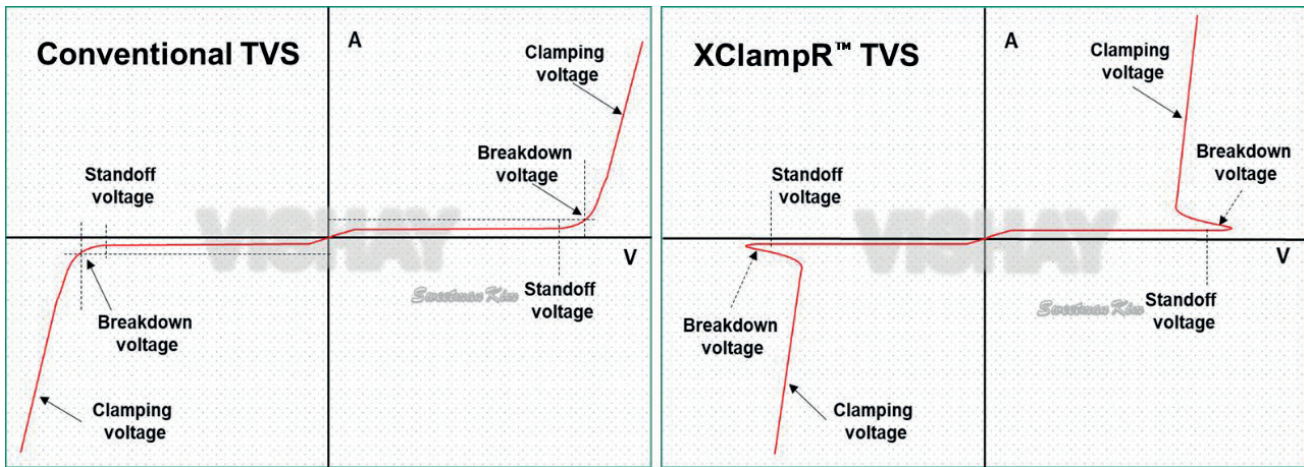
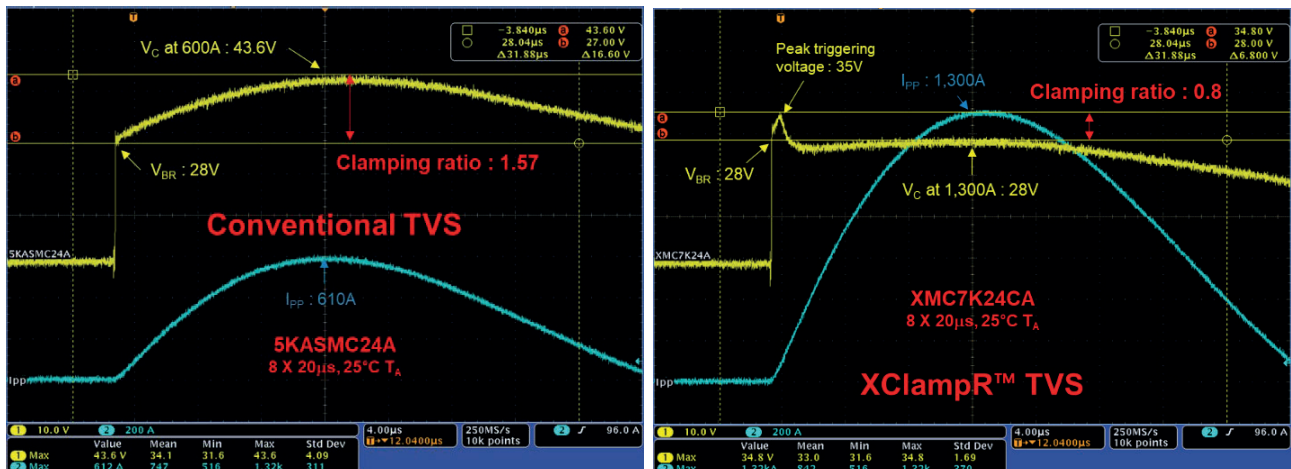

Fig.1-1: I-V Curve of Conventional Bidirectional TVS and XClampR™ TVS



This unique snapback clamping characteristic of XClampR TVS make low clamping voltage at high current than breakdown voltage as triggering at peak pulse current.

### XClampR™ TVS Application Note

**1-2. Is schematic circuit of XClampR™ TVS to explain the operation only, not real structure**

XClampR TVS have bidirectional transient voltage suppressing due to this structure.

Zener diodes in schematic circuit have higher  $V_{BR}$  than clamping voltage of TVS.

High positive transient voltage engaged in line to XClampR TVS,  $ZD_1$  will start breakdown and turn on TRIAC as triggering and  $TVS_1$  start to clamp input transient voltage and most energy is dissipated as Fig.1-3.

At negative transient voltage engaged in line to XClampR TVS,  $ZD_2$  will start breakdown and turn on TRIAC as triggering and  $TVS_2$  start to clamp input transient voltage.

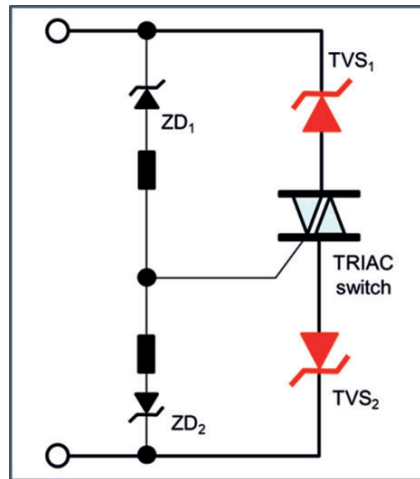

Fig.1-2: Schematic Circuit of XClampR™ TVS

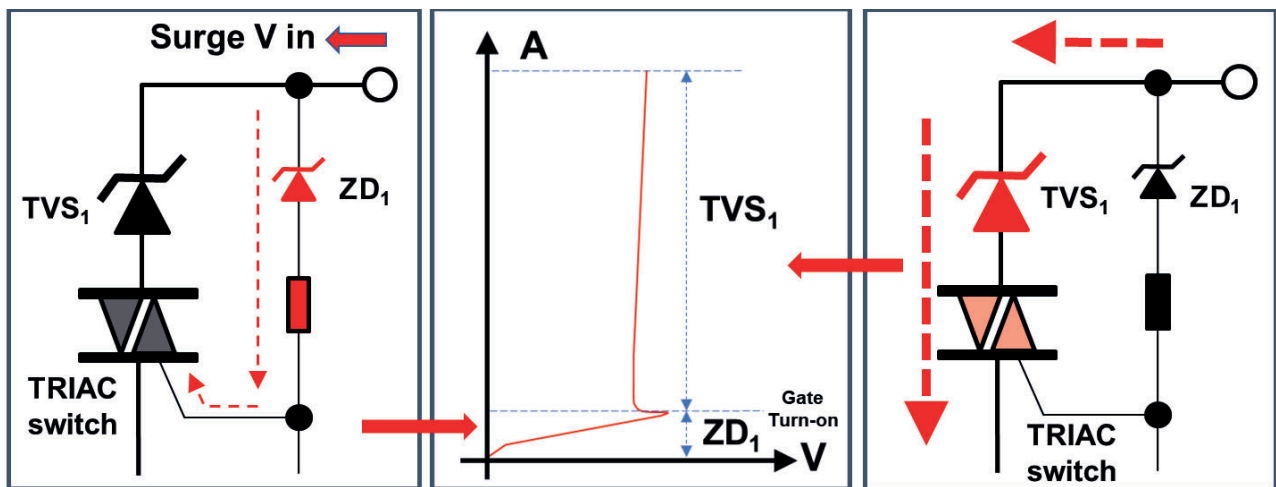

Fig.1-3: Operation Concept of XClampR™ TVS



The DNA of tech.™

## XClampR™ TVS Application Note

### 1-2. EXTREMELY LOW CLAMPING VOLTAGE IN WIDE CURRENT RANGES

The clamping voltage of the XClampR TVS is very low than conventional TVS.

Comparison of the clamping voltage between XMC7K24CA and 5KASMC24A type conventional TVS at different pulse wave form and device types.

The XMC7K24CA is the first released product of the XClampR TVS series with an SMC package that has a 26 V clamping voltage at 180 A, 1 ms half  $I_{PP}$  ( $I_{PP}/2$ ) pulse wave form in specification and 26 V clamping voltage at 584 A of 8  $\mu$ s by 20  $\mu$ s pulse wave.

5KASMC24A is the most similar type of conventional TVS to the XMC7K24CA, having a 38.9 V clamping voltage at 1 ms half  $I_{PP}$  ( $I_{PP}/2$ ) pulse wave form in specification and 44 V clamping voltage at 584 A of 8  $\mu$ s by 20  $\mu$ s pulse wave form.

By this low clamping voltage, the XClampR TVS can handle a higher max. peak pulse current than a conventional TVS in the same package; the XMC7K24CA can absorb 1200 A of 8  $\mu$ s by 20  $\mu$ s pulse wave form. This max. peak pulse current capability is almost two times the maximum max. peak pulse current of the 5KASMC24A conventional TVS.

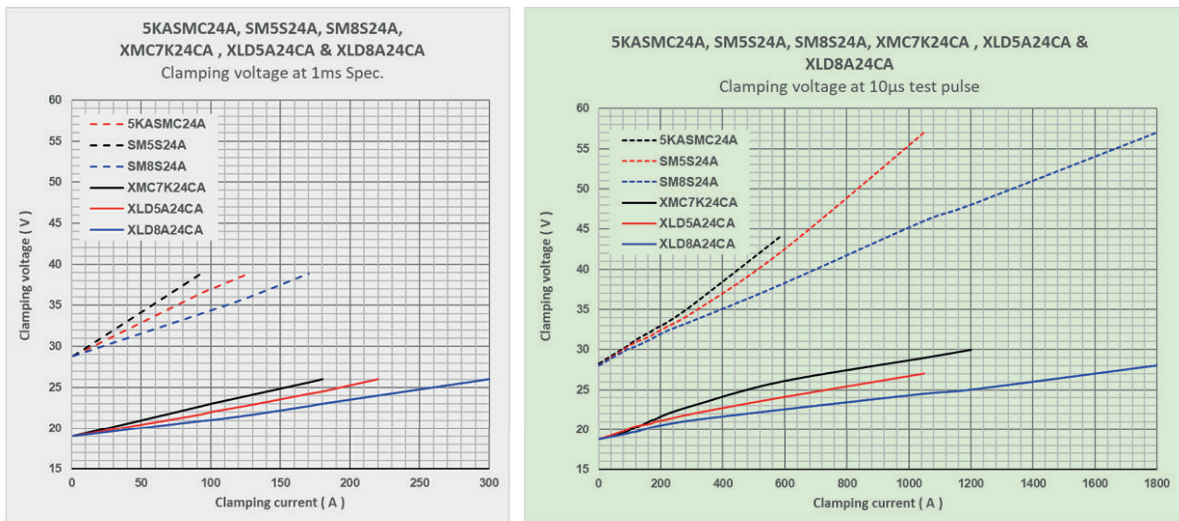

Fig. 1-5: Clamping Voltages of XClampR™ TVS and Conventional TVS



### XClampR™ TVS Application Note

#### 1-3. HIGH TRANSIENT PEAK PULSE CURRENT CAPABILITY

Basic function of TVS is clamping transient voltages and current flow thru TVS at clamping voltage.

Current flow through TVS at clamping voltage of TVS in transient voltage is calculated by following equation as:

$$I_{PP} = (U_S - V_C) / R_i$$

$I_{PP}$ : Max. peak pulse current at clamping voltage

$U_S$ : Surge and transient voltage

$V_{CL}$ : Clamping voltage

$R_i$ : Line impedance

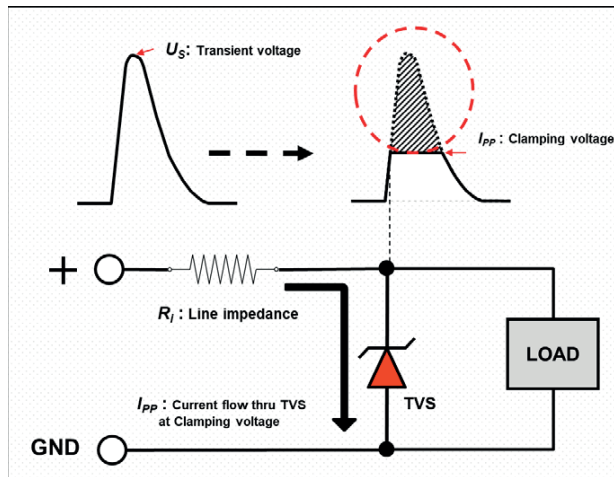

Fig. 1-6: Clamping Operation of TVS

Max. peak pulse current capability of XClampR™ TVS at various pulse width is as Table 1-2 and Fig.1-7. XClampR™ TVS have high current capability than same package type of conventional TVS due to low clamping voltage.

TABLE 1-2: MAX. PEAK PULSE CURRENT OF XClampR™ TVS AND CONVENTIONAL TVS							
PART NUMBER	SPECIFICATION						
	$V_w$	TYP. $V_{BR}$	PEAK PULSE CURRENT CAPABILITY $I_{pp}/2$ , EXP. at 25 °C				
			$V_{CL}$ TYP.	10 $\mu$ s	1ms	10 ms	100 ms
	V	25 °C	V	A			
XMC7K24CA	24	28	24.0	1800	180	30	5
5KASMC24A	24	28	38.9	580	128	15	3
XLD5A24CA	24	28	26.0	1450	198	120	40
SM5S24A	24	28	38.9	1000	93	72	32
XLD8A24CA	24	28	24.0	2500	300	180	70
SM8S24A	24	28	38.9	1700	170	133	52

The high transient capabilities of XClampR TVS meet most automotive and industrial requirements and testing conditions, including ISO 7637-2, ISO 16750-2, IEC 61000-4-2 (ESD), IEC 61000-4-5, and more. For IEC 61000-4-5, the XLD8A24CA meets Class 1 to 4 requirements (4 kV, 2 kA at an 8/20 ms condition), while the XLD5A24CA / XMC7K24CA meet Class 1 to 3 requirements (2 kV, 1 kA at an 8/20 ms condition).

### XClampR™ TVS Application Note

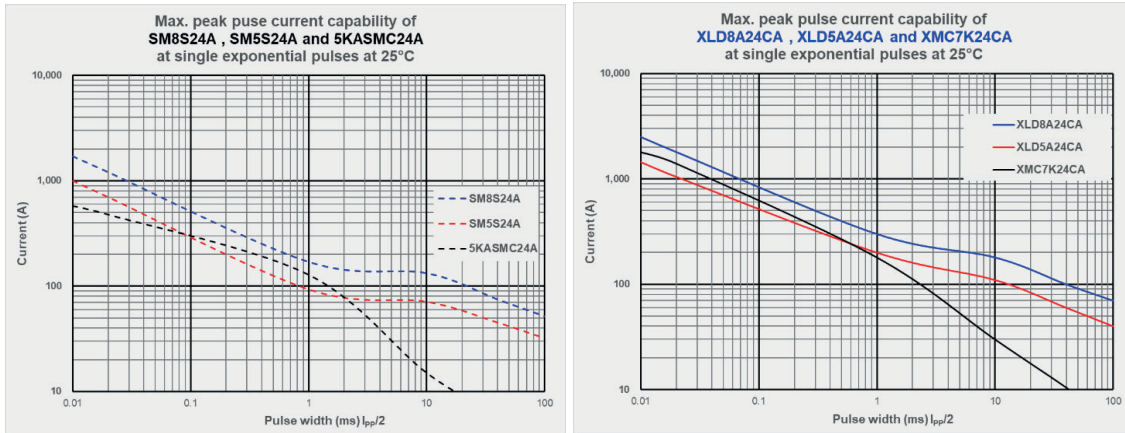

Fig. 1-7: Maximum Peak Pulse Current of XClampR® TVS

The XMC7K24CA and 5KASMC24A offer 7 kW and 5 kW at 1ms, respectively, which are higher power capabilities than the SM5S24A and XLD5A24CA at that pulse width. But as shown in the above graphs, their power capabilities are reduced in long pulse widths over 1 ms due to the high transient thermal impedance created by their limited package dimensions.

#### 1-4. EXTREMELY STABLE BREAKDOWN VOLTAGE ( $V_{BR}$ ) AND CLAMPING VOLTAGE ( $V_C$ ) OVER A WIDE OPERATING TEMPERATURE RANGE

An additional strength of XClampR TVS is stable breakdown and clamping voltages over a wide operating temperature range. The XMC7K24CA and XLD8A24CA have only a 1.2 V difference in breakdown voltage from junction temperatures of -40 °C to +150 °C. This difference is much smaller than that of conventional TVS, such as the 4.5 V and 4.6 V difference of the 5KASMC24A, SM5S24A, and SM8S24A.

TABLE 1-3: BREAKDOWN VOLTAGES OF CONVENTIONAL TVS AND XClampR™ TVS							
PART NUMBER	$T_A = T_J$ (°C)						$V_{BR}$ DIFF. -40 °C TO 150 °C
	-40	25	85	125	150	175	
5KASMC24A	27.2	28.1	28.5	28.6	28.3	27.4	1.2
SM5S24A	27.0	27.9	28.5	28.9	29.0	27.8	1.9
SM8S24A	26.8	27.6	27.9	28.1	28.0	26.9	1.2
XMC7K24CA	26.5	28.1	29.6	30.5	31.1	31.7	4.6
XLD5A24CA	26.5	28.1	29.7	30.6	31.1	31.6	4.6
XLD8A24CA	26.2	27.7	29.2	30.1	30.6	31.1	4.5

## XClampR™ TVS Application Note

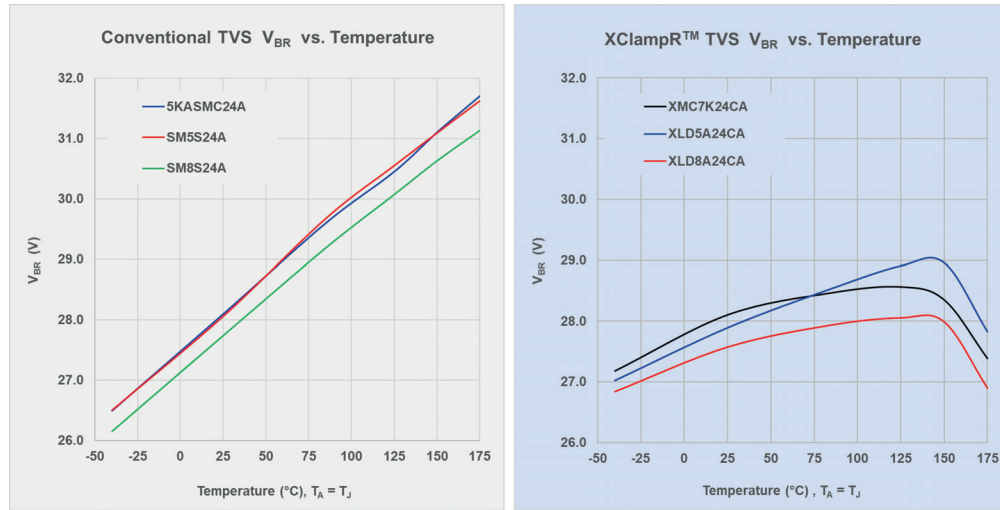

Fig. 1-8: Breakdown Voltages of Conventional TVS and XClampR TVS

XClampR TVS also have stable clamping voltages over wide current and temperature ranges (as shown in Table 1-4).

<b>TABLE 1-4: MAX. PEAK PULSE CURRENT OF XClampR™ TVS AND CONVENTIONAL TVS</b>									
PART NUMBER	SPECIFICATION								
	$V_W$ (V)	TYP. $V_{BR}$ AT 25 °C	PULSE WIDTH AND PEAK PULSE CURRENT $I_{PP}/2$ , EXP. 25 °C			MAX. $V_{TRIG.}$ (1) (V)	MAX. CLAMPING VOLTAGE (2) (V)		
			1ms	10 ms	100 ms		-40 °C	25 °C	125 °C
XLD8A24CA	24.0	28.1	300	180	70	33.0	22.0	24.0	25.0
SM8S24A	24.0	28.1	170	133	52	-	37.3	38.9	42.0
XLD5A24CA	24.0	28.1	200	120	40	33.0	24.0	26.0	27.0
SM5S24A	24.0	28.1	93	72	32	-	37.3	38.9	42.0
XMC7K24CA	24.0	28.1	180	30	5	33.0	22.0	24.0	25.0
5KASMC24A	24.0	28.1	128	15	3	-	37.3	38.9	42.0

**Notes**

- (1) Maximum triggering voltage at specified currents and 25 °C  $T_A$
- (2) Maximum clamping voltage at specified currents and  $T_A$

The clamped voltages of the XClampR TVS do not exceed 35 V at high temperatures, including the triggering voltage. This is much lower than the clamping voltage of conventional TVS, which is 42 V at same peak pulse current and 125 °C  $T_A$ . The extremely stable breakdown and clamping voltages of the XClampR TVS translate into stable operation for circuits with wide temperature ranges. They also avoid incorrect clamping operation, such as breakdown at low voltages in low temperature conditions or not clamping at high voltages in high temperature conditions.



## XClampR™ TVS Application Note

### 1-5. BASIC OVERVOLTAGE PROTECTION AND XClampR TVS

Commonly using three types of Transient voltage protection method as below

#### 1-5-1. Clamping protection

Clamping protection is one of typical transient suppressing circuit which used breakdown voltage of Zener diode, Avalanche breakdown diode or MOV (Metal oxide varistor), current drain thru protection device when transient voltages over breakdown or clamping voltage.

Clamping protection circuit meet to class A of ISO 16750-1 functional status classification

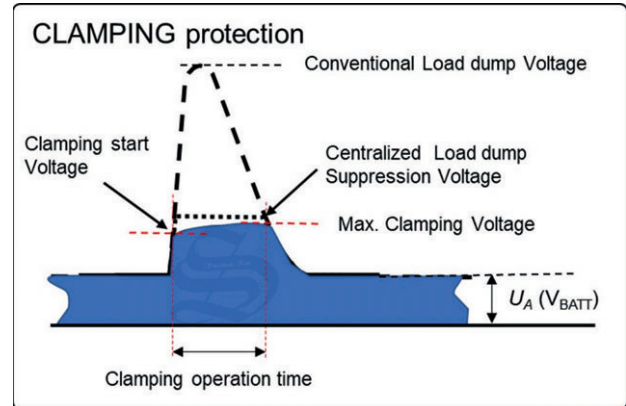

Fig. 1-9: Clamping Protection

#### 1-5-2. Crow-bar protection

Crow-bar protection is a fail-safe protection structure which electrical shorts circuit at overvoltage applied in line. Gas Discharge tube or Thyristor type TVS are used for this kind of applications.

Commonly use with fuse or PTC for over-current protection in operation and this protection method is meet to class C, D or E of ISO 16750-1 functional status classification due to the intermittent time or blowing of the power line fuse or tripping the circuit breaker.

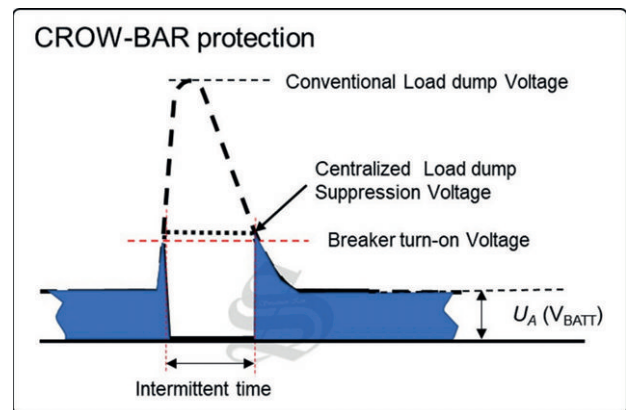

Fig. 1-10: Crow-bar Protection

#### 1-5-3. Snap-back protection

Snap-back protection has intermediate characteristics between clamping protection and Crow-bar protection to keep operating voltage without interrupt or trip-out and less power dissipation in operation.

XClampR™ TVS is designed for this kind of application and Vishay released 3 types of different clamping power capability of 1 working voltage for lot of applications.

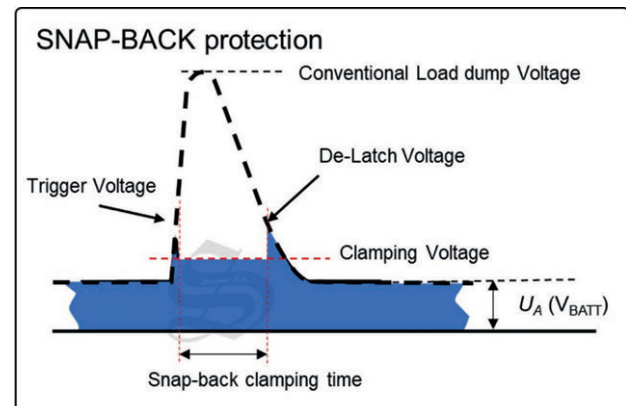

Fig. 1-11: Snap-back Protection

### XClampR™ TVS Application Note

#### 1-6. XClampR TVS ASYMMETRICAL AND SYMMETRICAL CLAMPING VOLTAGE EXTENSION WITH CONVENTIONAL TVS

Vishay only has XClampR TVS with low clamping voltages, but several unidirectional and bidirectional TVS series with various clamping voltages. These devices, when connected in series with XClampR TVS, can extend their asymmetrical and symmetrical clamping voltage ranges for various protection purposes, as pictured below.

The clamping voltage at a positive transient voltage is the sum of the clamping voltages of the XClampR TVS and conventional TVS. At a negative transient voltage, the clamping voltage equals the XClampR TVS' clamping voltage plus the forward voltage of the unidirectional TVS. Bidirectional TVS and XClampR TVS can make symmetrical clamping characteristics at positive and negative voltage transients, and the clamping voltage is the sum of XClampR TVS and conventional bidirectional TVS clamping voltages. The maximum peak pulse current capability of both combinations is limited by the smaller side of the device. Fig.1-9: Clamping Protection

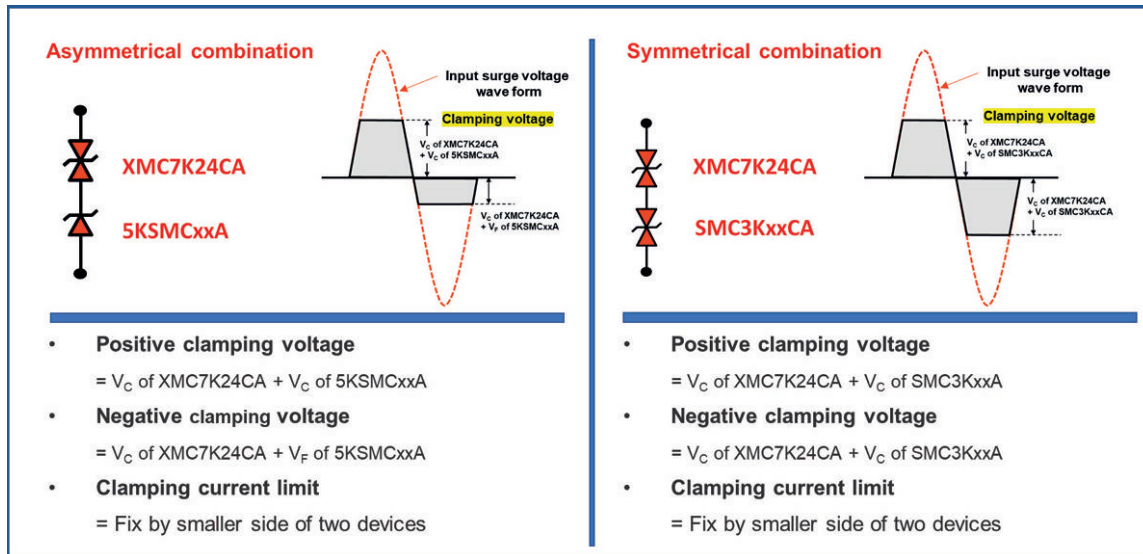

Fig.1-9: Asymmetrical and Symmetrical Combinations

This kind of combination can be utilized in automotive and industrial applications with variable voltage specifications, including + 48 V / - 33 V, + 58 V / - 33 V, or other requirements. Detailed information regarding these combinations is listed in Table 1-5 and Table 1-6. As shown in the tables, all combinations provide very low and stable clamping voltage compared to conventional TVS.



The DNA of tech.™

## XClampR™ TVS Application Note

**TABLE 1-5: CONVENTIONAL TVS AND XClampR TVS COMBINATION FOR ASYMMETRICAL CLAMPING VOLTAGES**

PART NUMBER	POSITIVE TRANSIENTS						NEGATIVE TRANSIENTS				
	V <sub>w</sub> (V)	V <sub>c</sub> (V)	TYP. V <sub>BR</sub> AT 25 °C (V)	PULSE WIDTH AND PEAK PULSE CURRENT I <sub>pp/2</sub> , EXP.			MAX. CLAMPING VOLTAGE (V)			PEAK PULSE CURRENT AT 8.3 ms (A)	CLAMPING VOLTAGE (V)
				1 ms	10 ms	100 ms	- 40 °C	25 °C	125 °C		
5KASMC36A	36	53.3	42.1	94	17	2	51	54	58	200	- 3
XMC7K24CA + 5KASMC12A	36	45.9	42.1	198	30	6	41	43	45	50	- 33
XLD8A24CA + SM8S12A	36	43.9	42.1	300	170	70	42	44	47	200	- 33
XMC7K24CA + 5KASMC24A	48	62.9	56.2	129	23	3	59	63	65	50	- 33
XLD8A24CA + SM8S24A	48	62.9	56.2	170	134	46	58	63	66	200	- 33
XMC7K24CA + 5KASMC33A	57	77.3	66.8	94	19	2	72	75	80	50	- 33
XLD5A24CA + SM5S33A	57	79.3	66.8	68	53	21	74	80	84	150	- 33
XLD8A24CA + SM8S33A	57	77.3	66.8	124	98	34	73	77	81	200	- 33

**TABLE 1-6: CONVENTIONAL TVS AND XClampR TVS COMBINATION FOR SYMMETRICAL CLAMPING VOLTAGES**

PART NUMBER	V <sub>w</sub> (V)	TYP. V <sub>BR</sub> AT 25 °C (V)	PULSE WIDTH AND PEAK PULSE CURRENT I <sub>pp/2</sub> , EXP. 25 °C			MAX. CLAMPING VOLTAGE (V)		
			1ms	10 ms	100 ms	-40 °C	25 °C	125 °C
SMC3K36CA	36	42.1	51.6	12.3	1.5	56	58	62
XMC7K24CA + SMC3K12CA	36	42.1	151.0	30.0	4.3	41	43	45
SMC3K48CA	48	56.1	38.8	9.5	1.1	74	77	83
XMC7K24CA + SMC3K24CA	48	56.2	77.1	18.0	2.2	59	63	66
SMC3K58CA	58	67.8	32.1	7.8	0.9	90	94	101
SMC3K28CA + SMC3K28CA	56	65.6	66.1	17.0	1.7	87	91	97
XMC7K24CA + SMC3K33CA	57	66.8	56.3	14.0	1.6	73	76	81

### XClampR™ TVS Application Note

#### 2. EXAMPLE APPLICATIONS

This chapter explores application examples for XClampR TVS. The devices' unique characteristics can be utilized in a wide range of application circuits beyond those discussed here.

##### 2-1. Automotive Load Dump Protection

XClampR TVS can be utilized in a variety of functions in automotive applications, including load dump protection, freewheeling and anti-parallel diodes, and more. Load dump transients have the highest power among transients that occur in vehicles, and can lead to the malfunction or failure of electronic systems. With low and stable clamping voltage, an XClampR TVS is the most suitable device for suppressing load dump transients.

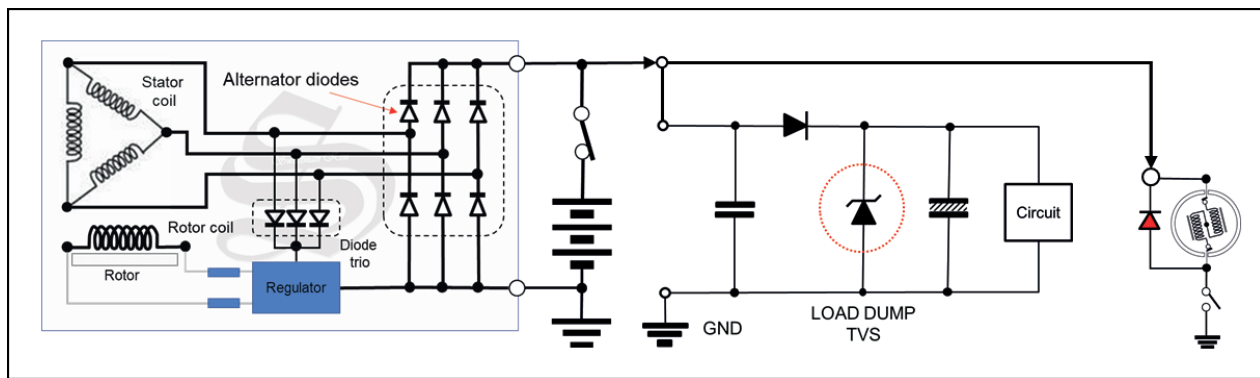

Fig.2-1: Diagram of Vehicle Powernet

There are many automotive standard regulations specified for the load dump condition. This application note is based on ISO 7637-2: 2011 and ISO 16750-2: 2012

##### 2-1-1. For 12 V Powertrains

The XLD5A24CA and XLD8A24CA can be used in most compact vehicles with 12 V powertrains as R<sub>i</sub> (Table 2-1).

TABLE 2-1: CLAMPING VOLTAGES OF XClampR TVS AND CONVENTIONAL TVS FOR THE 12 V ISO TEST									
PART NUMBER	STAND-OFF IN OPERATING TEMPERATURE RANGE T <sub>J</sub> (V)	ISO 7637-2: 2011				ISO 16750-2			
		PULSE 1	PULSE 2a	PULSE 3a	PULSE 3b	PULSE a		PULSE b	
		-150 V, 2 ms, 10 Ω	112 V, 50 μs, 2 Ω	220 V, 0.15 μs, 50 Ω	150 V, 0.15 ms, 50 Ω	101 V, 400 ms, 1 pulse	101 V, 400 ms, 10 pulses	101 V, 400 ms, 0.5 Ω	101 V, 400 ms, 1.0 Ω
		CLAMPING VOLTAGE (V)				MAX. R <sub>i</sub> (Ω)		U <sub>s</sub> (V)	
XMC7K24CA	24.0	-33.0	34.0	-30.0	37.0	n/a		n/a	
SM5S24A	24.0	-3.0	33.0	-3.0	35.0	1.50	2.25	34.0	36.5
SM6S24A	24.0	-3.0	32.0	-3.0	35.0	1.25	2.00	34.0	37.0
SM8S24A	24.0	-3.0	32.0	-3.0	34.0	0.75	1.30	35.0	37.5
XLD5A24A	24.0	-34.0	35.0	-34.0	35.0	1.50	2.00	2 Ω for all voltage range	
XLD8A24A	24.0	-33.0	34.0	-33.0	34.0	0.75	1.25	1.25 Ω for all voltage range	

## XClampR™ TVS Application Note

The graph in Fig.2-2 compares the size and  $R_i$  of a 12 V alternator using the formula in the ISO 16750-2: 2012 4.6.4.2 load dump testing method. The actual  $R_i$  will have a higher resistance value than in the graph, and detail information will be noted in the alternator specifications by the manufacturer.

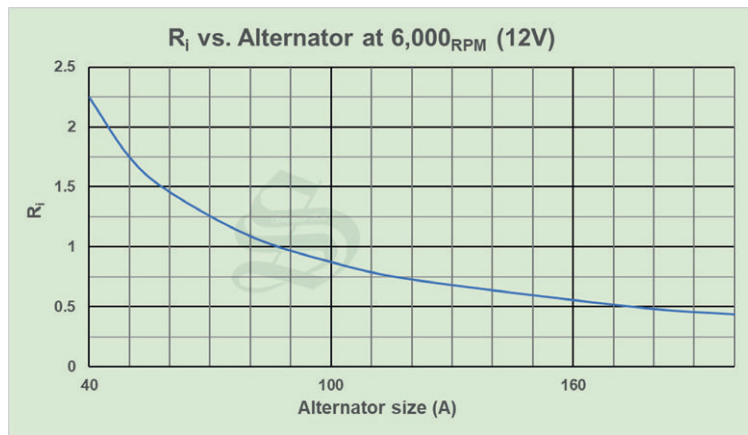

Fig.2-2: 12 V Alternator vs.  $R_i$

Fig.2-3 shows the clamping voltage versus the peak pulse current during the ISO 16750-2: 2012 load dump test. The XLD5A24CA and XLD8A24CA have low clamping voltages under 33 V, which is 7 V lower than the SM5S24A and SM8S24A conventional TVS.

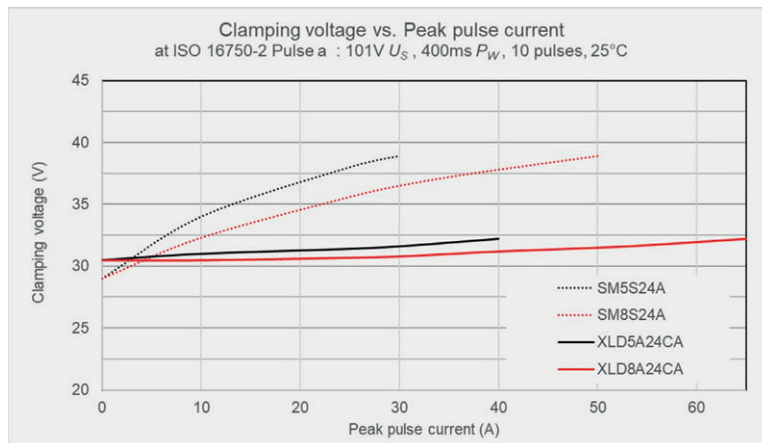

Fig.2-3: Clamping Voltage vs. Peak Pulse Current



The DNA of tech.™

## XClampR™ TVS Application Note

Fig.2-4 shows the waveforms of the SM8S24A and XLD8A24CA at a load dump test condition of 101 V US with a 400 ms pulse width, 1.25 W R<sub>i</sub>, and 10 pulses in 10 minutes

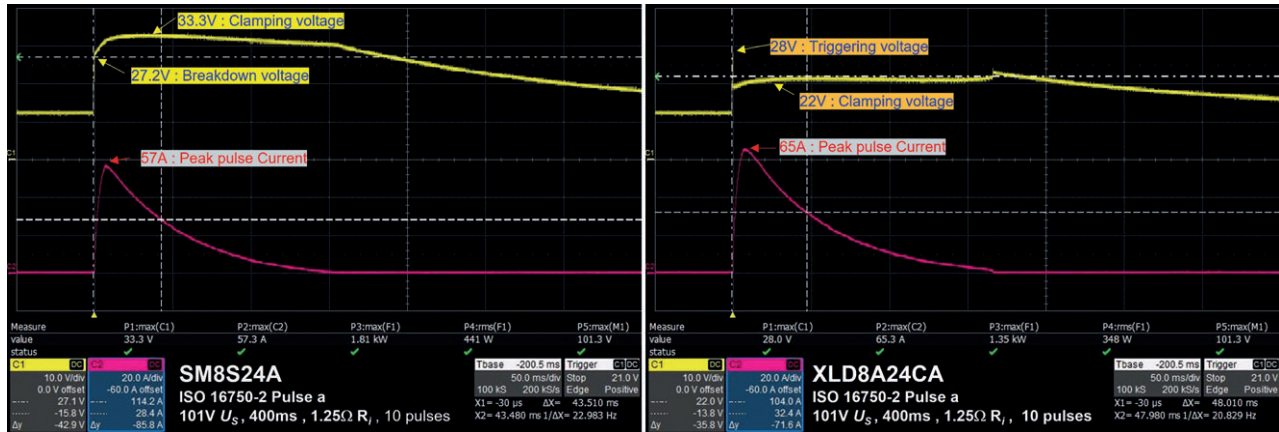

Fig.2-4: Waveforms of the SM8S24A and XLD8A24CA at Load Dump Test

The peak pulse current (I<sub>pp</sub>) can be obtained by using the equation transient voltage – clamping voltage / resistance.

Fig. 2-5 shows the maximum current capabilities of the XClampR TVS series at different pulse waveforms and widths.

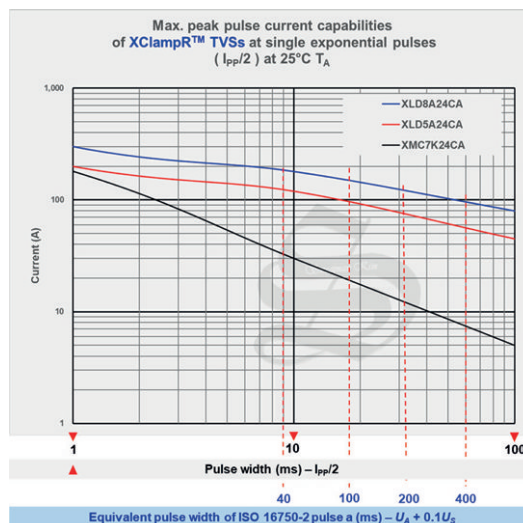

Fig.2-5: Maximum Current Capabilities of the XClampR TVS Series

Example:

Get the I<sub>pp</sub> of the XLD8A24CA at 101 V U<sub>S</sub>, 1 R<sub>i</sub> with a 200 ms pulse width, as specified in ISO 16750-2, and check to see if it meets the safe operating area (SOA). The I<sub>pp</sub> is 77 A (101 V U<sub>S</sub> – 24 V max. V<sub>C</sub> / 1 W R<sub>i</sub>) and the pulse width is near the 33 ms of the I<sub>pp</sub>/2 pulse width. This current is much lower than the permissible I<sub>pp</sub> of the XLD8A24CA, which is 120 A at 33 ms (Fig.2-5).

The DNA of tech.™

### XClampR™ TVS Application Note

#### 2-1-2. For 24 V Powertrains

XClampR TVS can also be used in 24 V powertrains, even with a single clamping voltage of 24 V

TABLE 2-2: CLAMPING VOLTAGES OF XClampR TVS AND CONVENTIONAL TVS FOR THE 24 V ISO TEST									
PART NUMBER	STAND-OFF VOLTAGE IN OPERATING TEMPERATURE RANGE $T_J$	ISO 7637-2				ISO 16750-2			
		PULSE 1	PULSE 2a	PULSE 3a	PULSE 3b	PULSE a		PULSE b	
		- 600 V, 2 ms, 50 $\Omega$	112 V, 50 $\mu$ s, 2 $\Omega$	220 V, 0.15 $\mu$ s, 50 $\Omega$	150 V, 0.15 $\mu$ s, 50 $\Omega$	202 V, 350 ms, 1 pulse	202 V, 350 ms, 10 pulses	202 / --V, 350 ms, 1 $\Omega$	202 / --V, 350 ms, 2 $\Omega$
		(V)				MAX. $R_i$		$U_s$ <sup>(1)</sup>	
SM8S43A	43	-3	56	-3	60	3.50	4.25	55	58
XLD8A24CA + SM8S24A	48	-35	59	-35	63	2.00	2.50	58	60
SM8S24A + SM8S24A	48	-5	64	-5	66	2.00	2.50	65	70

**Note**

<sup>(1)</sup> The XLD8A24CA and SM8S24A in series can clamp under 65 V at a 70 A peak pulse current (Fig.2-6), which can be applied to a single pulse ISO16750-2: 2012 test condition - 202 V, 350 ms, and 2  $\Omega$  condition (Fig.27).

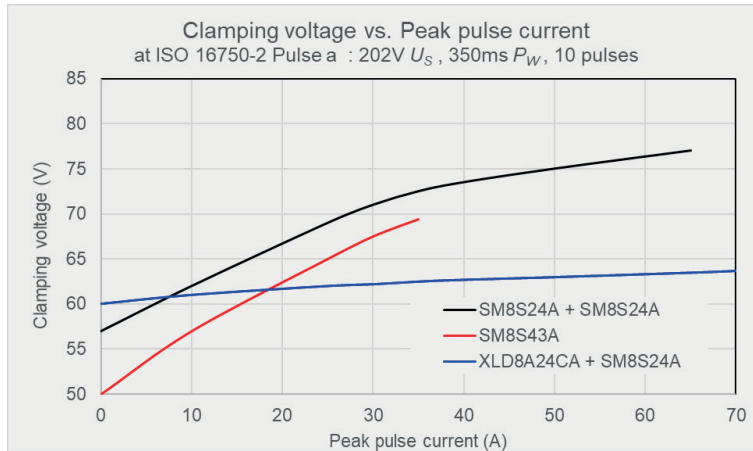

Fig.2-6: Clamping Voltage vs. Peak Pulse Current

The DNA of tech.™

## XClampR™ TVS Application Note

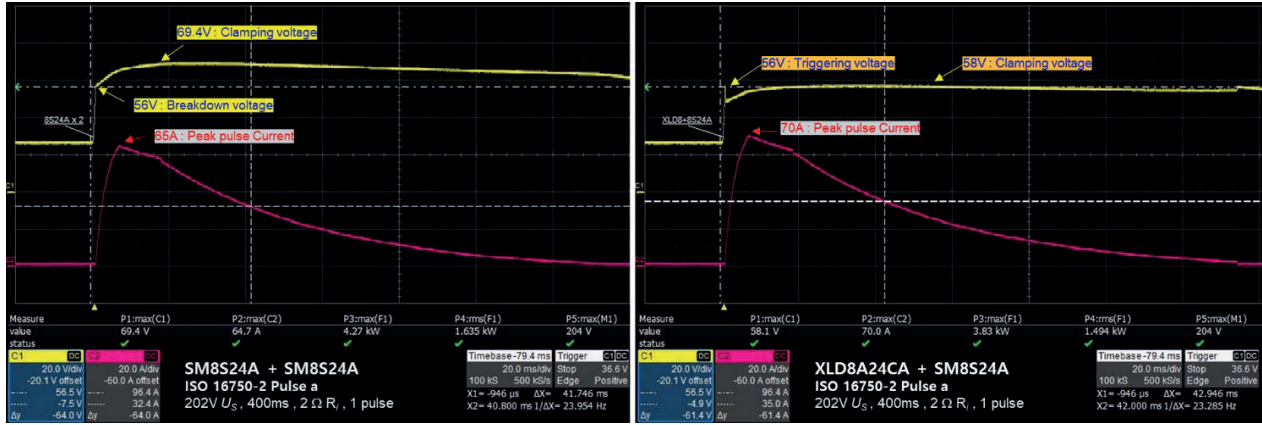

Fig.2-7: Waveforms of the SM8S24A and XLD8A24CA Combination at Load Dump Test

This capability of the XLD8A24CA and SM8S24A applies to 24 V powertrain vehicles equipped with 70 A alternators.

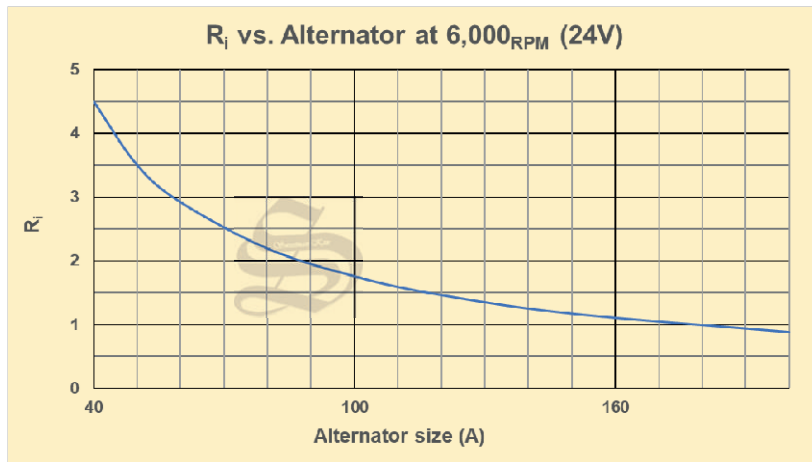

Fig.2-8: 24 V Alternator vs.  $R_i$

### XClampR™ TVS Application Note

#### 2-2. Low voltage DC-Link Capacitor Protection for 48 V Powertrains

In vehicles, the DC-Link capacitor is placed between the power source (alternator or battery) and the AC voltage on the load side (Fig.2-2A). In commercial and industrial electronic equipment, it operates as a load-balancing storage device like a reservoir capacitor. The DC-Link capacitor maintains a stable voltage across the inverter and helps protect the network from high voltage spikes, transients, and EMI noise, which are the results of the pulse inverter current and stray inductance from the DC bus line.

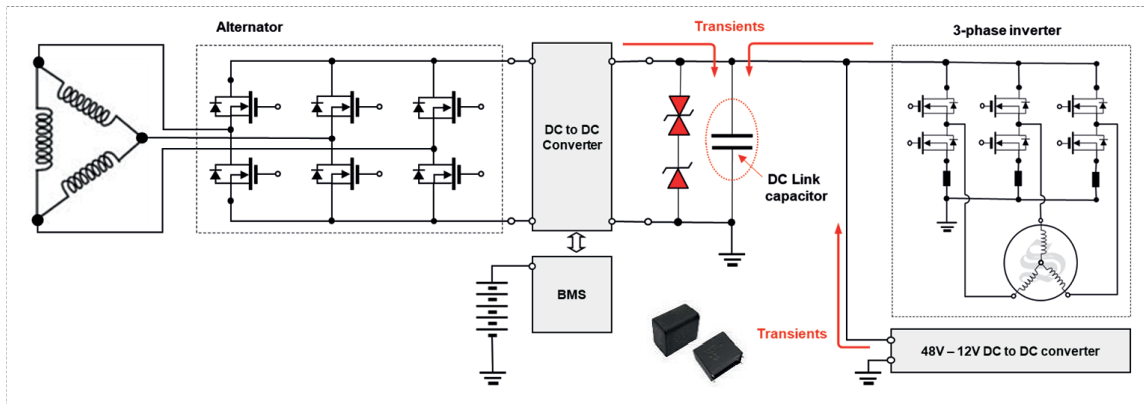

Fig. 2-2A: DC-Link Capacitor Positioning in the Power Line, with Transients

DC-Link capacitors are non-polarized, film devices that absorb bidirectional transients and have a long lifetime to match that of the vehicle refer to [https://www.vishay.com/docs/48164/did-you-know\\_dclink\\_vmn-ms7369.pdf](https://www.vishay.com/docs/48164/did-you-know_dclink_vmn-ms7369.pdf) Bigger than electrolytic capacitors, the devices exhibit weak to high dV/dt and reduce operating voltages in high temperatures, like other types of capacitors.

The capacitance of film capacitors is related to the working voltage, and the maximum capacitance of a 100 V device is 70 % or less than that of the 63 V type. A DC-Link capacitor without enough capacitance will cause a premature failure of vehicle systems due to high ripple voltage in the bus line or EMI interference. Conversely, a device with too much capacitance isn't cost-efficient. A combination of XClampR series and conventional TVS in various stand-off voltages suppresses low clamping voltages over a wide range of peak pulse current to effectively protect DC-Link capacitors

The DNA of tech.™

### XClampR™ TVS Application Note

#### EXAMPLE APPLICATION

In the below figure and table are specifications of for the 63 V Vishay Roederstein MKT1820 series

#### PERMISSIBLE AC VOLTAGE VS. FREQUENCY

AT  $T_{amb} \geq 85\text{ °C}$

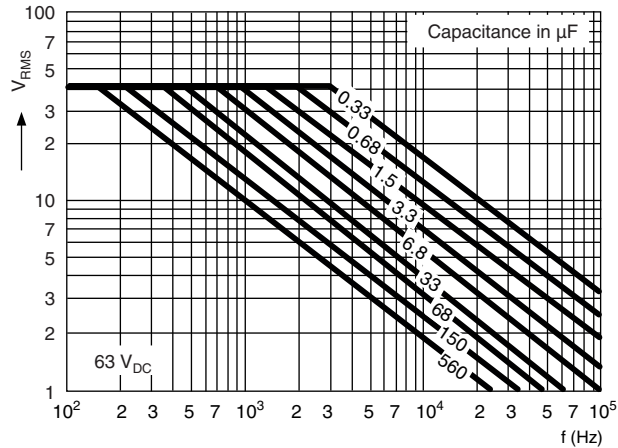

Fig. 2-2B: Permissible AC Voltage

TABLE 2-2A: TYPICAL ALLOWED VOLTAGE CONDITIONS FOR 6 ABOVE			
ALLOWED VOLTAGES	$T_{amb} \leq 85\text{ °C}$	$85\text{ °C} < T_{amb} \leq 100\text{ °C}$	$100\text{ °C} < T_{amb} \leq 125\text{ °C}$
Maximum continuous RMS voltage	$U_{RAC}$	$0.8 \times U_{RAC}$	$0.5 \times U_{RAC}$
Maximum temperature RMS-overvoltage (< 24 h)	$1.25 \times U_{RAC}$	$U_{RAC}$	$0.6 \times U_{RAC}$
Maximum peak voltage ( $V_{O-P}$ ) (< 2 s)	$1.6 \times U_{RDC}$	$1.3 \times U_{RDC}$	$0.5 \times U_{RDC}$

ALLOWED VOLTAGES OF 63 V TYPE VISHAY ROEDERSTEIN MKT1820 - 560 $\mu\text{F}$			
ALLOWED VOLTAGES	$T_{amb} \leq 85\text{ °C}$	$85\text{ °C} < T_{amb} \leq 100\text{ °C}$	$100\text{ °C} < T_{amb} \leq 125\text{ °C}$
Maximum continuous RMS voltage	40	32	20
Maximum temperature RMS-overvoltage (< 24 h)	50	40	24
Maximum peak voltage ( $V_{O-P}$ ) (< 2 s)	101	82	32

The XClampR and conventional TVS combination can provide a stable clamping voltage over a wide temperature range and high current transient conditions for the safe operation of capacitors. Table 2-2B provides the specifications and clamping voltages at different test pulse width combinations. The conventional TVS have big temperature differences due to their temperature coefficient characteristics and high clamping ratio.

APPLICATION NOTE



## XClampR™ TVS Application Note

TABLE 2-2B: XClampR AND CONVENTIONAL TVS COMBINATION FOR A 48 V TO 54 V WORKING VOLTAGE													
PART NUMBER	SPECIFICATION								CLAMPING VOLTAGE AND PEAK CURRENT AT DIFFERENT PULSE WIDTH				
	V <sub>W</sub>	V <sub>BR</sub> AT 25 °C (V)			V <sub>BR</sub> TYP. AT OPERATION TEMPERATURE (°C)				8/20 μs		I <sub>pp</sub> /2 PULSE (A)		
		MIN.	TYP.	MAX.	- 40	25	85	125	V <sub>C</sub>	A	V <sub>C</sub>	1 ms	10 ms
SMC3K54CA	54	60.0	63.1	66.3	60.5	64.5	68.0	70.7	113.0	265.0	87.1	34.4	8.0
XLD8A24CA + SM8S30A	54	57.6	60.5	63.4	57.7	60.5	62.5	63.9	85.0	1400.0	72.4	136.0	107.4
XMC7K24CA + 5KASMC30A	54	60.0	63.2	66.3	60.2	63.2	65.0	66.8	80.0	357.1	72.4	103.3	18.6
XMC7K24CA + 5KASMC13A + 5KASMC16A	53	58.9	62.1	65.1	59.5	62.2	64.5	65.9	78.0	640.0	71.6	180.0	30.0
XLD8A24CA + SMBS28A	52	56.6	59.9	62.4	65.8	59.5	61.5	62.8	82.0	1500.0	69.4	145.0	114.5
XMC7K24CA + 5KASMC28A	52	57.8	60.9	63.9	58.1	60.9	62.5	64.3	77.0	377.4	69.4	110.1	19.8
XMC7K24CA + 5KASMC13A + 5KASMC13A	50	55.5	58.5	61.3	56.1	58.5	60.0	61.3	75.0	760.0	67.2	180.0	30.0
SMC3K48CA	48	53.3	56.1	58.9	52.7	56.1	59.3	61.4	100.0	300.0	77.4	38.8	9.0

Fig. 2-2C shows the clamping voltage of the combinations versus temperature at a 500 A peak or the maximum ratings of the devices at an 8/20 μs test pulse. The clamping voltage of the XMC7K24CA with two 5KASMC13A devices in series at a 500 A, 8/20 μs test pulse at a 85 °C T<sub>A</sub> is lower than 70 V, which is an acceptable voltage for a 63 V DC-Link capacitor.

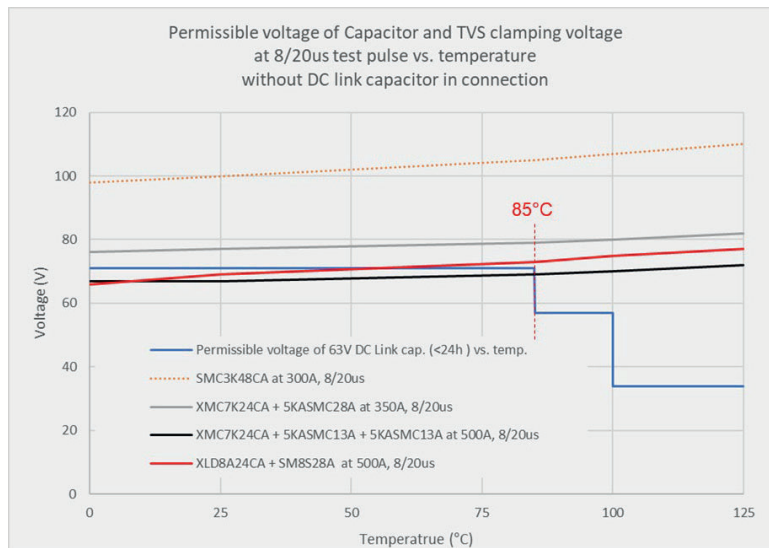

Fig. 2-2C: Clamping Voltage of TVS vs. the Permissible AC Voltage of a DC-Link Capacitor

## XClampR™ TVS Application Note

Fig. 2-2D shows the clamping voltages of TVS combinations at different capacitance values for the DC-Link capacitor.

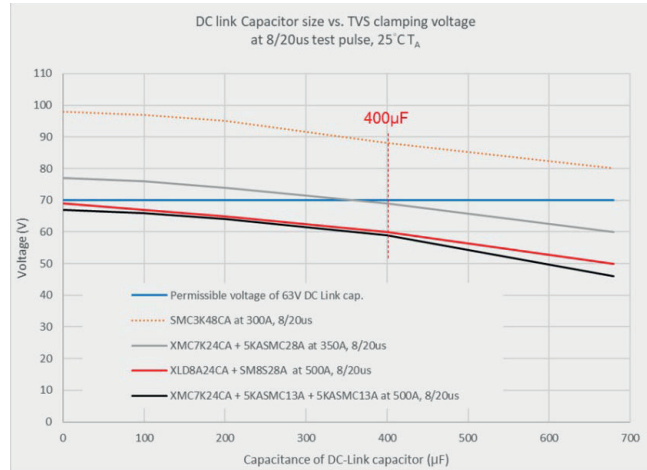

Fig. 2-2D: Clamping Voltage of TVS with DC-Link Capacitors

Fig. 2-2E illustrates the pulse current capability of TVS combinations at different pulse widths with clamping voltages under 70 V. The XMC7K24CA with two 5KASMC13A devices in series has a clamping voltage under 70 V at 10 µs, 500 A, and 10 ms, 40 A transients. The XLD8A24CA and SM8S28A in series have similar clamping voltage at 10 µs, 500 A, and 10 ms, 120 A. This combination can be used in high power inductive load powertrains.

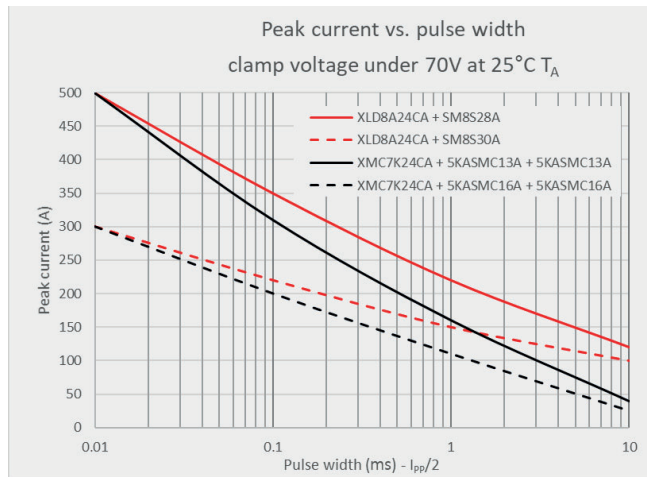

Fig. 2-2E: Peak Current vs. Pulse Width of TVS Combinations

The DNA of tech.™

## XClampR™ TVS Application Note

Fig. 2-2F shows the waveforms of the XMC7K24CA with two 5KASMC13A devices in series at 500 A, 8/20  $\mu$ s, and 10 ms, 40 A pulse width test pulses with a 400  $\mu$ F DC-Link capacitor at 25 °C T<sub>A</sub>.

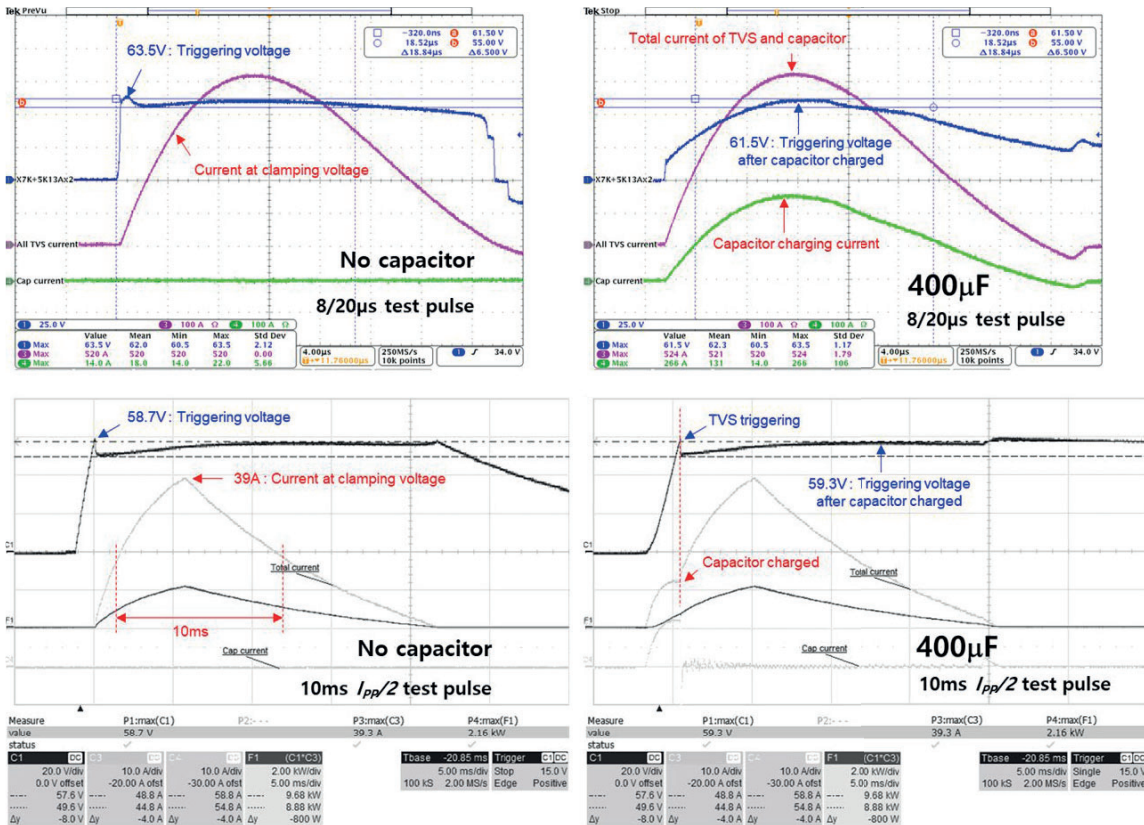

Fig. 2-2F: Waveforms at different conditions for the XMC7K24CA with two 5KASMC13A devices in series

The XClampR and conventional TVS in series can provide various stand-off voltages and very stable clamping voltages to protect DC-Link capacitors.

### XClampR™ TVS Application Note

#### 2-3. DRIVE CIRCUIT PROTECTION FOR ROBOT ARMS AND INDUSTRIAL PURPOSES

Robot arms use several motors for operation and those motors generate transients at start, stop, or high torque in operation. Current in high torque status will reach to stall current, that is very high current than normal operating current and controller stop current supplying, current in motor converted to high voltage as back-EMF.

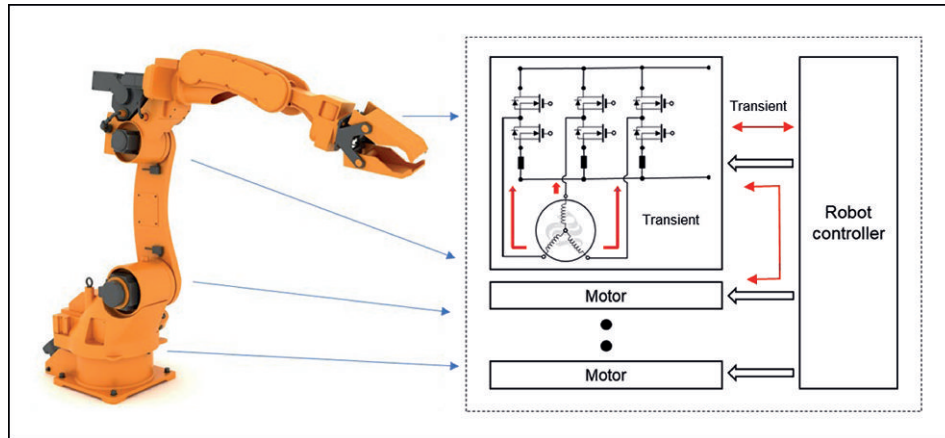

Fig. 2-3A: Typical Block Diagram of a Robot Arm

MOSFETs used in motor driving need to withstand these high voltage transients, but the avalanche capabilities of their body diodes aren't enough; TVS are required. For this type of transient, a 48 V XClampR and conventional TVS combination is needed with clamping voltage over 100 V, as shown in Table 2– 3A.

TABLE 2-3A: XClampR AND CONVENTIONAL TVS COMBINATION FOR A 48 V TO 57 V WORKING VOLTAGE												
PART NUMBER	SPECIFICATION							CLAMPING VOLTAGE AND PEAK CURRENT AT DIFFERENT PULSE WIDTH				
	V <sub>w</sub>	V <sub>BR</sub> AT 25 °C (V)			V <sub>BR</sub> TYP. AT OPERATION TEMPERATURE (°C)			8/20 μs		I <sub>pp</sub> /2 PULSE (A)		
		MIN.	TYP.	MAX.	- 40	25	125	V <sub>C</sub>	A	V <sub>C</sub>	1 ms	10 ms
XMC7K24CA + 5KASMC33A	57	63.4	66.8	70.1	63.6	66.8	70.8	78.0	339.0	74.3	93.8	16.9
SMC3K54CA	54	60.0	63.1	66.3	60.5	64.5	70.7	113.0	265.0	87.1	34.4	8.0
XMC7K24CA + 5KASMC30A	54	60.0	63.2	66.3	60.2	63.2	66.8	74.0	357.1	69.4	103.3	18.6
XMC7K24CA + 5KASMC28A	52	57.8	60.9	63.9	58.1	60.9	64.3	70.0	377.4	66.4	110.1	19.8
SMC3K24CA + SMC3K24CA	48	53.4	56.2	59.0	53.0	56.2	61.1	103.2	581.0	77.8	77.1	18.0
XMC7K24CA + 5KASMC28A	48	53.4	56.2	59.0	53.7	56.2	59.1	65.0	450.0	59.9	128.5	23.1
SMC3K48CA	48	53.3	56.1	58.9	52.7	56.1	61.4	100.0	300.0	77.4	38.8	9.0

Vishay's new XClampR TVS provide low clamping voltage. Circuit designers can use low V<sub>DS</sub> MOSFETs and low working voltage capacitors with XClampR TVS for motor driving circuits in 24 V motors or a XClampR and conventional TVS combination for 48 V motors.

## XClampR™ TVS Application Note

Fig.2-3B illustrates a simplified motor drive circuit without TVS and a transient waveform at the measuring point.

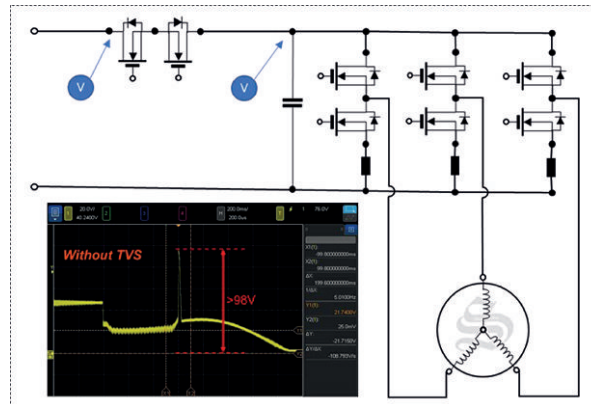

Fig. 2-3B: Motor Drive Circuit Without TVS and Waveform

With transient voltages from other motors on the power line, or back EMF from driving motors, the voltage nearly exceeds 100 V at a 48 V operating voltage. A XClampR and conventional TVS combination suppresses this high voltage to a 60 V level in that condition, as shown in Fig. 2-3C.

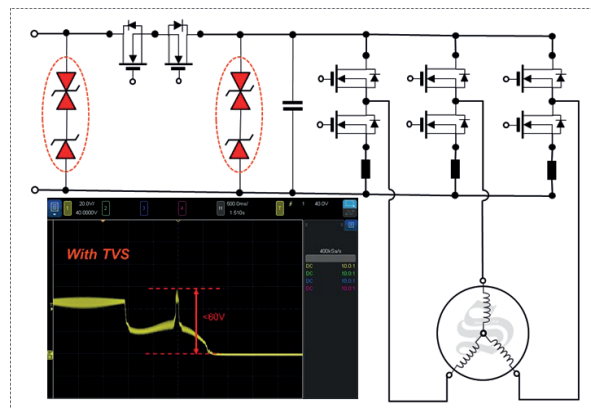

Fig. 2-3C: XMC7K24CA and 5KASMC28A Combination in a Motor Drive Circuit with Waveform

This clamping voltage can only be achieved by the XClampR and conventional TVS with a 48 V power line. As shown in Table 2-3A, the combination can also provide variable clamping voltages to accommodate different requirements. Fig. 2-3D and Fig. 2-3E capture the waveforms of the XMC7K24CA and 5KASMC28A in a series connection at 8/20  $\mu$ s and 10 ms  $I_{pp}/2$  transient pulses.



## XClampR™ TVS Application Note

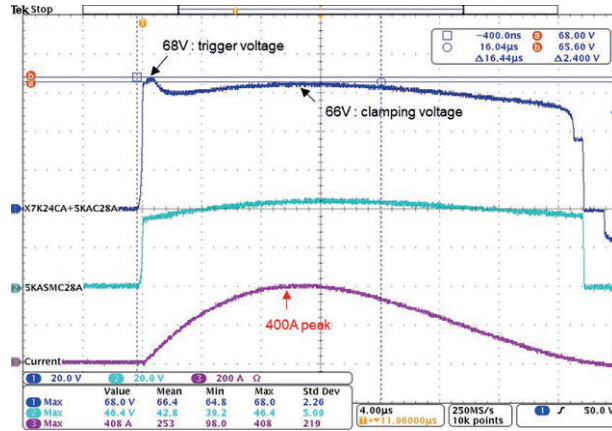

Fig. 2-3D: XMC7K24CA and 5KASMC28A Combination at a 400 A, 8/20 μs Pulse Width

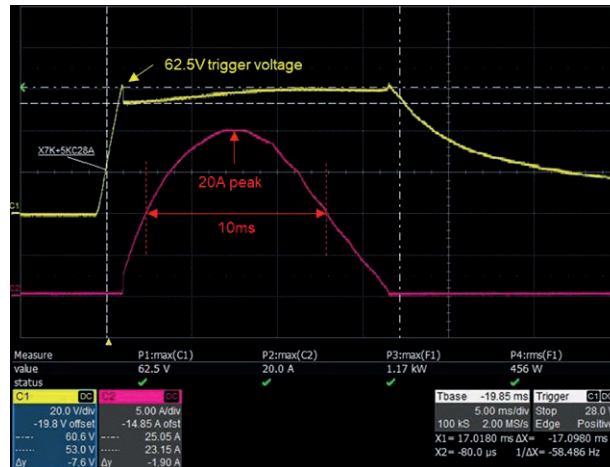

Fig. 2-3E: XMC7K24CA and 5KASMC28A combination at a 20 A, 10 ms IPP/2 pulse width

This XMC7K24CA and 5KASMC28A combination provides clamping voltage under 70 V at 25 °C T<sub>A</sub> and maximum ratings, as shown in Table 2-3A.



The DNA of tech.™

## XClampR™ TVS Application Note

### CONCLUSION

As more electronic devices become a part of everyday life, the demand for their safe and stable operation will inevitably increase. Vishay's XClampR TVS series can meet that demand.

### ADVANTAGES OF XClampR TVS

XClampR TVS can provide the following advantages to help designers of cost-effective circuits utilizing lower VDS MOSFETs and lower working voltage capacitors without TVS applied. In addition, the devices characteristics translate into an accurate and high reliability protection solution.

- Low clamping ratio at a wide range of peak pulse currents at the clamping voltage
- Low clamping voltage at high transient current
- Stable breakdown voltage over wide operating temperature ranges
- High clamping peak pulse current capability in the same packages

### ROADMAP OF XClampR TVS

Currently, XClampR are only available with a 24 V stand-off voltage, although other clamping voltages can be achieved by combining the devices with conventional TVS. In the near future, Vishay will be extending the series with clamping voltages up to 110 V and various package options for safety applications.

### Acknowledgements

I would like to express my deep gratitude to:

- Vincent Lin for his guidance
- Massimo Carbone and Avery Ren for editing
- Ivan Chen, Dinah Liu, Winnie Chang, and Fany Fan in Product Marketing and Engineering for providing necessary support
- HP. Tsai, Warren Chiang, Johnny Chiang, and Kevin Yang of the Research and Development team for their expertise